

**10/100/1000BASE-T to 100/1000BASE-X SFP  
Managed Media Converter**

**GT-915A**

Quick Installation Guide

# Table of Contents

1. Package Contents .....	3
2. Requirements .....	4
3. Starting Web Management .....	5
3.1 Logging in to the Managed Media Converter.....	5
3.2 Saving Configuration via Web .....	8
4. Recovering Back to Default Configuration.....	10
5. Customer Support .....	11

## 1. Package Contents

Thank you for purchasing PLANET 10/100/1000BASE-T to 100/1000BASE-X SFP Managed Media Converter, GT-915A. **“Managed Media Converter”** mentioned in this Guide refers to the GT-915A.

Open the box of the Managed Media Converter and carefully unpack it. The box should contain the following items:

GT-915A	
The Managed Media Converter	■
Quick Start QR code sheet	■
DC 5V/2A Power Adapter	■
SFP Dust Cap	1

If any of these are missing or damaged, please contact your dealer immediately. If possible, retain the carton including the original packing materials to enable you to repack the product in case there is a need to return it to us for repair.

## 2. Requirements

The Managed Media Converter provides remote Web interface for management purposes; the following products are necessary for further management.

- **Workstations** running Windows 7/8/10/11, macOS 10.12 or later, Linux Kernel 2.6.18 or later, or other modern operating systems are compatible with TCP/IP Protocols.
- Workstations are installed with Ethernet NIC (Network Interface Card).
- **Ethernet Port Connection**
  - **Network cables** -- Use standard network (UTP) cables with RJ45 connectors.
  - The above PC is installed with **Web browser**.



Note

It is recommended to use Google Chrome, Microsoft Edge or Mozilla Firefox to access the Managed Media Converter.



Note

If the Web interface of the Managed Media Converter is not accessible, please turn off the anti-virus software or firewall and then try it again.

### 3. Starting Web Management

The following shows how to start up the **Web Management** of the Managed Media Converter. Note the Managed Media Converter is configured through an Ethernet connection. Please make sure the manager PC must be set to the same **IP subnet address**.

For example, the default IP address of the Managed Media Converter is **192.168.0.100**, then the manager PC should be set to **192.168.0.x** (where x is a number between 1 and 254, except 100), and the default subnet mask is 255.255.255.0.

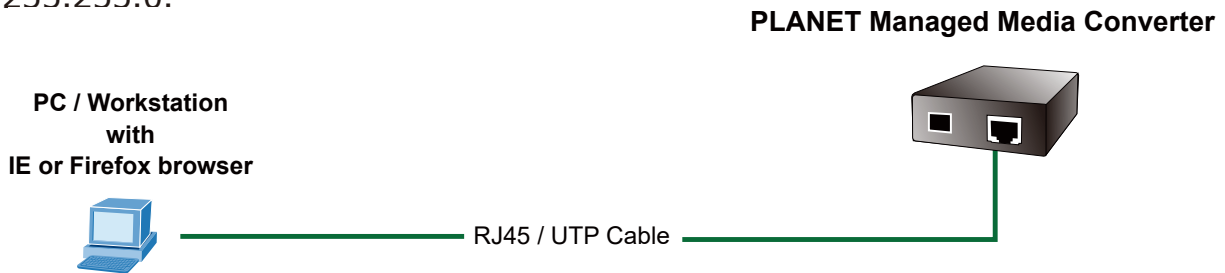

#### 3.1 Logging in to the Managed Media Converter

■ The following web screen is based on the firmware version before May 2024.

Use your preferred web browser such as Chrome, Edge, Firefox, etc. and enter the default IP address **https://192.168.0.100** to access the Web interface.

When the following login screen appears, please enter the default username **"admin"** and password **"admin"** (or the password you have changed before). Press **"Login"** to enter the main screen of GT-915A. The login screen in Figure 3-1 appears.

Default IP Address: **192.168.0.100**  
Default Account: **admin**  
Default Password: **admin**

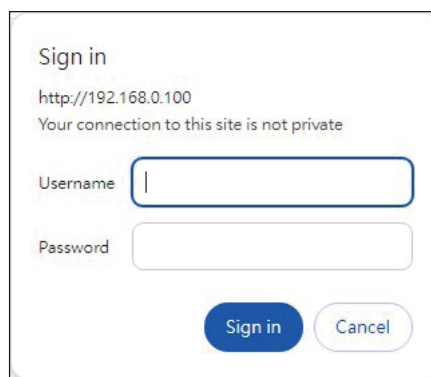
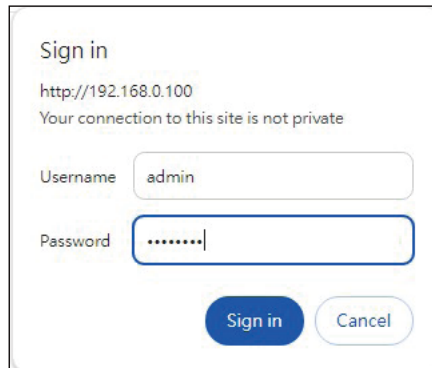

Figure 3-1: Web Login Screen of Managed Media Converter

■ The following web screen is based on the firmware version of May 2024 or after. When the following dialog box appears, please enter the default user name "admin" and password. Refer to **Figure 3-3** to determine your initial login password.



**Figure 3-2:** Login Screen

Default Username: **admin**  
Default Password: **mc + the last 6 characters of the MAC ID in lowercase**

Find the MAC ID on your device label. The default password is "mc" followed by the last six lowercase characters of the MAC ID.

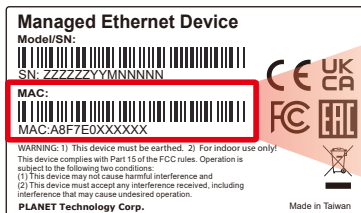

MAC ID: A8F7E0XXXXXX  
Default Password: mcxxxxxx  
("x" means the last 6 digits of the MAC address.  
All characters should be in lowercase.)

**Figure 3-3:** MAC ID Label

After logging in, you will be prompted to change the initial password to a permanent one.

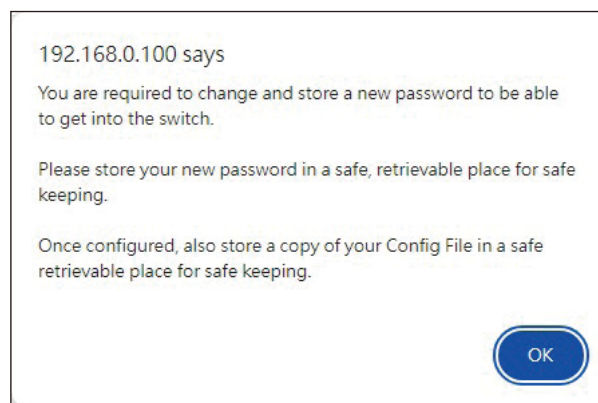

**Figure 3-4:** Message to change the password

**Change Password**

New Password	
<b>Password</b>	<input type="password"/> <input type="checkbox"/> show password
<b>Retype Password</b>	<input type="password"/>

The Password must contain 8 to 31 characters, including uppercase, lowercase and other symbols and other symbols.  
 Symbols like | \ ; ? " & < > ( ) and ` cannot be used. Please note, spaces (blanks) are not accepted.

**Figure 3-5: Password Change Screen**



Note

The Password must contain 8 to 31 characters, including uppercase, lowercase, numerals and other symbols. Symbols like | ` \ ; ? " & < > ( ) and ` cannot be used. Please note, spaces (blanks) are not accepted.

Once the password change is completed, re-enter the web interface using your new password.

Sign in

http://192.168.0.100  
Your connection to this site is not private

Username

Password

**Figure 3-6: Login Screen**

After entering the user name and password, the Web main screen appears as in Figure 3-7 after the login.

**Welcome to PLANET**

**GT-915A**

**1-Port 10/100/1000T + 1-Port 100/1000X SFP**

**Managed Media Converter**

**PLANET Technology Corporation**

11F., No.96, Minquan Rd., Xindian Dist., New Taipei City 231, Taiwan (R.O.C.)  
 Tel: 886-2-2219-9518  
 Fax: 886-2-2219-9528  
 Email: [Support@planet.com.tw](mailto:Support@planet.com.tw)

Copyright©2022 PLANET Technology Corporation. All rights reserved.

**Figure 3-7: Web Main Screen of Managed Media Converter**

The Menu on the top of the Web page lets you access all the commands and statistics the Managed Media Converter provides. The Menu always contains one or more buttons, such as **“System”**, **“Switching”**, **“QoS”**, **“Security”** and **“Maintenance”**.



Figure 3-8: Main Menu

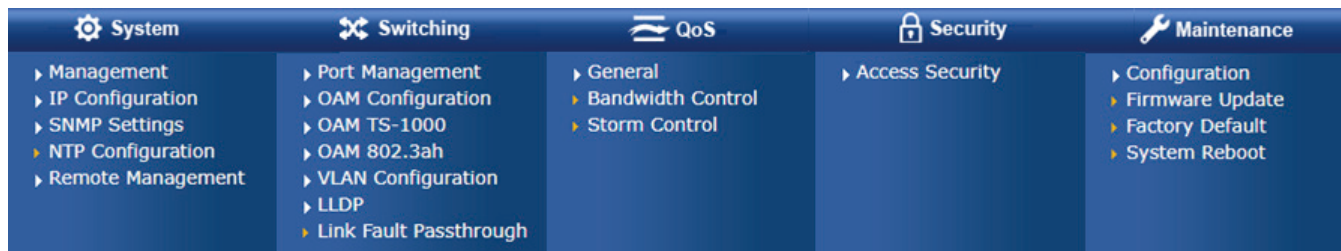

Figure 3-9: Sub-menu

Now, you can use the Web management interface to continue the Managed Media Converter management. Please refer to the user manual for more.

Note

1. For security reason, **please change and memorize the new password after this first setup.**
2. Only accept command in lowercase letter under web interface.

### 3.2 Saving Configuration via Web

To save all applied changes and set the current configuration as a startup configuration, the startup-configuration file will be loaded automatically across a system reboot.

1. Click the Save icon on the top Menu bar.

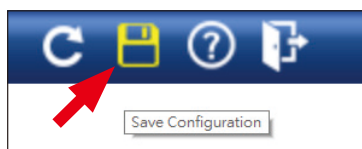

2. Press the **“Save Configuration”** button.

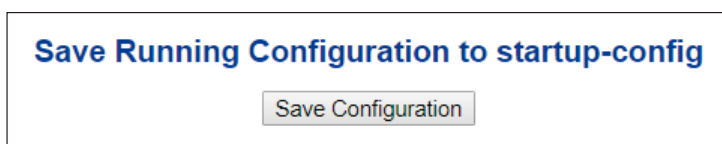



3. Or the other way to save the setting is to Click **Maintenance, Save Startup Config.**

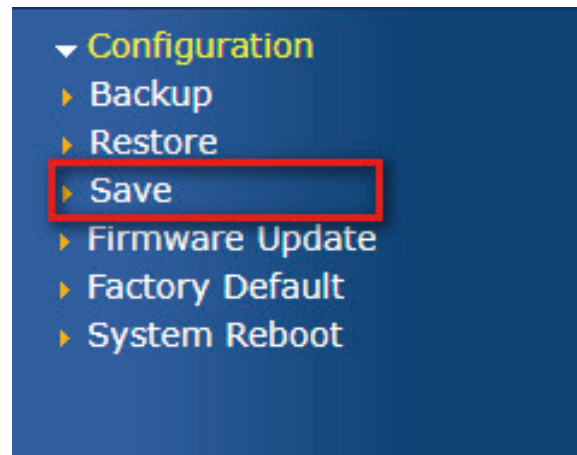

## 4. Recovering Back to Default Configuration

**IP address has been changed or admin password has been forgotten –**

To reset the IP address to the default IP Address “**192.168.0.100**” or reset the login password to default value, press the hardware-based reset button on the front panel for about **10 seconds**. After the device is rebooted, you can log in the management Web interface within the same subnet of 192.168.0.xx.

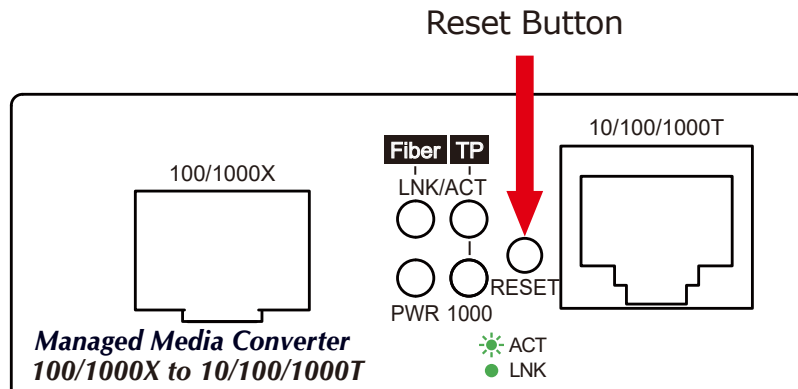

## 5. Customer Support

Thank you for purchasing PLANET products. You can browse our online FAQ resource and User's Manual on PLANET Web site first to check if it could solve your issue. If you need more support information, please contact PLANET Media Converter support team.

PLANET online FAQs:

<https://www.planet.com.tw/en/support/faq>

Media Converter support team mail address:

[support@planet.com.tw](mailto:support@planet.com.tw)

GT-915A User's Manual:

[https://www.planet.com.tw/dl/user\\_manual/gt-915a](https://www.planet.com.tw/dl/user_manual/gt-915a)



(Please select your Media Converter model name from the Product Model drop-down menu.)

Copyright © PLANET Technology Corp. 2024

Contents are subject to revision without prior notice.

PLANET is a registered trademark of PLANET Technology Corp.

All other trademarks belong to their respective owners.