

L2+ 24-Port 10/100/1000T Ultra PoE + 4-Port 10G SFP+ Managed Switch with LCD Touch Screen (400W/600W)

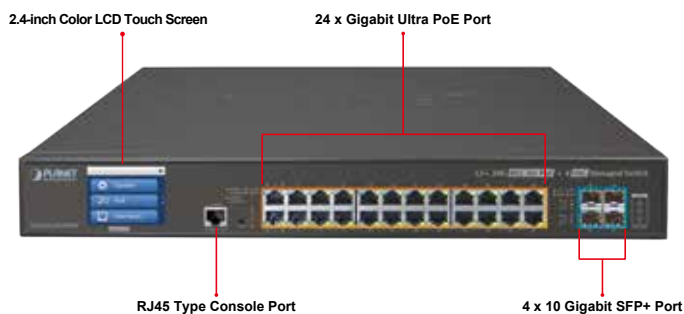

Amazing Ultra PoE Managed Switches with Advanced L2+/L4 Switching and Security

PLANET GS-5220-24UP4XV(R) and GS-5220-24UPL4XV(R) are cost-optimized, 1.25U, Gigabit Ultra PoE Managed Switches with LCD Touch Screen featuring PLANET intelligent PoE functions to improve the availability of critical business applications. They provide IPv6/IPv4 dual stack management and built-in L2+/L4 Gigabit switching engine along with 24 10/100/1000BASE-T ports featuring 75-watt Ultra PoE and 4 additional 10Gigabit SFP+ ports. With a total power budget of up to 400/600 watts for different kinds of PoE applications, the GS-5220-24UP4XV(R) and GS-5220-24UPL4XV(R) provide a quick, safe and cost-effective ultra PoE network solution for small businesses and enterprises.



Smart and Intuitive LCD Control

PLANET unique Smart LCD PoE Switches provide intuitive touch panel on its front panel that facilitates the Ethernet management and PoE PD management. They greatly promote management efficiency in large-scale network, such as enterprises, hotels, shopping malls, government buildings, and other public areas, and feature the following special management and status functions:

- IP address, VLAN and QoS configuration
- PoE management and status
- Port management and status/SFP information
- Troubleshooting: cable diagnostic and remote IP ping
- Maintenance: reboot, factory default and save configuration

Physical Port

- 24 10/100/1000BASE-T Gigabit RJ45 copper ports with 24-port IEEE 802.3af/at/bt Ultra PoE injector
- 4 10GBASE-SR/LR SFP+ slots, compatible with 1000BASE-SX/LX/BX SFP
- RJ45 console interface for switch basic management and setup

Power over Ethernet

- Complies with IEEE 802.3at Power over Ethernet Plus, end-span/mid-span PSE
- Backward compatible with IEEE 802.3af Power over Ethernet
- Up to 24 ports of IEEE 802.3af/IEEE 802.3at/IEEE 802.3bt ultra PoE devices powered
- Supports PoE power up to 75 watts for each ultra PoE port
- Auto detects powered device (PD)
- Circuit protection prevents power interference between ports
- Remote power feeding up to 100 meters
- PoE management
 - Total PoE power budget control
 - Per port PoE function enable/disable
 - PoE admin-mode control
 - PoE port power feeding priority
 - Per PoE port power limitation
 - PD classification detection
 - Temperature threshold control
 - PD alive check
 - PoE schedule

Layer 2 Features

- Prevents packet loss with back pressure (half-duplex) and IEEE 802.3x pause frame flow control (full-duplex)
- High performance of Store-and-Forward architecture and runt/CRC filtering eliminates erroneous packets to optimize the network bandwidth
- Storm Control support
 - Broadcast/Multicast/Unknown unicast
- Supports VLAN
- IEEE 802.1Q tagged VLAN
 - Up to 255 VLANs groups, out of 4094 VLAN IDs
 - Supports provider bridging (VLAN Q-in-Q, IEEE 802.1ad)
 - Private VLAN Edge (PVE)
 - Protocol-based VLAN
 - MAC-based VLAN
 - Voice VLAN
- Supports Spanning Tree Protocol
 - IEEE 802.1D Spanning Tree Protocol



Convenient and Smart ONVIF Devices with Detection Feature

PLANET has newly developed an awesome feature -- ONVIF Support -- which is specifically designed for co-operating with Video IP Surveillances. From the GS-5220-24UP4XV(R) and GS-5220-24UPL4XV(R) GUI, clients just need one click to search and show all of the ONVIF devices via network application. In addition, clients can upload floor images into switch and allows for deploying location of surveillance devices for easier inspection and planning. Moreover, clients can get real-time surveillance's information and online/offline status, and also allows PoE reboot control from GUI.



- IEEE 802.1w Rapid Spanning Tree Protocol
- IEEE 802.1s Multiple Spanning Tree Protocol, spanning tree by VLAN
- BPDU Guard
- Supports Link Aggregation
 - 802.3ad Link Aggregation Control Protocol (LACP)
 - Cisco ether-channel (static trunk)
 - Maximum 14 trunk groups, up to 4 ports per trunk group
 - Up to 80Gbps bandwidth (full duplex mode)
- Provides port mirror (many-to-1)
- Port mirroring to monitor the incoming or outgoing traffic on a particular port
- Loop protection to avoid broadcast loops

Layer 3 Features

- IP interfaces (Max. 8 VLAN interfaces)
- Routing table (Max. 32 routing entries)
- Routing Protocols (IPv4/IPv6 software static routing)

Quality of Service

- Ingress Shaper and Egress Rate Limit per port bandwidth control
- 8 priority queues on all switch ports
- Traffic classification
 - IEEE 802.1p CoS
 - TOS/DSCP/IP precedence of IPv4/IPv6 packets
 - IP TCP/UDP port number
 - Typical network application
- Strict priority and Weighted Round Robin (WRR) CoS policies
- Supports QoS and In/Out bandwidth control on each port
- Traffic-policing on the switch port
- DSCP remarking

Multicast

- Supports IGMP snooping v1, v2 and v3
- Supports MLD snooping v1 and v2
- Querier mode support
- IGMP snooping port filtering
- MLD snooping port filtering
- Multicast VLAN Registration (MVR) support

Security

- Authentication
 - IEEE 802.1x port-based/MAC-based network access authentication
 - Built-in RADIUS client to cooperate with the RADIUS servers
 - TACACS+ login users access authentication
 - RADIUS/TACACS+ users access authentication
- Access Control List
 - IP-based Access Control List (ACL)
 - MAC-based Access Control List
- Source MAC/IP address binding
- DHCP Snooping to filter untrusted DHCP messages
- Dynamic ARP Inspection discards ARP packets with invalid

75 Watts of Power over 4-pair UTP

The GS-5220-24UP4XV(R) and GS-5220-24UPL4XV(R) ultra PoE solutions adopt the IEEE 802.3at/af standard. Instead of delivering power over 2-pair twisted UTP – be it end-span (Pins 1,2,3 and 6) or mid-span (Pins 4,5,7 and 8), they provide the capability to source up to 75 watts of power by using all the four pairs of standard Cat.5e/6 Ethernet cabling. In the new 4-pair system, two PSE controllers will be used to power both the data pairs and the spare pairs. It can offer more PoE applications, such as:

- PoE PTZ speed dome
- Any network device that needs higher PoE power to work normally
- Thin-client
- AIO (All-in-One) touch PC
- Remote digital signage display



Built-in Unique PoE Functions for Powered Devices Management
 Being the managed PoE switches for surveillance, wireless and VoIP networks, the GS-5220-24UP4XV(R) and GS-5220-24UPL4XV(R) feature the following special PoE management functions:

- PD alive check
- Scheduled power recycling
- PoE schedule
- PoE usage monitoring

Intelligent Powered Device Alive Check

The GS-5220-24UP4XV(R) and GS-5220-24UPL4XV(R) can be configured to monitor connected PD (powered device) status in real time via ping action. Once the PD stops working and responding, the GS-5220-24UP4XV(R) and GS-5220-24UPL4XV(R) will resume the PoE port power and bring the PD back to work. They will greatly enhance the network reliability through the PoE port resetting the PD's power source and reducing administrator management burden.

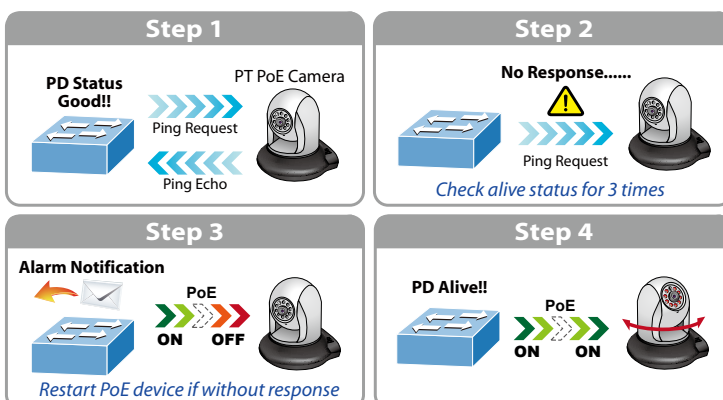

MAC address to IP address binding

- IP Source Guard prevents IP spoofing attacks
- IP address access management to prevent unauthorized intruder

Management

- IPv4 and IPv6 dual stack management
- Switch Management Interfaces
 - Console/Telnet Command Line Interface
 - Web switch management
 - SNMP v1, v2c, and v3 switch management
 - SSH/SSL secure access
 - 2.4-inch color LCD touch screen
- IPv6 IP address/NTP/DNS management
- Built-in Trivial File Transfer Protocol (TFTP) client
- BOOTP and DHCP for IP address assignment
- System Maintenance
 - Firmware upload/download via HTTP/TFTP
 - Reset button for system reboot or reset to factory default
 - Dual images
- DHCP Relay
- DHCP Option 82
- User Privilege levels control
- NTP (Network Time Protocol)
- Link Layer Discovery Protocol (LLDP) and LLDP-MED
- Network Diagnostic
 - ICMPv6/ICMPv4 remote ping
 - Cable diagnostic technology provides the mechanism to detect and report potential cabling issues
- SMTP/Syslog remote alarm
- Four RMON groups (history, statistics, alarms and events)
- SNMP trap for interface Link Up and Link Down notification
- System Log
- PLANET Smart Discovery Utility for deployment management
- Smart fan with speed control

Redundant Power System (GS-5220-24UP(L)4XV(R))

- Redundant 100~240V AC/36-60V DC dual power
- Active-active redundant power failure protection
- Backup of catastrophic power failure on one supply
- Fault tolerance and resilience

Scheduled Power Recycling

The GS-5220-24UP4XV(R) and GS-5220-24UPL4XV(R) allow each of the connected PoE IP cameras or PoE wireless access points to reboot at a specified time each week. Therefore, they will reduce the chance of IP camera or AP crash resulting from buffer overflow.

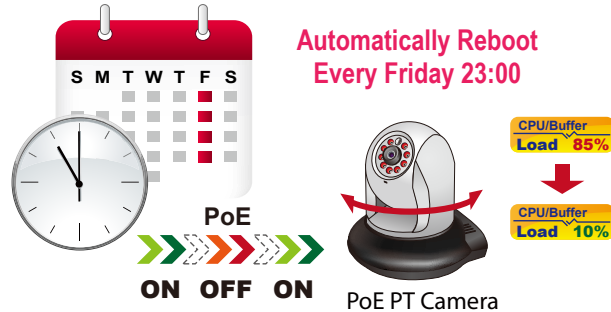

PoE Schedule for Energy Saving

Under the trend of energy saving worldwide and contributing to environmental protection, the GS-5220-24UP4XV and GS-5220-24UP4XVR can effectively control the power supply besides their capability of giving high watts power. The “PoE schedule” function helps you to enable or disable PoE power feeding for each PoE port during specified time intervals and it is a powerful function to help SMBs or enterprises save power and money. It also increases security by powering off PDs that should not be in use during non-business hours.

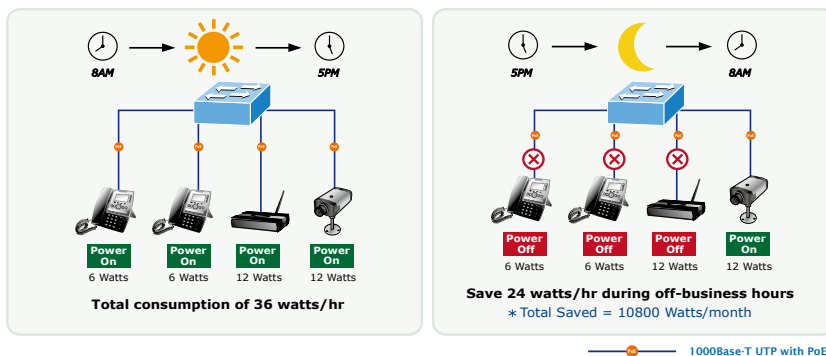

PoE Usage Monitoring

Via the power usage chart in the web management interface, the GS-5220-24UP4XV(R) and GS-5220-24UPL4XV(R) enable the administrator to monitor the status of the power usage of the connected PDs in real time. Thus, it greatly enhances the management efficiency of the facilities.

Cost-effective 10Gbps Uplink Capacity

10G Ethernet is a big leap in the evolution of Ethernet. The four 10G SFP+ slots of the GS-5220-24UP4XV(R) and GS-5220-24UPL4XV(R) support dual-speed 10GBASE-SR/LR or 1000BASE-SX/LX, meaning the administrator now can flexibly choose the suitable SFP/SFP+ transceiver according to the transmission distance or the transmission speed required to extend the network efficiently. They greatly support SMB network to achieve the maximum performance of 10Gbps in a cost-effective way because the 10GbE interface usually could be available in Layer 3 Switch but Layer 3 Switch could be too expensive to SMBs.

Redundant AC/DC Power Supply to Ensure Continuous Operation

The GS-5220-24UP4XVR and GS-5220-24UPL4XVR are particularly equipped with one 100~240V AC power supply unit and one 36~60V DC power supply unit to provide an enhanced reliable and scalable redundant power supply. The continuous power system is specifically designed to fulfill the demands of high-tech facilities requiring the highest power integrity. With the 36~60V DC power supply, the GS-5220-24UP4XVR and GS-5220-24UPL4XVR are able to act as a telecom-level device that can be located in the electronic room.



Environment-friendly, Smart Fan Design for Silent Operation

The GS-5220-24UP4XV(R) and GS-5220-24UPL4XV(R) feature a 19-inch metal housing, a low noise design and an effective ventilation system. It supports the smart fan technology that automatically controls the speed of the built-in fan to reduce noise and maintain the temperature of the PoE switch for optimal power output capability. The GS-5220-24UP4XV(R) and GS-5220-24UPL4XV(R) are able to operate reliably, stably and quietly in any environment without affecting its performance.

Solution for IPv6 Networking

By supporting IPv6/IPv4 dual stack and plenty of management functions with easy and friendly user interfaces, the GS-5220-24UP4XV(R) and GS-5220-24UPL4XV(R) are the best choices for IP surveillance, VoIP and wireless service providers to deploy the IPv6 network. It also helps the SMBs to step in the IPv6 era with the lowest investment but not necessary to replace the network facilities while the ISPs construct the IPv6 FTTx edge network.

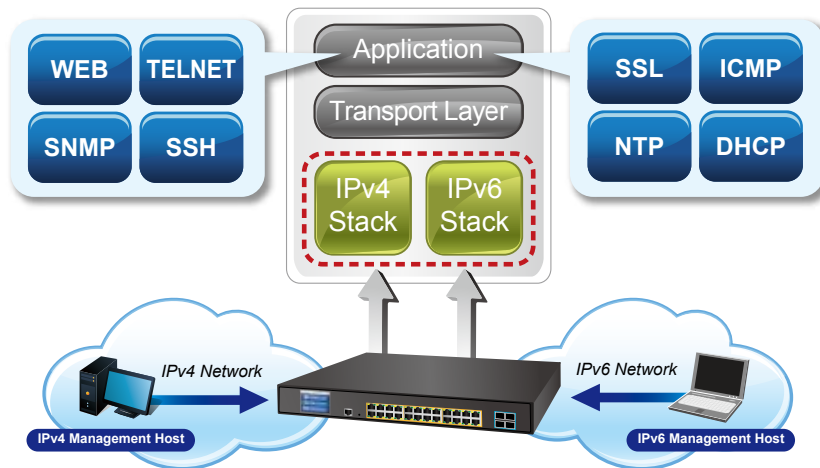

IPv4 and IPv6 VLAN Routing for Secure and Flexible Management

To help customers stay on top of their businesses, the GS-5220 switch series not only provides ultra high transmission performance and excellent Layer 2 technologies, but also offers IPv4/IPv6 VLAN routing feature which allows to cross over different VLANs and different IP addresses for the purpose of having a highly-secure, flexible management and simpler networking application.

Robust Layer 2 Features

The GS-5220 series can be programmed for advanced switch management functions, such as dynamic port link aggregation, Q-in-Q VLAN, Multiple Spanning Tree Protocol (MSTP), Layer 2/4 QoS, bandwidth control and IGMP/MLD snooping. The SGS-5220 series allows the operation of a high-speed trunk combining multiple ports. It consists of a maximum of 14 trunk groups with 4 ports for each group, and supports connection fail-over as well.

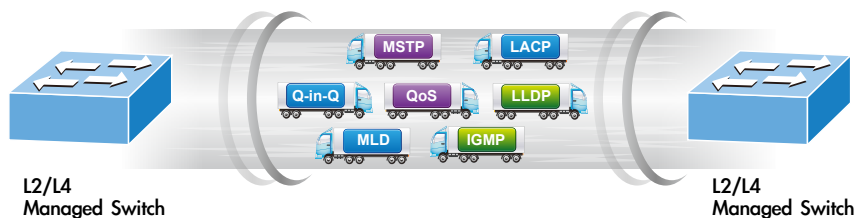

Powerful Security

The GS-5220 series offers a comprehensive Layer 2 to Layer 4 access control list (ACL) for enforcing security to the edge. It can be used to restrict to network access by denying packets based on source and destination IP address, TCP/UDP port number or defined typical network applications. Its protection mechanism also comprises 802.1x Port-based and MAC-based user and device authentication. With the private VLAN function, communication between edge ports can be prevented to ensure user privacy.

Enhanced Security and Traffic Control

The GS-5220 series also provides DHCP Snooping, IP Source Guard and Dynamic ARP Inspection functions to prevent IP snooping from attack and discard ARP packets with invalid MAC address. The network administrator can now construct highly-secure corporate networks with considerably less time and effort than before.

User-friendly Secure Management

For efficient management, the GS-5220 managed switch series is equipped with console, web and SNMP management interfaces. With the built-in web-based management interface, the GS-5220 series offers an easy-to-use, platform independent management and configuration facility. The GS-5220 series supports SNMP and it can be managed via any management software based on the standard SNMP v1 or v2 Protocol. For reducing product learning time, the GS-5220 series offers Cisco-like command via Telnet or console port and customer doesn't need to learn new command from these switches. Moreover, the GS-5220 series offers the remotely secure management by supporting SSH, SSL and SNMP v3 connection where the packet content can be encrypted at each session.



Intelligent SFP/SFP+ Diagnosis Mechanism

The GS-5220-24UP4XV(R) and GS-5220-24UPL4XV(R) support SFP-DDM (Digital Diagnostic Monitor) function that greatly helps network administrator to easily monitor real-time parameters of the SFP and SFP+ transceivers, such as optical output power, optical input power, temperature, laser bias current, and transceiver supply voltage.

Digital Diagnostic Monitor (DDM)

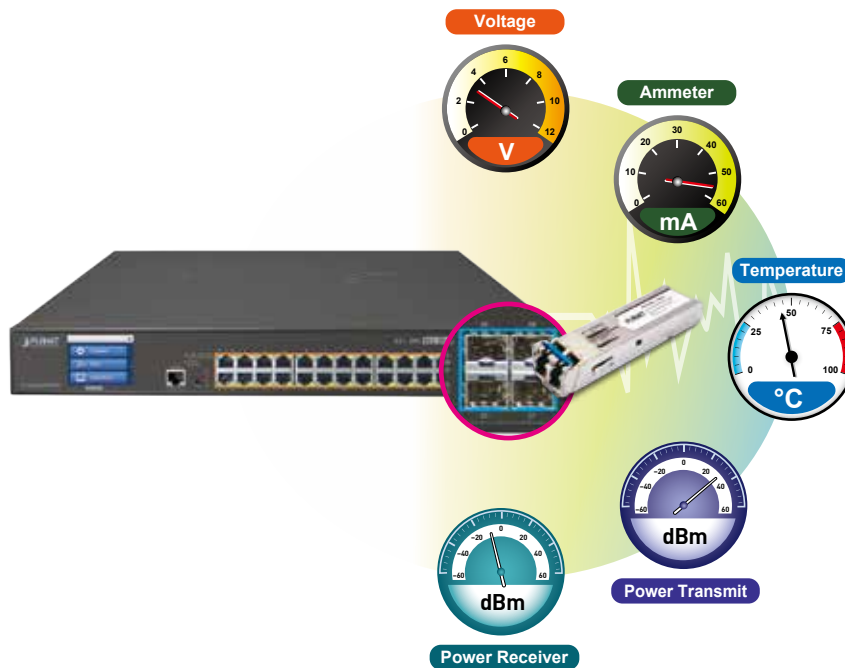

Applications

Ultra PoE Networking Solution

PLANET GS-5220-24UP4XV(R) and GS-5220-24UPL4XV(R) can easily build an ultra PoE networking solution on the cyber security system for the enterprises. For instance, it can work with the POS system and thin client to perform comprehensive security protection for today's businesses. The GS-5220-24UP4XV(R), GS-5220-24UPL4XV(R) and POE-171S/IPOE-171S Ultra PoE Splitter operate as a pair to provide the easiest way to power your Ethernet devices which need high power input. Receiving data and power from the GS-5220-24UP4XV(R) and GS-5220-24UPL4XV(R), the POE-171S/IPOE-171S separates digital data and power into several optional outputs (12V, 19V or 24V DC) to non-PoE devices such as laptops, thin client, POS system, PTZ (Pan, Tilt & Zoom) network cameras, PTZ speed dome, color touch-screen IP phones, multi-channel wireless LAN access points and other network devices at distance up to 100 meters.

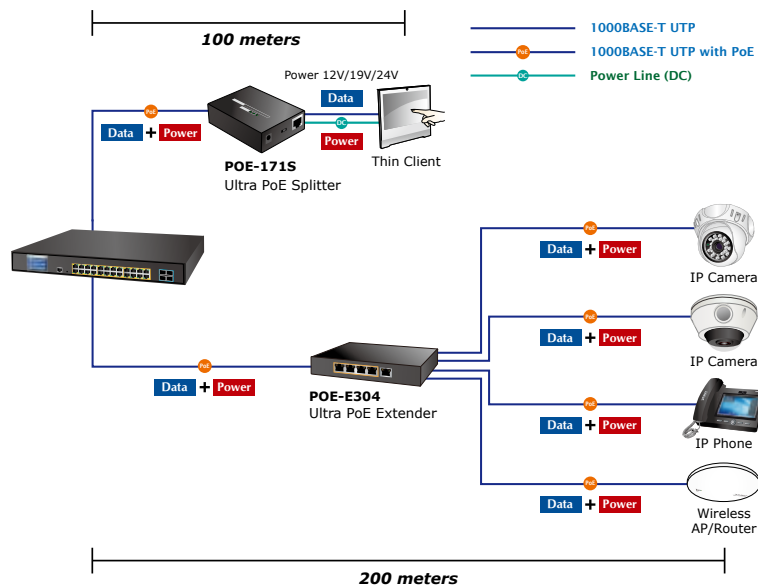

Multiple Spanning Tree Protocol with PoE IP Office Solution for SMBs and Workgroups

The GS-5220-24UP4XV(R) and GS-5220-24UPL4XV(R) feature strong, rapid self-recovery capability to prevent interruptions and external intrusions. They incorporate Multiple Spanning Tree Protocol (802.1s MSTP) into customer's automation network to enhance system reliability and uptime. Adopting the IEEE 802.3af/802.3at/802.3bt Ultra PoE standard, the GS-5220-24UP4XV(R) and GS-5220-24UPL4XV(R) can directly connect with any IEEE 802.3at/ultra PoE end-nodes like PTZ (Pan, Tilt & Zoom) network cameras and speed dome cameras. The GS-5220-24UP4XV(R) and GS-5220-24UPL4XV(R) can easily help enterprises with the available network infrastructure to build wireless AP, IP camera and VoIP systems where power can be centrally-controlled.

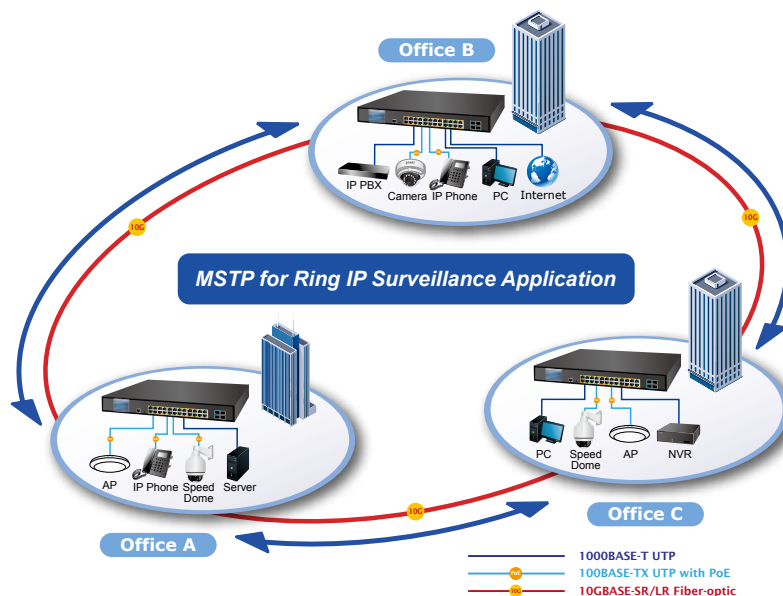

Specifications

| Product | GS-5220-24UP4XV | GS-5220-24UP4XVR | GS-5220-24UPL4XV | GS-5220-24UPL4XVR |
|-------------------------------------|---|--|----------------------------------|--|
| Hardware Specifications | | | | |
| Copper Ports | 24 10/100/1000BASE-T RJ45 auto-MDI/MDI-X ports | | | |
| SFP+ Slots | 4 10GBASE-SR/LR SFP+ interfaces (Port-25 to Port-28) Compatible with 1000BASE-SX/LX/BX SFP transceiver | | | |
| Console | 1 x RS232-to-RJ45 serial port (115200, 8, N, 1) | | | |
| Switch Architecture | Store-and-Forward | | | |
| Switch Fabric | 128Gbps/non-blocking | | | |
| Throughput | 95.23Mpps@64Bytes | | | |
| Address Table | 16K entries, automatic source address learning and aging | | | |
| Shared Data Buffer | 32M bits | | | |
| Flow Control | IEEE 802.3x pause frame for full-duplex Back pressure for half-duplex | | | |
| Jumbo Frame | 10K bytes | | | |
| Reset Button | < 5 sec: System reboot > 5 sec: Factory default | | | |
| Dimensions (W x D x H) | 440 x 300 x 56 mm, 1.25U height | | | |
| Weight | 4635g | 4675g | 5339g | 5439g |
| Power Consumption | Max. 488 watts/1665.13 BTU | AC: Max. 488 watts/ 1665.13 BTU DC: Max. 36.6 watts/ 124.88 BTU | Max. 723 watts/2466.98 BTU | AC: Max. 723 watts/ 2466.98 BTU DC: Max. 36.6 watts/ 124.88 BTU |
| Power Requirements – AC | AC 100~240V, 50/60Hz, 7A | AC 100~240V, 50/60Hz, 7A | AC 100~240V, 50/60Hz, 7A | AC 100~240V, 50/60Hz, 7A |
| Power Requirements – DC | -- | DC 36~60V, 2A | -- | DC 36~60V, 2A |
| ESD Protection | 6KV DC | | | |
| Fan | 3 smart fan | | | |
| LED | System: SYS (Green) AC/PWR (Green) DC (Green) (GS-5220-24UP(L)4XVR Only) Fan1/2/3 Alert (Red) PoE PWR Alert (Red) PoE Ethernet Interfaces (Port-1 to Port-24): bt PoE (Green) , af/at PoE (Orange) Ethernet Interfaces (Port-1 to Port-24): 1000 LNK/ACT (Green), 10/100 LNK/ACT (Orange) 1/10G SFP+ Interfaces (Port-25 to Port-28): 1G (Green), 10G (Orange) | | | |
| Power over Ethernet | | | | |
| PoE Standard | IEEE 802.3af/802.3at/802.3bt Ultra PoE PSE | | | |
| PoE Power Supply Type | End-span/Mid-span/UPoE | | | |
| PoE Power Output | Per port 54V DC, 75 watts (max.) | | Per port 52V DC, 75 watts (max.) | |
| Power Pin Assignment | End-span: 1/2(-), 3/6(+) Mid-span: 4/5(+), 7/8(-) UPoE: 1/2(-), 3/6(+), 4/5(+), 7/8(-) | | | |
| PoE Power Budget | 400 watts (max.) | | 600 watts (max.) | |
| PoE Ability PD @ 15 watts | 24 units | | 24 units | |
| PoE Ability PD @ 30 watts | 13 units | | 20 units | |
| PoE Ability PD @ 60 watts | 6 units | | 10 units | |
| Layer 2 Management Functions | | | | |
| Port Configuration | Port disable/enable Auto-negotiation 10/100/1000Mbps full and half duplex mode selection Flow control disable/enable | | | |
| Port Status | Display each port's speed duplex mode, link status, flow control status, auto-negotiation status, trunk status | | | |
| Port Mirroring | TX/RX/Both Many-to-1 monitor | | | |
| VLAN | 802.1Q tagged based VLAN Q-in-Q tunneling Private VLAN Edge (PVE) MAC-based VLAN Protocol-based VLAN Voice VLAN MVR (Multicast VLAN registration) Up to 255 VLAN groups, out of 4095 VLAN IDs | | | |

| | | |
|------------------------------|---|--|
| Link Aggregation | IEEE 802.3ad LACP/static trunk 14 groups with 4 port per trunk | |
| Spanning Tree Protocol | IEEE 802.1D Spanning Tree Protocol (STP) IEEE 802.1w Rapid Spanning Tree Protocol (RSTP) IEEE 802.1s Multiple Spanning Tree Protocol (MSTP) | |
| QoS | Traffic classification based, strict priority and WRR 8-level priority for switching: - Port number - 802.1p priority - 802.1Q VLAN tag - DSCP/ToS field in IP packet | |
| IGMP Snooping | IGMP (v1/v2/v3) snooping, up to 255 multicast groups IGMP querier mode support | |
| MLD Snooping | MLD (v1/v2) snooping, up to 255 multicast groups MLD querier mode support | |
| Access Control List | IP-based ACL/MAC-based ACL Up to 256 entries | |
| Bandwidth Control | Per port bandwidth control Ingress: 100Kbps~1000Mbps Egress: 100Kbps~1000Mbps | |
| Layer 3 Functions | | |
| IP Interfaces | Max. 8 VLAN interfaces | |
| Routing Table | Max. 32 routing entries | |
| Routing Protocols | IPv4 software static routing IPv6 software static routing | |
| Management | | |
| Basic Management Interfaces | Console; Telnet; Web browser; SNMP v1, v2c; 2.4-inch color LCD touch screen | |
| Secure Management Interfaces | SSH, SSL, SNMP v3 | |
| SNMP MIBs | RFC 1213 MIB-II RFC 1493 Bridge MIB RFC 1643 Ethernet MIB RFC 2863 Interface MIB RFC 2665 Ether-Like MIB RFC 2819 RMON MIB (Groups 1, 2, 3 and 9) RFC 2737 Entity MIB | RFC 2618 RADIUS Client MIB RFC 2863 IF-MIB RFC 2933 IGMP-STD-MIB RFC 3411 SNMP-Frameworks-MIB RFC 4292 IP Forward MIB RFC 4293 IP MIB RFC 4836 MAU-MIB IEEE 802.1X PAE LLDP |
| Standards Conformance | | |
| Regulatory Compliance | FCC Part 15 Class A, CE | |
| Standards Compliance | IEEE 802.3 10BASE-T IEEE 802.3u 100BASE-TX/100BASE-FX IEEE 802.3z Gigabit SX/LX IEEE 802.3ab Gigabit 1000T IEEE 802.3ae 10Gb/s Ethernet IEEE 802.3x flow control and back pressure IEEE 802.3ad port trunk with LACP IEEE 802.1D Spanning Tree Protocol IEEE 802.1w Rapid Spanning Tree Protocol IEEE 802.1s Multiple Spanning Tree Protocol IEEE 802.1p Class of Service | IEEE 802.1Q VLAN tagging IEEE 802.1x Port Authentication Network Control IEEE 802.1ab LLDP IEEE 802.3af Power over Ethernet IEEE 802.3at Power over Ethernet Plus IEEE 802.3bt 4-pair Power over Ethernet RFC 768 UDP RFC 793 TFTP RFC 791 IP RFC 792 ICMP RFC 2068 HTTP RFC 1112 IGMP v1 RFC 2236 IGMP v2 RFC 3376 IGMP v3 RFC 2710 MLD v1 RFC 3810 MLD v2 |
| Environment | | |
| Operating | Temperature: 0 ~ 50 degrees C Relative Humidity: 5 ~ 95% (non-condensing) | |
| Storage | Temperature: -10 ~ 70 degrees C Relative Humidity: 5 ~ 95% (non-condensing) | |

Drawing

- GS-5220-24UP(L)4XV

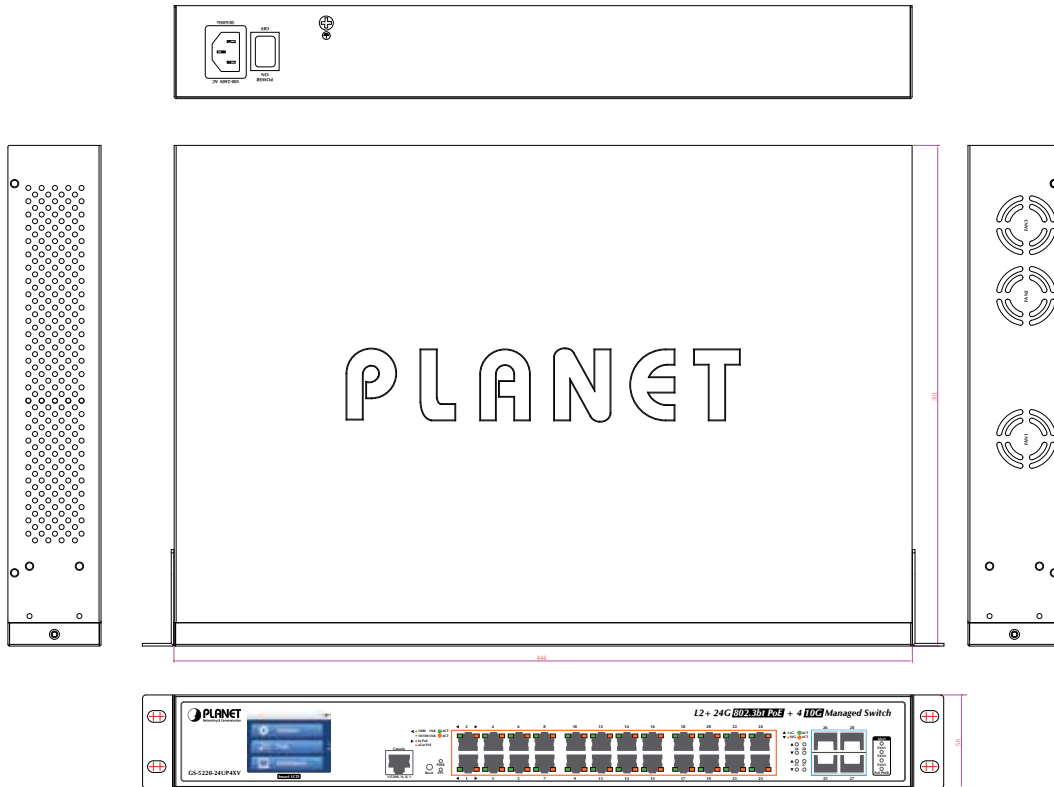

- GS-5220-24UP(L)4XVR

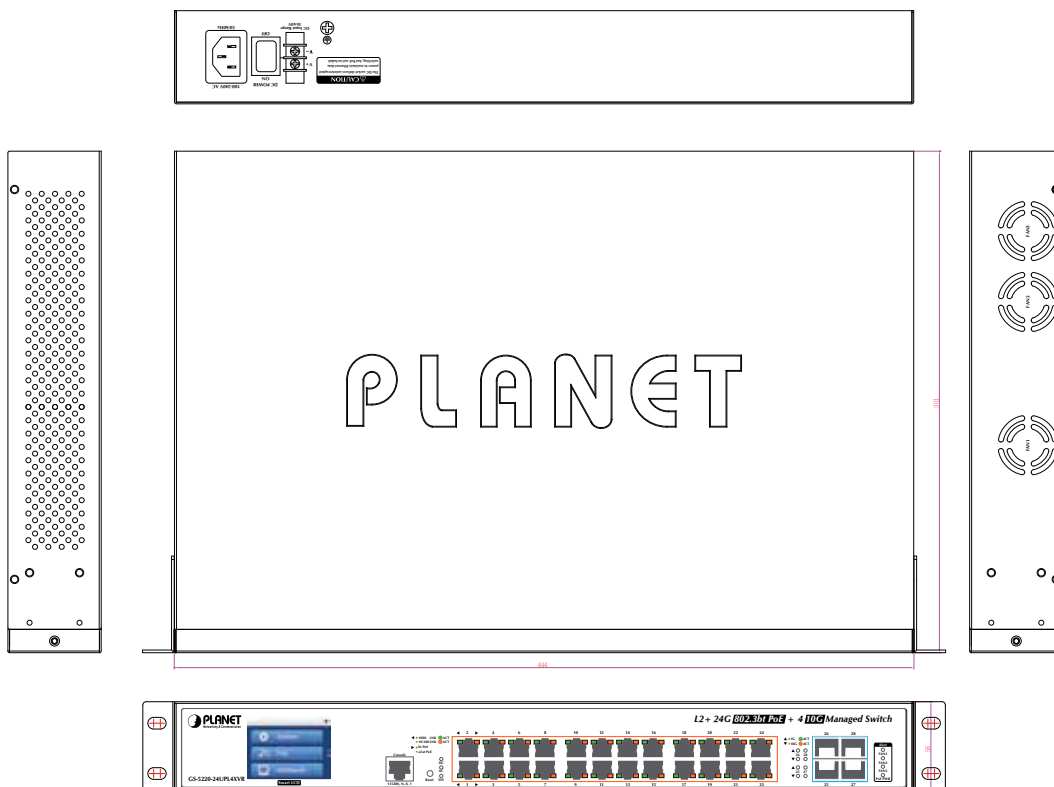

Ordering Information

| | |
|-------------------|--|
| GS-5220-24UP4XV | L2+ 24-Port 10/100/1000T Ultra PoE + 4-Port 10G SFP+ Managed Switch with LCD Touch Screen (400W) |
| GS-5220-24UP4XVR | L2+ 24-Port 10/100/1000T Ultra PoE + 4-Port 10G SFP+ Managed Switch with LCD Touch Screen and Redundant Power (400W) |
| GS-5220-24UPL4XV | L2+ 24-Port 10/100/1000T Ultra PoE + 4-Port 10G SFP+ Managed Switch with LCD Touch Screen (600W) |
| GS-5220-24UPL4XVR | L2+ 24-Port 10/100/1000T Ultra PoE + 4-Port 10G SFP+ Managed Switch with LCD Touch Screen and Redundant Power (600W) |

Available 10Gbps Modules

| | |
|---------------|--|
| CB-DASFP-0.5M | 10G SFP+ Directly-attached Copper Cable (0.5m in length) |
| CB-DASFP-2M | 10G SFP+ Directly-attached Copper Cable (2m in length) |
| MTB-SR | 10GBASE-SR mini-GBIC module - 300m |
| MTB-LR | 10GBASE-LR mini-GBIC module - 10km |
| MTB-LA20 | 10GBASE-LX (WDM,TX:1270nm) mini-GBIC module - 20km |
| MTB-LB20 | 10GBASE-LX (WDM,TX:1330nm) mini-GBIC module - 20km |
| MTB-LA40 | 10GBASE-LX (WDM,TX:1270nm) mini-GBIC module - 40km |
| MTB-LB40 | 10GBASE-LX (WDM,TX:1330nm) mini-GBIC module - 40km |
| MTB-LA60 | 10GBASE-LX (WDM,TX:1270nm) mini-GBIC module - 60km |
| MTB-LB60 | 10GBASE-LX (WDM,TX:1330nm) mini-GBIC module - 60km |

Available 1000Mbps Modules

| | |
|----------|--|
| MGB-GT | SFP-Port 1000BASE-T Module |
| MGB-SX | SFP-Port 1000BASE-SX mini-GBIC module - 220/550m |
| MGB-LX | SFP-Port 1000BASE-LX mini-GBIC module - 10km |
| MGB-L30 | SFP-Port 1000BASE-LX mini-GBIC module - 30km |
| MGB-L50 | SFP-Port 1000BASE-LX mini-GBIC module - 50km |
| MGB-L70 | SFP-Port 1000BASE-LX mini-GBIC module - 70km |
| MGB-L120 | SFP-Port 1000BASE-LX mini-GBIC module - 120km |
| MGB-LA10 | SFP-Port 1000BASE-LX (WDM,TX:1310nm) mini-GBIC module - 10km |
| MGB-LB10 | SFP-Port 1000BASE-LX (WDM,TX:1550nm) mini-GBIC module - 10km |
| MGB-LA20 | SFP-Port 1000BASE-LX (WDM,TX:1310nm) mini-GBIC module - 20km |
| MGB-LB20 | SFP-Port 1000BASE-LX (WDM,TX:1550nm) mini-GBIC module - 20km |
| MGB-LA40 | SFP-Port 1000BASE-LX (WDM,TX:1310nm) mini-GBIC module - 40km |
| MGB-LB40 | SFP-Port 1000BASE-LX (WDM,TX:1550nm) mini-GBIC module - 40km |