

**8-Port 10/100TX Fast Ethernet Switch with
4-Port 802.3at PoE+ Injector**

FSD-804P

User's Manual

Trademarks

Copyright © PLANET Technology Corp. 2016.

Contents are subject to revision without prior notice.

PLANET is a registered trademark of PLANET Technology Corp. All other trademarks belong to their respective owners.

Disclaimer

PLANET Technology does not warrant that the hardware will work properly in all environments and applications, and makes no warranty and representation, either implied or expressed, with respect to the quality, performance, merchantability, or fitness for a particular purpose. PLANET has made every effort to ensure that this User's Manual is accurate; PLANET disclaims liability for any inaccuracies or omissions that may have occurred.

Information in this User's Manual is subject to change without notice and does not represent a commitment on the part of PLANET. PLANET assumes no responsibility for any inaccuracies that may be contained in this User's Manual. PLANET makes no commitment to update or keep current the information in this User's Manual, and reserves the right to make improvements to this User's Manual and/or to the products described in this User's Manual, at any time without notice.

If you find information in this manual that is incorrect, misleading, or incomplete, we would appreciate your comments and suggestions.

FCC Warning

This equipment has been tested and found to comply with the limits for a Class A digital device, pursuant to Part 15 of the FCC Rules. These limits are designed to provide reasonable protection against harmful interference when the equipment is operated in a commercial environment. This equipment generates, uses, and can radiate radio frequency energy and, if not installed and used in accordance with the Instruction manual, may cause harmful interference to radio communications. Operation of this equipment in a residential area is likely to cause harmful interference in which case the user will be required to correct the interference at his own expense.

CE Mark Warning

This is a Class A product. In a domestic environment, this product may cause radio interference, in which case the user may be required to take adequate measures.

Energy Saving Note of the Device

This power required device does not support Standby mode operation. For energy saving, please remove the power cable to disconnect the device from the power circuit. In view of saving the energy and reducing the unnecessary power consumption, it is strongly suggested to remove the power connection for the device if this device is not intended to be active.

WEEE Warning



To avoid the potential effects on the environment and human health as a result of the presence of hazardous substances in electrical and electronic equipment, end users of electrical and electronic equipment should understand the meaning of the crossed-out wheeled bin symbol. Do not dispose of WEEE as unsorted municipal waste and have to collect such WEEE separately.

Revision

PLANET 8-Port 10/100TX Fast Ethernet Switch with 4-Port 802.3at PoE+ Injector
User's Manual

FOR MODEL: FSD-804P

REVISION: 4.0 (November 2016)

Part No.: 2351-A31110-000





Table of Contents

1. Introduction	5
1.1 Checklist.....	5
1.2 Product Description.....	5
1.3 Features	6
1.4 Specifications	7
2. Hardware Description	9
2.1 Front Panel	9
2.1.1 LED Indicators	10
2.2 Rear Panel	11
3. Hardware Installation	12
3.1 Desktop Installation	13
3.2 Rack Mounting	14
3.3 Wall Mounting Installation	15
3.4 Product Application	16
3.4.1 Connecting end node or Switch	16
3.4.2 Department/Workgroup PoE+ Switch	17
3.5 Power over Ethernet Powered Device	18
4. Power over Ethernet Overview	19
5. Troubleshooting	22
Appendix A Networking Connection	23
A.1 10/100Mbps, 10/100BASE-TX	23

1. Introduction

1.1 Checklist

Check the contents of your package for the following parts:

FSD-804P x 1		User's Manual x 1
		
Power Cord x 1	Rubber Feet x 4	Two Rack-mounting Brackets with Attachment Screws x 1
		

If any of these pieces are missing or damaged, please contact your dealer immediately; if possible, retain the carton including the original packing material, and use them again to repack the product in case there is a need to return it to us for repair.

1.2 Product Description

To fulfill the demand of sufficient PoE power for network applications, the FSD-804P 8-Port 10/100TX Fast Ethernet Switch with 4-Port 802.3at PoE+ Injector, a new member of the 802.3at PoE Fast Ethernet Switch family, features high-performance IEEE 802.3at PoE (up to 30 watts) and totally a 60-watt PoE budget on half of the switch's eight 10/100Mbps TP ports. The four 802.3at PoE+ ports provide PoE power injector function which is able to drive 2 IEEE 802.3at or 4 IEEE 802.3af compliant powered devices. The FSD-804P also provides a simple, cost-effective, and non-blocking wire-speed performance with 8.5-inch metal housing suitable for desktop deployment for SOHO and department network applications.

All RJ45 copper interfaces in the FSD-804P support 10/100Mbps auto-negotiation for optimal speed detection through RJ45 Category 6, 5 or 5e cables. It also supports standard auto-MDI/MDI-X that can detect the type of connection to any Ethernet device without requiring special straight-through or crossover cables.

1.3 Features

- Physical Port
 - 8-port 10/100BASE-TX Fast Ethernet RJ45 copper
 - 4-port IEEE 802.3at/af PoE Injector (Port-1 to Port-4)
- Power over Ethernet
 - Complies with IEEE 802.3af/at Power over Ethernet end-span PSE
 - Up to 4 ports of IEEE 802.3af/802.3at devices powered
 - Supports PoE Power up to 30.8 watts for each PoE port
 - Each port supports 53V DC power to PoE powered device
 - 60-watt PoE budget
 - Auto detects powered device (PD)
 - Circuit protection prevents power interference between ports
 - Remote power feeding up to 100m with standard mode, 200m with extended mode
- Switching
 - Hardware based 10/100Mbps auto-negotiation and auto MDI/MDI-X
 - Flow control for full duplex operation and back pressure for half duplex operation
 - IEEE 802.1Q VLAN transparency
 - Hardware DIP switch for **“Standard”** and **“Extend”** mode selection; the **“Extend”** mode features 30-watt PoE transmit distance of 200m at speed of 10Mbps (Only for Port1 – Port4)
- Hardware
 - 8.5-inch desktop size, 1U height, rack mountable
 - LED indicators for system power, per port PoE ready and PoE activity, speed, Link/Act
 - Fanless design
 - Supports Energy-Efficient Ethernet (EEE) function (IEEE 802.3az)

1.4 Specifications

Model	FSD-804P
Hardware Specifications	
Hardware Version	4
10/100BASE-TX MDI/MDIX Ports	8
PoE Injector Port	4 ports with 802.3at/af PoE injector function with Port-1 to Port-4
Switch Architecture	Store-and-Forward
Switch Fabric	1.6Gbps/non-blocking
Switch Throughput@64 bytes	1.19Mpps@64 bytes
MAC Address Table	1K entries, automatic source address learning and aging
Flow Control	IEEE 802.3x pause frame for full-duplex Back pressure for half-duplex
LED	System: Power (Green) PoE max. (Green) 10/100BASE-TX RJ45 Interfaces: 10/100Mbps LNK/ACT (Green) PoE interfaces: PoE-in-Use (Orange)
DIP Switch	Selectable operation mode ● Standard ● Extended
Dimensions (W x D x H)	215 x 133 x 42 mm (1U height)
Enclosure	Metal
Weight	880g
Power Requirements	AC 100~240V, 50/60Hz, 2A max.
Power Consumption/Dissipation	Max. 65 watts/223 BTU
Thermal Fan	Fanless
Power over Ethernet	
PoE Standard	IEEE 802.3af Power over Ethernet/PSE IEEE 802.3at Power over Ethernet Plus/PSE
PoE Power Supply Type	End-span
PoE Power Output	Per port 53V DC, 600mA. max. 30 watts

Power Pin Assignment	1/2(+), 3/6(-)
PoE Power Budget	60 watts
Max. Number of Class 2 PDs	4
Max. Number of Class 3 PDs	4
Max. Number of Class 4 PDs	2
Standards Conformance	
Regulatory Compliance	FCC Part 15 Class A, CE
Standards Compliance	IEEE 802.3 10BASE-T IEEE 802.3u 100BASE-TX IEEE 802.3x Flow control and back pressure IEEE 802.3af Power over Ethernet IEEE 802.3at Power over Ethernet Plus IEEE 802.3az Energy Efficient Ethernet (EEE)
Environment	
Operating	Temperature: 0 ~ 50 degrees C Relative Humidity: 5 ~ 95% (non-condensing)
Storage	Temperature: -10 ~ 70 degrees C Relative Humidity: 5 ~ 95% (non-condensing)

2. Hardware Description

These switches provide two different running speeds – 10Mbps and 100Mbps, and automatically distinguish the speed of the incoming connection.

This section describes the hardware features of the FSD-804P. For easier management and control of the FSD-804P, familiarize yourself with its display indicators and ports. Front panel illustrations in this chapter display the unit LED indicators. Before connecting any network device to the FSD-804P, please read this chapter carefully.

2.1 Front Panel

The Front Panel of the FSD-804P PoE+ Ethernet Switch consists of 8x Auto-Sensing 10/100Mbps Ethernet RJ45 Ports. The LED Indicators are also located on the front panel of the FSD-804P.

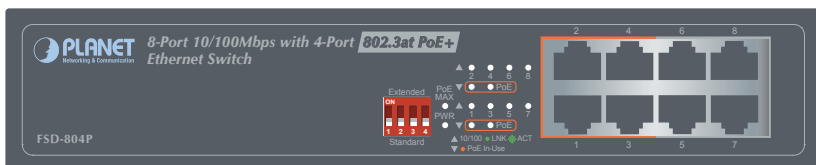
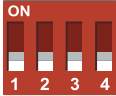
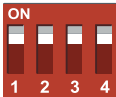
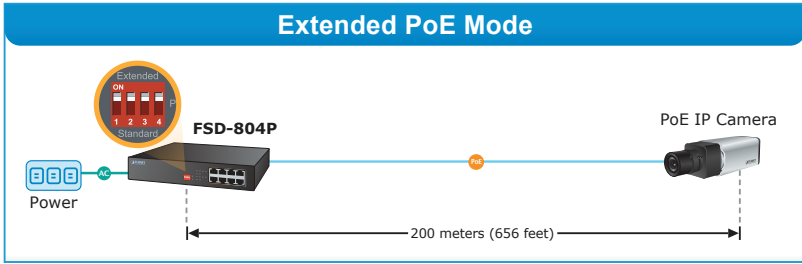
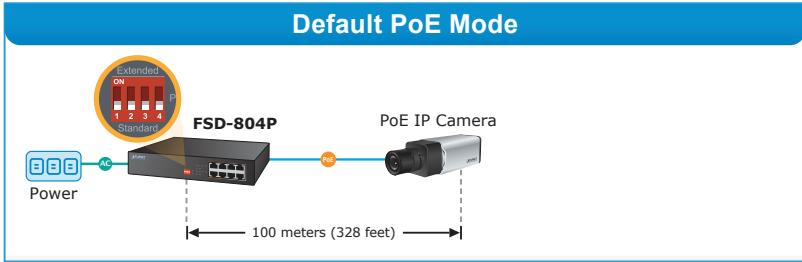

Figure 2-1: FSD-804P Switch Front Panel

The front panel of FSD-804P provides one DIP switch for “**Standard**” and “**Extended**” mode selections. The detailed descriptions are shown in the following table.

DIP Switch Mode	Function
<p>Standard</p>  <p>(default)</p>	<p>This mode makes the FSD-804P operate as a general switch and all ports operate at 10/100Mbps auto-negotiation.</p>
<p>Extended</p> 	<p>This mode also makes the FSD-804P operate at auto-negotiation 10Mbps speed duplex mode only, but the delivery distance of PoE power and network data can reach 200m.</p>



- 10BASE-T UTP with PoE
- 100BASE-TX UTP with PoE
- Power Line (AC)

2.1.1 LED Indicators

System

LED	Color	Function
PWR	Green	Lights to indicate that the Switch has power.
POE MAX	Green	Lights to indicate that the PoE usage is full.

Per 10/100Mbps Port

LED	Color	Function
PoE-in-use	Orange	Lights to indicate the port is providing 53V DC in-line power. (1-4 ports)
Speed/ LNK/ACT	Green	Lights to indicate the Switch is successfully connecting to the network at 10/100Mbps. Blinks to indicate that the Switch is actively sending or receiving data over that port.

2.2 Rear Panel

The rear panel of the FSD-804P has an AC inlet power socket, which accepts input power from 100 to 240V AC, 50-60Hz.

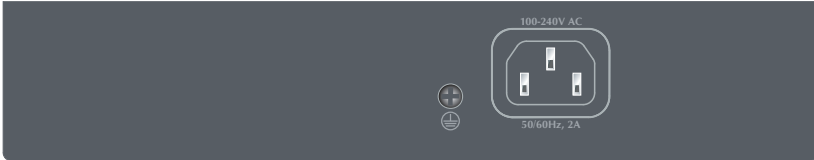

Figure 2-2: FSD-804P Switch Rear Panel



Power Note

1. The device is a power-required device which means it will not work till it is powered. If your networks should be active all the time, please consider using UPS (Uninterrupted Power Supply) for your device. It will prevent you from network data loss or network downtime.
2. In some areas, installing a surge suppression device may also help to protect your FSD-804P from being damaged by unregulated surge or current to the FSD-804P.

3. Hardware Installation

Start up

Please refer to the following for your cabling:

10/100BASE-TX

All 10/100BASE-TX ports come with Auto-Negotiation capability. They automatically support 100BASE-TX and 10BASE-T networks. Users only need to plug a working network device into one of the 10/100BASE-TX ports, and then turn on the FSD-804P. The port will automatically run in 10Mbps, 20Mbps and 100Mbps or 200Mbps after the negotiation with the connected device.

Cabling

Each of the 10/100BASE-TX port uses RJ45 sockets -- similar to the phone jacks -- for connection of unshielded twisted-pair cable (UTP). The IEEE 802.3/802.3u Fast Ethernet standard requires Category 5 UTP for 100Mbps 100BASE-TX. 10/100BASE-TX networks can use Cat.3, 4, 5, 5e or 6 UTP (see table below). Maximum distance is 100 meters (328 feet).

Port Type	Cable Type	Connector
10BASE-T	Cat.3, 4, 5, 2-pair	RJ45
100BASE-TX	Cat.5, 5e, 6 UTP, 4-pair	RJ45

Any Ethernet devices like hubs/PCs can be connected to the FSD-804P by using straight-through wires. The whole 10/100Mbps ports are auto-MDI/MDI-X that can be used on straight-through or crossover cable.

3.1 Desktop Installation

To install the FSD-804P on desktop, simply follow the following steps:

Step 1: Attach the rubber feet to the recessed areas on the bottom of the FSD-804P, as shown in Figure 3-1.

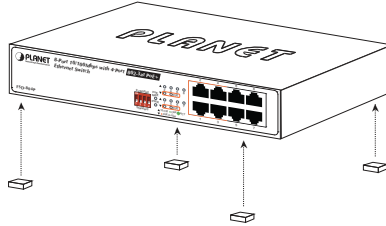

Figure 3-1: Attaching the Rubber Feet to the FSD-804P

Step 2: Place the FSD-804P on desktop near an AC power source.

Step 3: Keep enough ventilation space between the FSD-804P and the surrounding objects.



Note

When choosing a location, please keep in mind the environmental restrictions discussed in Chapter 1, Section 4, under Specifications.

Step 4: Connect your FSD-804P to 802.3af/802.3at complied power devices (PDs) and other network devices.

- A.** Connect one end of a standard network cable to the 10/100BASE-TX RJ45 ports on the front panel of the FSD-804P.
- B.** Connect the other end of the cable to the network devices such as printer servers, workstations, routers, etc.



Note

Connection to the Switch requires UTP Category 5, 5e, 6 network cabling with RJ45 tips. For more information, please see the Cabling Specification in Appendix A.

Step 5: Supply power to the FSD-804P.

- A.** Connect one end of the power cable to the FSD-804P.
- B.** Connect the power plug of the power cable to a standard wall outlet.

When the FSD-804P receives power, the Power LED should remain solid Green.

3.2 Rack Mounting

To install the FSD-804P in a 19-inch standard rack, follow the instructions described below.

Step 1: Place your FSD-804P on a hard flat surface, with the front panel positioned towards your front side.

Step 2: Attach a rack-mount bracket to each side of the FSD-804P with supplied screws attached to the package. Figure 3-2 shows how to attach brackets to one side of the FSD-804P.

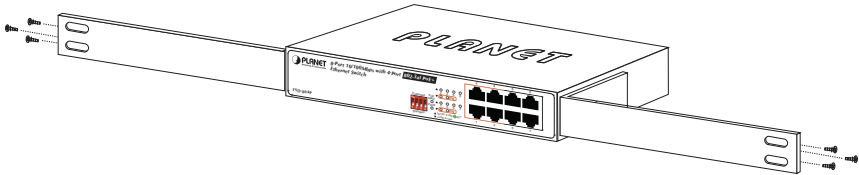

Figure 3-2: Attaching the Brackets to the FSD-804P.



You must use the screws supplied with the mounting brackets. Damage caused to the parts by using incorrect screws would invalidate the warranty.

Step 3: Secure the brackets tightly.

Step 4: Follow the same steps to attach the second bracket to the opposite side.

Step 5: After the brackets are attached to the FSD-804P, use suitable screws to securely attach the brackets to the rack, as shown in Figure 3-3.

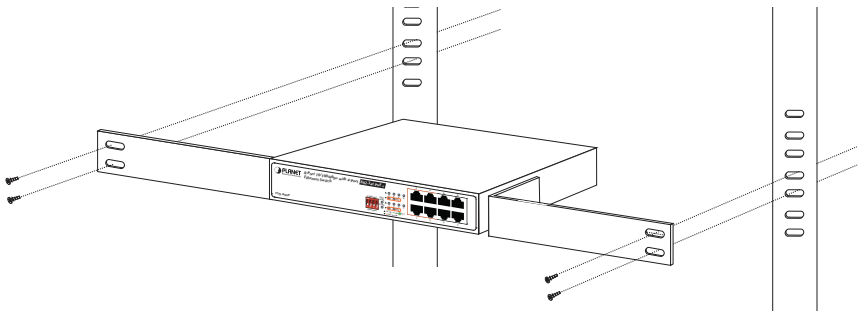

Figure 3-3: Mounting the FSD-804P in a Rack

Step 6: Proceed with Steps 4 and 5 of **session 3.1 Desktop Installation** to connect the network cabling and supply power to your Switch.

3.3 Wall Mounting Installation

Step 1: Please find the wall that can mount the FSD-804P.

Step 2: Install two screws on the wall.

Step 3: Hang the FSD-804P on the screws from the wall.

Step 4: Repeat step 5 of Desktop Installation for power supply to the FSD-804P.



Note

Before mounting the device to the wall, please check the location of the electrical outlet and the length of the Ethernet cable.

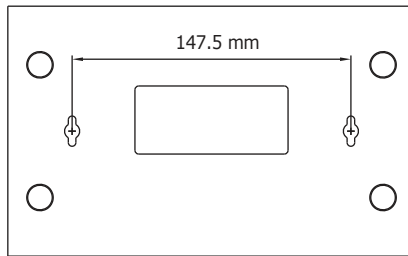

FSD-804P Switch Bottom Side

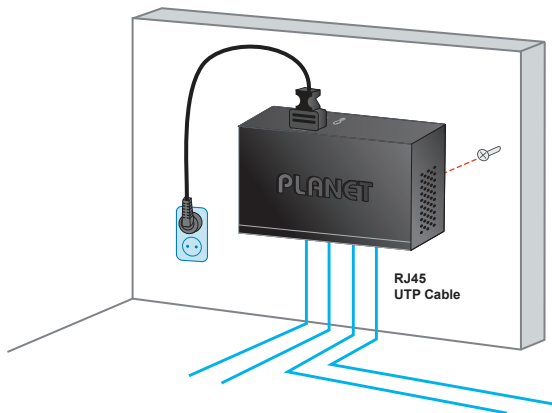

3.4 Product Application

3.4.1 Connecting end node or Switch

1. Place the FSD-804P on a smooth surface or fasten the mounting brackets purchased separately with the provided screws in a standard 19" rack.
2. Connect the power cord to the power inlet socket of the FSD-804P and the other end into the local power source outlet. When the Switch receives power, the Power LED should remain solid Green.
3. Connect the other switch or PC to one port of the FSD-804P using Category 3/4/5/5e/6 UTP/STP cabling.
4. Connect another switch or PC to the other port of FSD-804P by following the same process as described in Step 3.

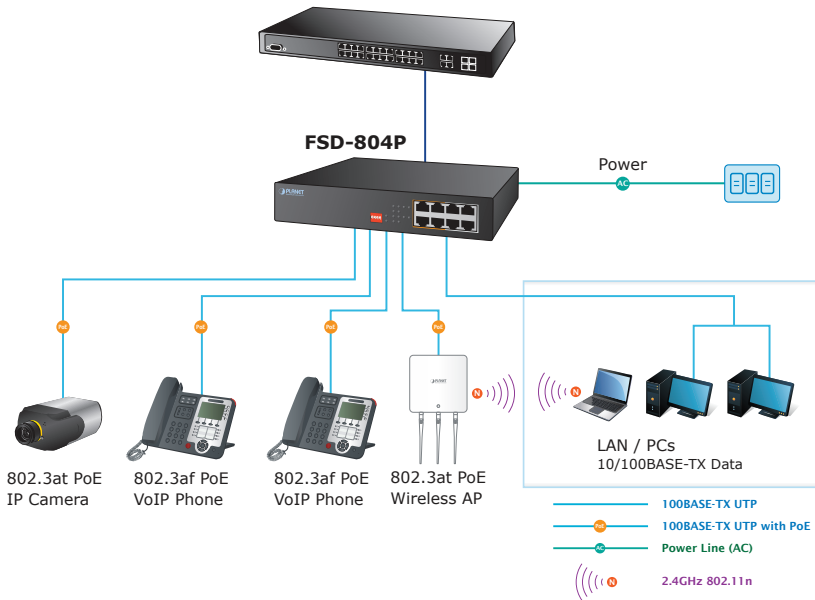

Figure 3-4: End node or Switch Connection



Cable distance for Switch

The cable distance between the FSD-804P and PC should not exceed 100 meter for UTP/STP cable.

Make sure the wiring is correct

Category 3/4/5 cable can be used in 10Mbps operation. To reliably operate your network at 100Mbps, you must use an Unshielded Twisted-Pair (UTP) Category 5/5e/6 cable, or better Data Grade cabling. While Category 3 or 4 cables may initially seem to work, it will soon cause data loss.

3.4.2 Department/Workgroup PoE+ Switch

With 4 PoE+ in-line power interfaces, the FSD-804P can easily build a power that can be centrally controlled by IP phone system, IP camera system and wireless AP group for the enterprise. For instance, up to 4 cameras can be installed around the corner in the company for surveillance demands or up to 4 wireless APs can be utilized to build a wireless roaming environment in the office. Without the power-socket limitation, the Switch makes the installation of cameras or wireless AP more easily and efficiently

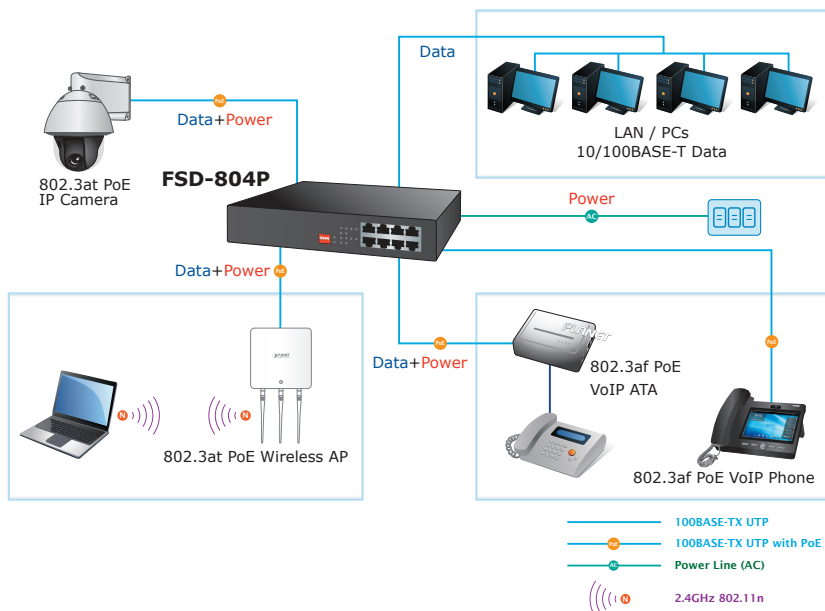

Figure 3-5: Department/Workgroup PoE/PoE+ Switch Connection

3.5 Power over Ethernet Powered Device



3~5 Watts

Voice over IP Phones

Enterprise can install PoE VoIP Phone, ATA and other Ethernet/non-Ethernet end-devices in the central area where UPS is installed for uninterruptible power system and power control system.



6~12 Watts

Wireless LAN Access Points

Museums, airports, hotels, scenic places, campuses, factories, and warehouses can install access points anywhere with no hesitation.



8~25 Watts

IP Surveillance

Enterprises, museums, campuses, hospitals and banks can install IP cameras without the limit to install location as electricians are not needed to install AC sockets.



3~12 Watts

PoE Splitter

PoE Splitter is used to split the PoE 52V DC over the Ethernet cable into 5/12V DC power output.

It frees the device deployment from restrictions due to power outlet locations, which eliminate the costs for additional AC wiring and reduces the installation time.

4. Power over Ethernet Overview

What is PoE?

PoE is an abbreviation of Power over Ethernet. The PoE technology means a system safely transmits both power and data on Ethernet UTP cable. The IEEE standard for PoE technology requires Category 5 cable or higher for high power PoE levels, but can operate with Cat3 cable for low power levels. Power is supplied in common mode over two or more of the differential pairs of wires found in the Ethernet cables and comes from a power supply within a PoE-enabled network device such as an Ethernet switch or can be injected into a cable run with a mid-span power supply.

The original IEEE 802.3af-2003 PoE standard provides up to 15.4W of DC power (minimum 44V DC and 350mA) to each device. Only 12.95W is assured to be available at the powered device as some power is dissipated in the cable.

The updated IEEE 802.3at-2009 PoE standard, also known as PoE+ or PoE plus, provides up to 25.5W of power. The 2009 standard prohibits a powered device from using all four pairs for power. The 802.3af/802.3at defines two types of source equipment: mid-span and end-span.

Mid-span

Mid-span device is placed between legacy switch and the powered device. Mid-span taps the unused wire pairs 4/5 and 7/8 to carry power; the other four are for data transmission.

End-span

End-span device is directly connected with power device. End-span could also tap the wire 1/2 and 3/6.

PoE System Architecture

The specification of PoE typically requires two devices: the **Powered Source Equipment (PSE)** and the Powered Device (PD). The PSE is either an end-span or a mid-span, while the PD is a PoE-enabled terminal, such as IP phones, wireless LAN, etc. Power can be delivered over data pairs or spare pairs of standard Cat5 cabling.

Powered Source Equipment (PSE)

Power sourcing equipment (PSE) is a device such as a switch that provides (sources) power on the Ethernet cable. The maximum allowed for continuous output power per cable in IEEE 802.3af is 15.4W. A later specification, IEEE 802.3at, offers 25.50W. When the device is a switch, it is commonly called an end-span (although IEEE 802.3af refers to it as endpoint). Otherwise, if it is an intermediary device between a non PoE capable switch and a PoE device, it is called a mid-span. An external PoE injector is a mid-span device.

Powered Device

A powered device (PD) is a device powered by a PSE and thus consumes energy. Examples include wireless access points, IP phones, and IP cameras. Many PDs have an auxiliary power connector for an optional, external power supply. Depending on the PD design, some, none, or all power can be supplied from the auxiliary port, with the auxiliary port sometimes acting as backup power in case of PoE supplied power failure.

How Power is Transferred through Cable

A standard Cat5 Ethernet cable has four twisted pairs, but only two of these are used for 10BASE-T and 100BASE-TX. The specification allows two options for using these cables for power, shown in Figure 1 and Figure 2:

The spare pairs are used. Figure 1 shows the pair on pins 4 and 5 connected together and forming the positive supply, and the pair on pins 7 and 8 connected together and forming the negative supply. (In fact, a late change to the spec allows either polarity to be used).

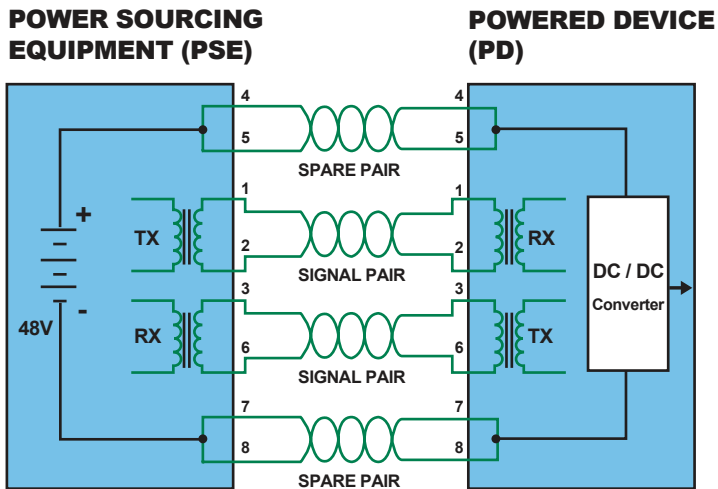

Figure 1: Power Supplied over Spare Pins

The data pairs are used. Since Ethernet pairs are transformers coupled at each end, it is possible to apply DC power to the center tap of the isolated transformer without upsetting the data transfer. In this mode of operation, the pair on pins 3 and 6 and the pair on pins 1 and 2 can be of either polarity.

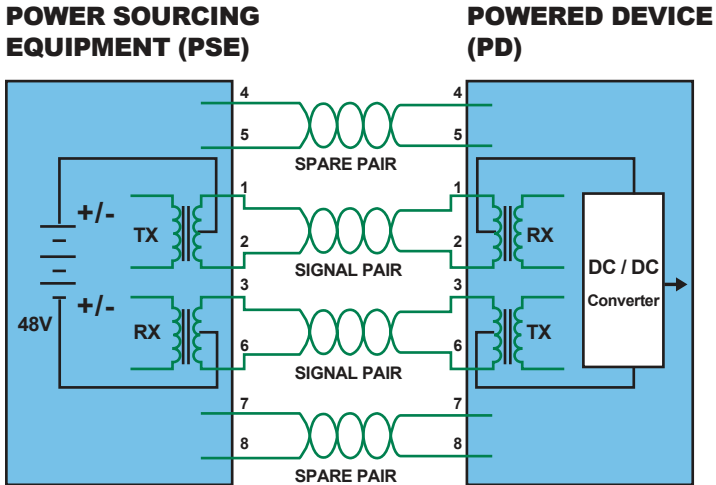

Figure 2: Power Supplied over the Data Pins

When to install PoE

Consider the following scenarios:

- You're planning to install the latest VoIP phone system to minimize cabling building costs when your company moves into a new office next month.
- The company staff has been clamoring for a wireless access point in the picnic area behind the building so they can work on their laptops through lunch, but the cost of electrical power to the outside is not affordable.
- Management asks for IP Surveillance Cameras and business access systems throughout the facility, but they would rather avoid another electrician's payment.

5. Troubleshooting

This chapter contains information to help you solve issues. If the FSD-804P is not functioning properly, make sure the FSD-804P was set up according to instructions in this manual.

The Link LED is not lit.

Solution:

Check the cable connection and also try to swap one new cable.

100BASE-TX port link LED is lit, but the traffic is irregular.

Solution:

Make sure the attached device is not set to full duplex. Some devices use a physical or software switch to change duplex modes. Auto-negotiation may not recognize this type of full-duplex setting.

Why the Switch isn't connected to the network

Solution:

Check the LNK/ACT LED on the FSD-804P. Try another port on the FSD-804P. Make sure the cable is installed properly. Make sure the cable is the right type. Turn off the power. After a while, turn on the power again.

Why the FSD-804P, connected to PoE device, cannot be powered on

Solution:

1. Please check the cable type of the connection from the FSD-804P to the other end. The cable should be an 8-wire UTP, Category 5 or above and EIA568 cable within 100 meters. A cable with only 4-wire, short loop or over 100 meters will affect the power supply.
2. Please make sure the device is fully complied with IEEE 802.3af/IEEE 802.3at standard.

What is the power output of each PoE port?

Solution:

1. Each PoE port supports **53V-54 DC, 600mA** and **a maximum of 30 watts** of power output. Detect and inject by the standard of IEEE 802.3at.
2. Each PoE port supports **53V-54 DC, 300mA** and **a maximum of 15.4 watts** of power output. Detect and inject by the standard of IEEE 802.3af.

Appendix A Networking Connection

A.1 10/100Mbps, 10/100BASE-TX

When connecting Switch to another Fast Ethernet switch, a straight-through or crossover cable might be necessary. Each port of the Switch supports auto-MDI/MDI-X detection, meaning you can directly connect the Switch to any Ethernet devices without making a crossover cable. The following table and diagram show the standard RJ45 receptacle/connector and their pin assignments:

RJ45 Connector pin assignment		
Contact	MDI Media Dependent Interface	MDI-X Media Dependent Interface-Cross
1	Tx + (transmit)	Rx + (receive)
2	Tx - (transmit)	Rx - (receive)
3	Rx + (receive)	Tx + (transmit)
4, 5	Not used	
6	Rx - (receive)	Tx - (transmit)
7, 8	Not used	

The standard cable, RJ45 pin assignment

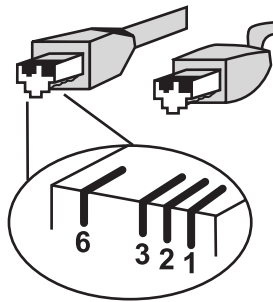

The standard RJ45 receptacle/connector

There are 8 wires on a standard UTP/STP cable and each wire is color-coded. The following shows the pin allocation and color of straight-through cable and crossover cable connection:



Figure A-1: Straight-through and Crossover Cable

Please make sure your connected cables are with the same pin assignment and color as the above description before deploying the cables into your network.