

User's Manual

H.265 3 Mega-pixel Vandalproof IR IP Camera with Remote Focus and Zoom

▶ ICA-M5380P



Copyright

Copyright © 2016 by PLANET Technology Corp. All rights reserved. No part of this publication may be reproduced, transmitted, transcribed, stored in a retrieval system, or translated into any language or computer language, in any form or by any means, electronic, mechanical, magnetic, optical, chemical, manual or otherwise, without the prior written permission of PLANET.

PLANET makes no representations or warranties, either expressed or implied, with respect to the contents hereof and specifically disclaims any warranties, merchantability or fitness for any particular purpose. Any software described in this manual is sold or licensed "as it is". Should the programs prove defective following their purchase, the buyer (and not PLANET, its distributor, or its dealer) assumes the entire cost of all necessary servicing, repair, and any incidental or consequential damages resulting from any defect in the software. Further, PLANET reserves the right to revise this publication and to make changes from time to time in the contents hereof without obligation to notify any person of such revision or changes.

All brand and product names mentioned in this manual are trademarks and/or registered trademarks of their respective holders.

Federal Communication Commission Interference Statement

This equipment has been tested and found to comply with the limits for a Class B digital device, pursuant to Part 15 of FCC Rules. These limits are designed to provide reasonable protection against harmful interference in a residential installation. This equipment generates, uses, and can radiate radio frequency energy and, if not installed and used in accordance with the instructions, may cause harmful interference to radio communications. However, there is no guarantee that interference will not occur in a particular installation. If this equipment does cause harmful interference to radio or television reception, which can be determined by turning the equipment off and on, the user is encouraged to try to correct the interference by one or more of the following measures:

1. Reorient or relocate the receiving antenna.
2. Increase the separation between the equipment and receiver.
3. Connect the equipment into an outlet on a circuit different from that to which the receiver is connected.
4. Consult the dealer or an experienced radio technician for help.

FCC Caution

To assure continued compliance, use only shielded interface cables when connecting to computer or peripheral devices. Any changes or modifications not expressly approved by the party responsible for compliance could void the user's authority to operate the equipment.

This device complies with Part 15 of the FCC Rules. Operation is subject to the following two conditions: (1) This device may not cause harmful interference, and (2) this device must accept any interference received, including interference that may cause undesired operation.

Federal Communication Commission (FCC) Radiation Exposure Statement

This equipment complies with FCC radiation exposure set forth for an uncontrolled environment. In order to avoid the possibility of exceeding the FCC radio frequency exposure limits, human proximity to the antenna shall not be less than 20 cm (8 inches) during normal operation.

Safety

This equipment is designed with the utmost care for the safety of those who install and use it. However, special attention must be paid to the dangers of electric shock and static electricity when working with electrical equipment. All guidelines of this and of the computer manufacture must therefore be allowed at all times to ensure the safe use of the equipment.

CE Mark Warning

This is a Class B product. In a domestic environment, this product may cause radio interference, in which case the user may be required to take adequate measures.

WEEE Regulation



To avoid the potential effects on the environment and human health as a result of the presence of hazardous substances in electrical and electronic equipment, end users of electrical and electronic equipment should understand the meaning of the crossed-out wheeled bin symbol. Do not dispose of WEEE as unsorted municipal waste and have to collect such WEEE separately.

Revision

User's Manual of PLANET H.265 3 Mega-pixel Vandalproof IR IP Camera with Remote Focus and Zoom

Model: ICA-M5380P

Rev: 1.00 (July, 2016)

Part No. EM-ICA-M5380P_v1.0

Table of Contents

Chapter 1. Product Introduction.....	7
1.1 Package Contents	7
1.2 Overview.....	7
1.3 Features	11
1.4 Product Specifications	12
Chapter 2. Hardware Interface	14
2.1 Physical Descriptions	14
2.1.1 Identification of ICA-M5380P Physical Details.....	14
2.1.2 Inside view	15
2.2 Hardware Installation.....	18
2.3 Initial Utility Installation	21
2.4 Preparation	24
2.4.1 Search and View by PLANET IP Wizard II.....	24
2.4.2 Configuring Network by PLANET IP Wizard II	26
2.5 Using UPnP of Windows XP or 7	28
2.5.1 Windows XP.....	28
2.5.2 Windows 7.....	32
2.6 Setup ActiveX to use the Internet Camera	34
2.6.1 Internet Explorer 6 for Windows XP.....	34
2.6.2 Internet Explorer 7 for Windows XP.....	35
2.6.3 Internet Explorer 7 for Windows Vista.....	35
Chapter 3. Web-based Management.....	37
3.1 Introduction.....	37
3.2 Connecting to Internet Camera	37
3.3 Live View	42
3.4 ActiveX Control.....	43
3.4.1 Digital Zoom	43
3.4.2 Snapshot	44
3.4.3 Record.....	44
3.4.4 Volume	45
3.4.5 About	46
3.5 Network Configuration.....	46
3.5.1 Network	46
3.5.2 IPv6	48
3.5.3 HTTPS.....	48
3.5.4 DDNS server	49
3.5.5 PPPoE.....	50

3.5.6 Streaming	51
3.5.7 UPnP	52
3.5.8 Bonjour	53
3.5.9 IP Filter	54
3.5.10 IP Notification	55
3.5.11 CoS.....	56
3.5.12 Qos.....	57
3.5.13 IEEE 802.1X.....	59
3.6 Camera Configuration	59
3.6.1 Picture	60
3.6.2 Exposure Control	63
3.6.3 Privacy Mask.....	64
3.7 Focus	65
3.8 System Configuration	66
3.8.1 System	66
3.8.2 Date & Time	67
3.8.3 Maintenance.....	68
3.9 Video Configuration	70
3.9.1 Common.....	70
3.9.2 Overlay Image.....	71
3.8.3 Video Profile	72
3.9.4 ONVIF Profile	74
3.9.5 ROI	76
3.9.6 AOI	77
3.9.7 Pixel Counter.....	78
3.10 Audio Configuration	78
3.10.1 Setting	78
3.10.2 Alarm Voice	79
3.11 User Configuration.....	80
3.12 Protocol Configuration.....	81
3.12.1 ONVIF	81
3.12.2 SNMP.....	81
3.13 E-mail Configuration.....	82
3.14 Event Detection Configuration.....	83
3.14.1 Motion Detection	84
3.14.2 Camera Tampering.....	85
3.14.3 Audio Detection	86
3.15 Storage Configuration.....	86
3.15.1 SD Card.....	87

3.15.2 SAMBA server	88
3.15.3 iSCSI	88
3.16 Continuous Recording Configuration	89
3.17 Recording List Configuration	90
3.17.1 Recording List	90
3.17.2 Continuous Recording List	91
3.18 Event Server Configuration	92
3.18.1 FTP Server	92
3.18.2 TCP Server	93
3.18.3 HTTP Server	94
3.18.4 SAMBA Server	95
3.19 Event Schedule Configuration	96
3.19.1 Setting	96
3.19.2 Record	99
3.19.3 Port Status	100
Appendix A: Ping IP Address	102
Appendix B: Bandwidth and Video Size Estimation	103
Appendix C: DDNS Application	104
Appendix D: Configuring Port Forwarding Manually	105
Appendix E: Power Line Frequency	108
Appendix F: Troubleshooting & Frequently Asked Questions	110

Chapter 1. Product Introduction

1.1 Package Contents

The package should contain the following:

- IP Camera Unit x 1
- Quick Installation Guide x 1
- Screw Package x 1
- Cable Gland x 1



Note

If any of the above items are missing, please contact your dealer immediately.

1.2 Overview

Suitable for Monitoring Extreme Outdoor Areas

PLANET ICA-M5380P Vandal-proof PoE IP Camera delivers excellent picture quality in H.265 3 mega-pixel resolutions at 30 frames per second (fps). Users will benefit from reduced 50% bandwidth and data storage through more efficient video compression.



Incorporating the Sony super low lux CMOS image sensor and 20-meter IR illuminators, which are specially designed for surveillance applications, the ICA-M5380P provides sharp images under all lighting conditions. With the motorized focus/zoom, users can remotely adjust the focus and zoom from the Web interface. Also equipped with a P-Iris, it allows for precise control of exposure, producing images with better clarity and contrast.

Moreover, it has an IP66 and IK10 rating housing that can withstand any harsh temperature ranging from -20°C to 50°C. Its outdoor and handy features enable you to easily install the camera in any public areas, such as buildings, gardens, parking areas, markets, balconies, railway stations and hospitals.

Clearer Images Delivered but Less Space Taken Up for Compression

The ICA-M5380P employs the H.265 technology to enable the camera to provide higher and more efficient image compression rates. If the same image quality level of H.264 is compared with that of H.265, the latter is able to save around 50% of bandwidth, meaning H.265 offers much higher quality video for less bandwidth. Thus, it can further enhance the overall performance of its IP surveillance system.

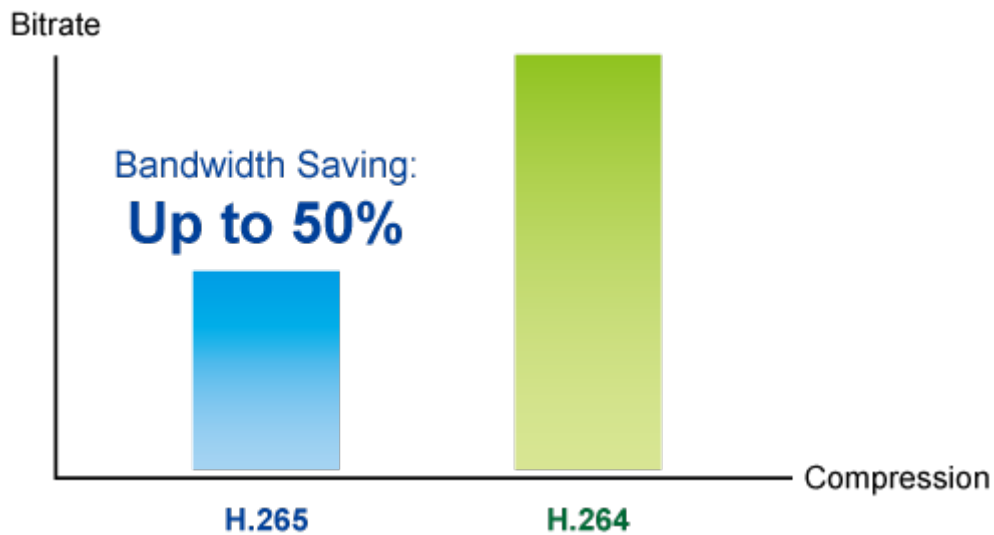

Smart Focus with P-Iris

The ICA-M5380P comes with the Smart Focus to make installation and adjustment easier by allowing remote focus and zoom adjustment. P-Iris function works by a stepping motor controlled via software to automatically provide the best iris position for the best exposure time in all lighting conditions.



Water Resistance and Dust-proof Protection

The IP66-rated housing protects the camera body against rain and dust, and ensures operation under extreme weather conditions, which makes it an ideal solution for outdoor applications, such as buildings, roads, parking areas, garages, railway stations and airports.



Advanced Media Management

The ICA-M5380P supports a number of advanced features to enhance surveillance flexibility and event management capabilities. The advanced features include 7 configurable regions of privacy mask to protect personal privacy and external ports that allow accessories, such as speakers and microphones, to be added to the camera for two-way audio function.

2-way Audio



Flexible Installation and Power Functionality

Powered from a PoE power sourcing equipment such as PoE switch or PoE injector over a network cable, the ICA-M5380P, adopting the IEEE 802.3af standard, does not need extra power cables and manpower, thus reducing installation costs while increasing deployment flexibility and scalability. The ICA-M5380P is ONVIF compliant and interoperable with other brands in the market. The ICA-M5380P is indisputably the ideal choice for reliable and high-performance surveillance.



1.3 Features

➤ Camera

- 1/2.8" Sony Exmor progressive scan CMOS sensor
- 2.8~12 mm vari-focal, P-Iris lens
- Smart Focus for remote and precise focus adjustment
- 0.01 lux minimum illumination at F1.2
- 12 built-in IR illuminators, effective up to 20 meters
- Removable IR-cut filter for Day & Night function

➤ Video and Audio

- Simultaneous H.265/H.264/M-JPEG video compression
- Simultaneous multi-stream support
- H.264 high profile, main profile and baseline
- Max. resolution of 2048 x 1536 at 30fps
- 3DNR to improve picture quality at low lux
- True WDR enhancement function strengthens visibility under extremely bright or dark environments
- Two-way audio support with enhanced audio quality

➤ Network and Configuration

- Compliant with IEEE 802.3af PoE interface for flexible deployment
- RTSP, FTP and PLANET DDNS protocols selectable

➤ Easy Installation and Management

- ONVIF compliant for interoperability
- IK10- and IP66rated housing for rigorous environment
- Intelligent motion, tampering, audio detection alarm
- Digital Input/Output for integration with sensors and alarms
- Easy configuration and management via Windows-based utility or web interface

1.4 Product Specifications

Model	ICA-M5380P
Camera	
Image Device	1/2.8" 3 mega-pixel Sony Exmor progressive scan CMOS sensor
Lens	Vari-focal 2.8~12mm, P-Iris Optical Zoom: 4x Angle of view: Horizontal: 29 ~ 94 degrees Vertical: 23 ~ 72 degrees
Min. Illumination	0.01 lux (color) @ F1.2 0 lux (B/W) @ IR on
IR Illuminations	IR LED x 12, 850nm, Built-in IR illuminators, effective up to 20 meters *The IR distance is based on the environment
Effective Pixels	2048 x 1536 pixels
Image	
Video Compression	H.265/H.264/M-JPEG
Video Resolution	2048 x 1536, 1080p, 960p, 720p, 800 x 600, 640 x 480, 640 x 360, 320 x 240, 320 x 180
Frame Rate	Up to 30fps for all resolutions
Bitrate	1024~20000kbps
Shutter Time	1/5~1/10000 sec
Image Setting	AE, AWB 2D noise reduction 3D noise reduction D-WDR/True WDR Brightness, contrast, sharpness, hue, color Anti-False Color Defog Digital Image Stabilization (DIS) BLC Pixel Count Mirror/Flip Privacy mask (7 regions) Text, time and date overlay Overlay image on video
Streaming	Simultaneous multi-profile streaming Streaming over UDP, TCP, HTTP, or HTTPS Controllable frame rate and bandwidth M-JPEG streaming over HTTP (server push) Constant and variable bit rate ROI AOI (Higher Quality in AOI area)
Audio	
Audio Streaming	Two-way audio
Audio Compression	RTSP: G.711/G.726
Audio Input	External microphone input
Audio Output	Adjustable audio output gain

Network and Configuration	
Standard	IEEE 802.3 10BASE-T IEEE 802.3u 100BASE-TX IEEE 802.3af Power over Ethernet
Protocol	IPv4, Ipv6, TCP, UDP, HTTP, HTTPS, SMTP, FTP, NTP, DNS, PLANET DDNS, DHCP, Bonjour, UPnP, RTSP, RTP, RTCP, PPPoE, Samba, SNMP, QoS, IEEE 802.1x
Security	Password protection, IP address filtering, HTTPS encrypted data transmission
Users	On-line monitoring of 20 clients at the same time
System Integration	
Application Programming Interface	Open API for software integration ONVIF compliant
Alarm Triggering	Motion detection, tampering, disconnection of network or audio and external input
Alarm Events	File upload via FTP, Samba or email Notification via email, HTTP, and TCP External output activation Audio alert output ICR On/Off
General	
Power Requirements	12V DC, 1A IEEE 802.3af Class 3
Power Consumption	10W with IR on (12V DC) 10W with IR on (PoE)
Weight	865g
Dimensions (Φ x L)	140 x 131 mm
Emission	CE, FCC
Housing	IK10- and IP66-rated
Connectors	10/100Mbps Ethernet, RJ45 1 alarm input and 1 alarm output (terminal block) 12V DC (terminal block) External mic input (terminal block) Audio out (terminal block) Video out (terminal block) Factory default reset button Micro SD slot (max. 32GB, class 10)
Environments	
Cold Temperature Boot	-20 ~ 50 degrees C
Operating Temperature	-30 ~ 50 degrees C
Operating Humidity	20 ~ 80% (non-condensing)

Chapter 2. Hardware Interface

2.1 Physical Descriptions

2.1.1 Identification of ICA-M5380P Physical Details





Item	Description
Lens	Keep the lens clean for an excellent video quality.
IR LED	Emits infrared light to provide light source in dark places
Light Sensor	<p>Detects the illumination level or the place where this IP camera is installed, and switches IR LEDs on when it's required.</p> <div style="border: 1px solid black; padding: 5px;"> <p> Note When IR LEDs are switched on, this IP camera will switch to black and white video mode to enhance video quality. Do not cover light sensor or this IP camera will work in black and white mode only.</p> </div>

2.1.2 Inside View



Description of I/O Cabling:

Interface	Description
LAN Port (802.3af PoE)	<ul style="list-style-type: none"> ● Connecting to PC or Hub/ PoE Switch Connects the onboard LAN port to your local area network by Ethernet cable. For connection to 10BASE-T Ethernet or 100BASE-TX or Fast Ethernet cabling, this Ethernet port built auto-negotiation protocol can detect or negotiate the transmission speed of the network automatically. Please use CAT-5e cable to connect the Network Camera to a 100Mbps Fast Ethernet network switch or hub. ● LED <ol style="list-style-type: none"> 1. LAN LED (green color): This LED will be flashing while network accessing via Ethernet. 2. Power LED (orange color): When the camera is powered on, the LED will be always on. <div style="border: 1px solid black; padding: 5px; margin-top: 10px;">  ONLY use one power source, either from DC or from 802.3af Power over Ethernet. </div>

Interface	Description
DC 12V Connector	The input power is 12V DC, 1A. (The power adapter is not included in the package)
Reset Button	<p>This button supports two functions: “Restore to factory default setting” and “Auto focus”.</p> <ul style="list-style-type: none"> ● Restore to factory default setting: <ol style="list-style-type: none"> 1. Turn off the camera first. 2. Press and hold the button continuously. Power on this camera. Wait until orange LED is turned on. It will take about 30 seconds. Once the Camera is operational again, the device has restored to default settings. <div style="border: 1px solid black; padding: 5px; margin: 5px 0;">  <p>Note Restoring the factory default setting will lose all the previous settings including IP address forever. User needs to run the IPWizard II program to search the device and configure it to let the device work properly again.</p> </div> <ul style="list-style-type: none"> ● Auto focus: <ol style="list-style-type: none"> 1. The camera should be powered on and ready. 2. Press the button for 5 seconds to enable the camera to adjust the focus automatically.
MicroSD Card Slot	Supports micro SD/SDHC cards. Inserts a memory card (not included) into this slot for local recording purposes.
Terminal block	<ul style="list-style-type: none"> ● MIC +/- (audio in): Connect an external microphone to the camera. ● Audio out: Connect a loud speaker to the camera. This function is for voice alerting and two-way audio. ● Analog GND: This ground is for audio/video analog signal. ● Video out: Connect a TV display to the camera. This function is for camera adjustment on site. Furthermore, the video output is off by default. To turn on video, please refer to Setting\Camera\Picture chapter. ● 5V out: This is used to support DI/DO devices. The output power is 5VDC/50mA maximum. ● DI/GND/DO: Interface of Digital input/output

Terminal Block for I/O Connectors:

Pin	Name	Function
1	MIC -	External microphone input-
2	MIC +	External microphone input+
3	A/out +	Audio signal output
4	A/out -	Analog signal ground
5	Video out	TV signal output
6	5V/out	DC 5V output (50mA maximum)

Pin	Name	Function
7	DI	Digital signal input
8	GND	Ground
9	DO	Digital signal output

User can refer to the diagram below to make a proper connection between I/O connector and external sensor and output device.

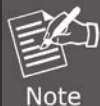
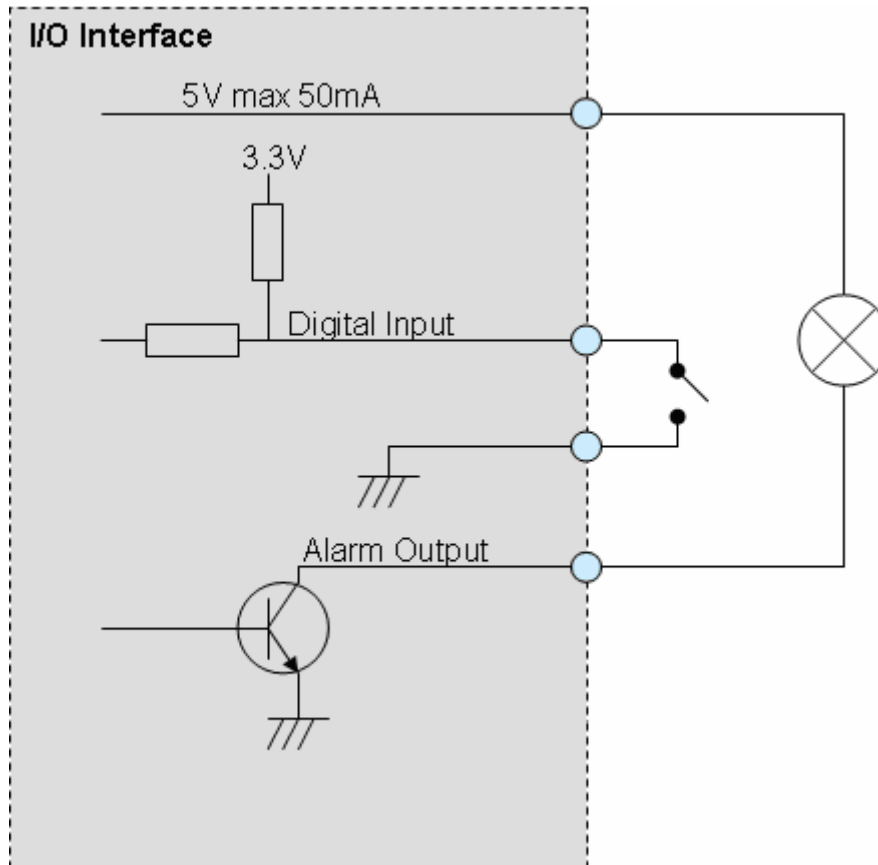

Note

1. The low voltage/current circuits and high voltage/current circuits are in the network camera circuit. Only a qualified electrician should do the wiring, not yourself. Incorrect wiring could damage the network camera and you might get a fatal electric shock.
2. The external I/O is not capable of connecting directly to devices that require large amounts of current. In some cases, a custom interface circuit (customer provided) may have to be used. Serious damage to the network camera may result if a device is connected to the external I/O that exceeds its electrical capability.

2.2 Hardware Installation

1. Open the cover:

Use the provided L-wrench to loosen the screws of the tamper-resistant housing cover. The unit has a factory-installed side entry conduit and cables can be adjusted to suit the rear entry conduit in accordance with the installation requirements.

2. Place the Camera on the ceiling or fix it onto wall:

Use three screws to fix the camera onto the ceiling or wall.



The unused screw holes should be made waterproof when installing the camera. It is helpful to prevent the steam from entering the camera.

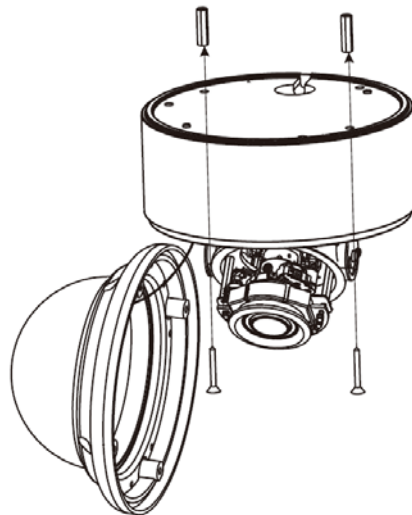

3. Plug an Ethernet cable into the Camera:

Insert the cable gland into an Ethernet cable (not included in the package). It is recommended to use exterior-grade Ethernet cable that is already waterproof. Attach the cable gland to the hole of the camera. Connect the Ethernet cable to the LAN socket.



1. The unused cable outlet hole must be closed, and the cable gland on the used hole must be locked closely.
2. When you connect cables to camera, we advise to use a hose to include all the cables inside instead of plugging in several cables separately, because water may seep down the gap of cables into machine. You can also seal the connector hole with silicone after installation.

4. Check the LED indication

As the camera adopts the IEEE 802.3af standard, its Ethernet cable can be connected to a PoE switch to obtain power.

Once IP camera is properly installed and powered on, the power LED will be lit in orange, meaning the system is booting up successfully. Furthermore, if you have a proper network connection, and access to the camera, the LAN LED will flash green.

 Note	<p>The power supplied to the camera is supported via a PoE switch or DC adapter. However, the DC adapter is unnecessary when Internet camera is connected to the PoE switch. Otherwise, the camera may be damaged once it is connected to the PoE switch and power adapter simultaneously.</p>
---	--

5. Adjust the angle of lens:

Adjust the proper angle by moving the camera body. The angle of adjustment for pan ranges from 45 to 315 degrees and for tilt, 0 to 90 degrees.

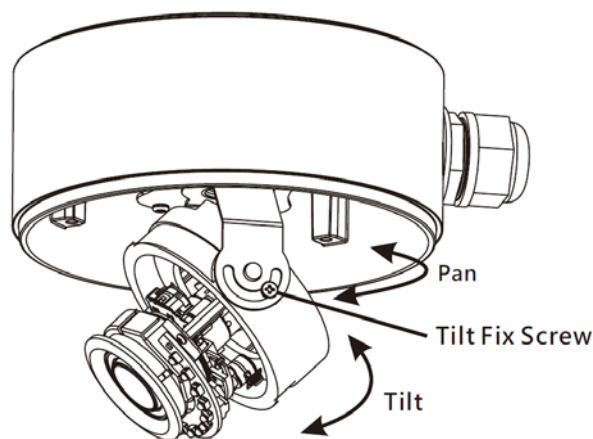

6. Adjustment done

Before you close the dome cover, make sure that the rubber band sticks to the inside of the cover completely. Crooked or uneven rubber band may cause the waterproof defective.

Lock tightly the screws on the dome cover to ensure there's no gap between the lid and base.

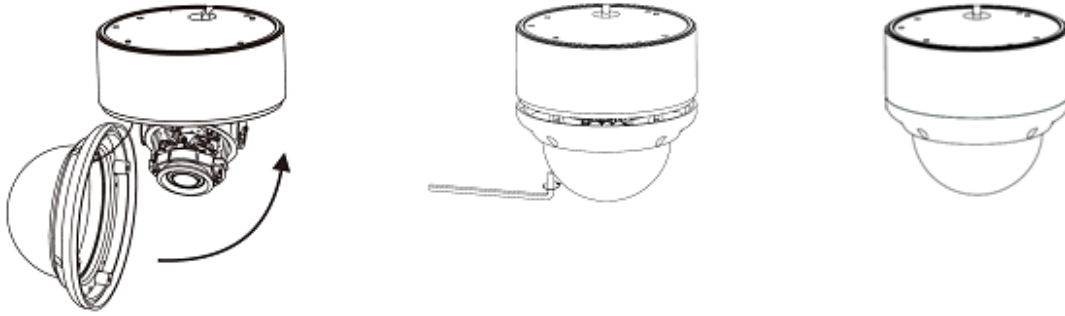

2.3 Initial Utility Installation

This chapter shows how to quickly set up your IP camera. The camera is with the default settings. However to help you find the network camera quickly, the windows utility PLANET IP Wizard II can search the cameras in the network that can help you to configure some basic settings before you start advanced management and monitoring.

1. Go to PLANET website and download the search tool:

http://www.planet.com.tw/en/product/images/48885/UT-PLANET_IPWizardII_v3.0.0.7974.zip

2. Unzip and install the PLANET IP Wizard II, and a dialog box will appear as shown below:

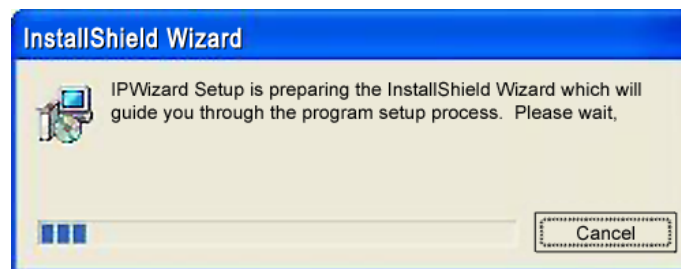

3. The “Welcome to the Install Shield Wizard for PLANET IP Wizard II” prompt will display on the screen and click “**Next**” to continue.

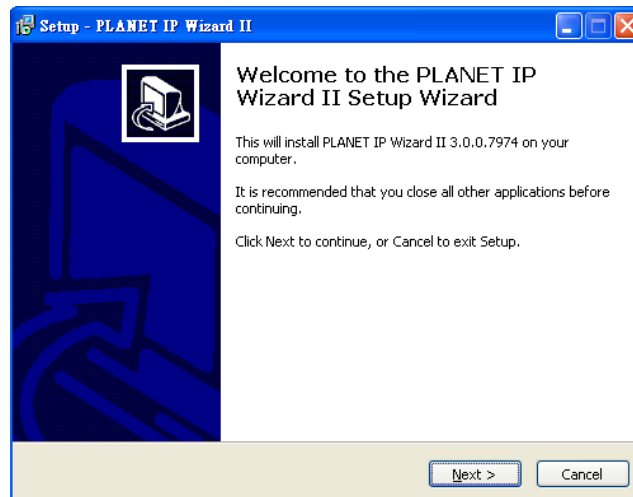

4. Please click “**Next**” to install with original settings, or you may click the “**Browse...**” button to modify the install folder and then press “Next” to continue.

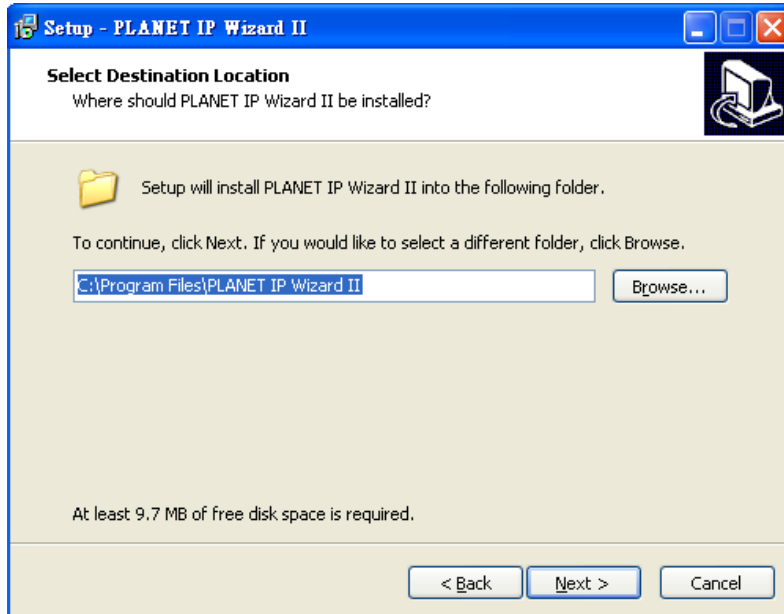

5. Please click “**Install**” to start the installation.

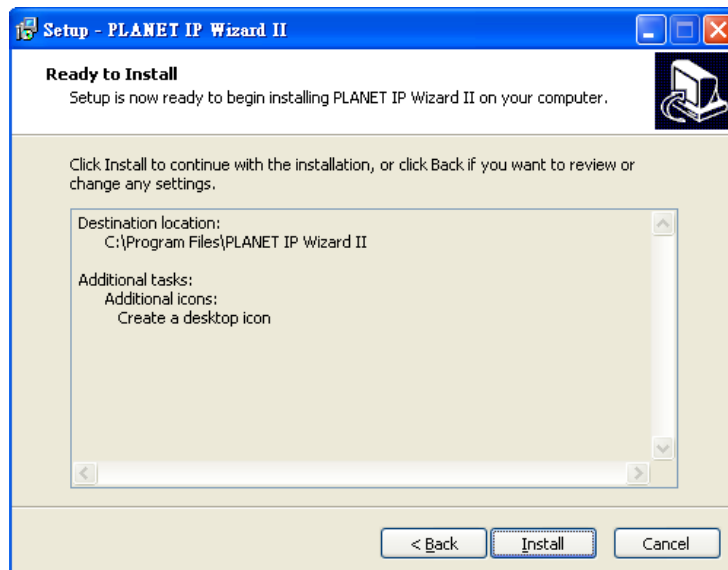

6. Please click **Finish** to complete the installation and launch program immediately.



2.4 Preparation

When you install the Internet camera in a LAN environment, you may execute PLANET IP Wizard II to discover camera's IP address and set up related parameters in the camera.

2.4.1 Search and View by PLANET IP Wizard II

When you install the Internet Camera in a LAN environment, you have two easy ways to search your cameras either by PLANET IP Wizard II or UPnP discovery. Here is the way to execute PLANET IP Wizard II to discover camera's IP address and set up related parameter in a camera.

Search

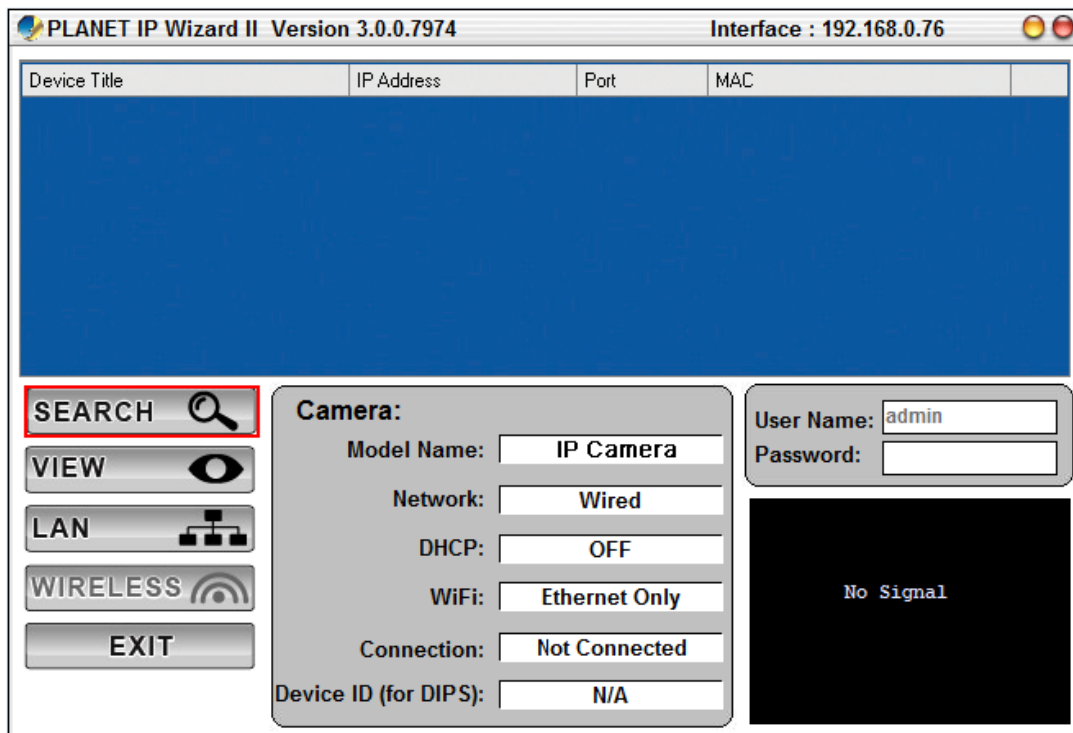

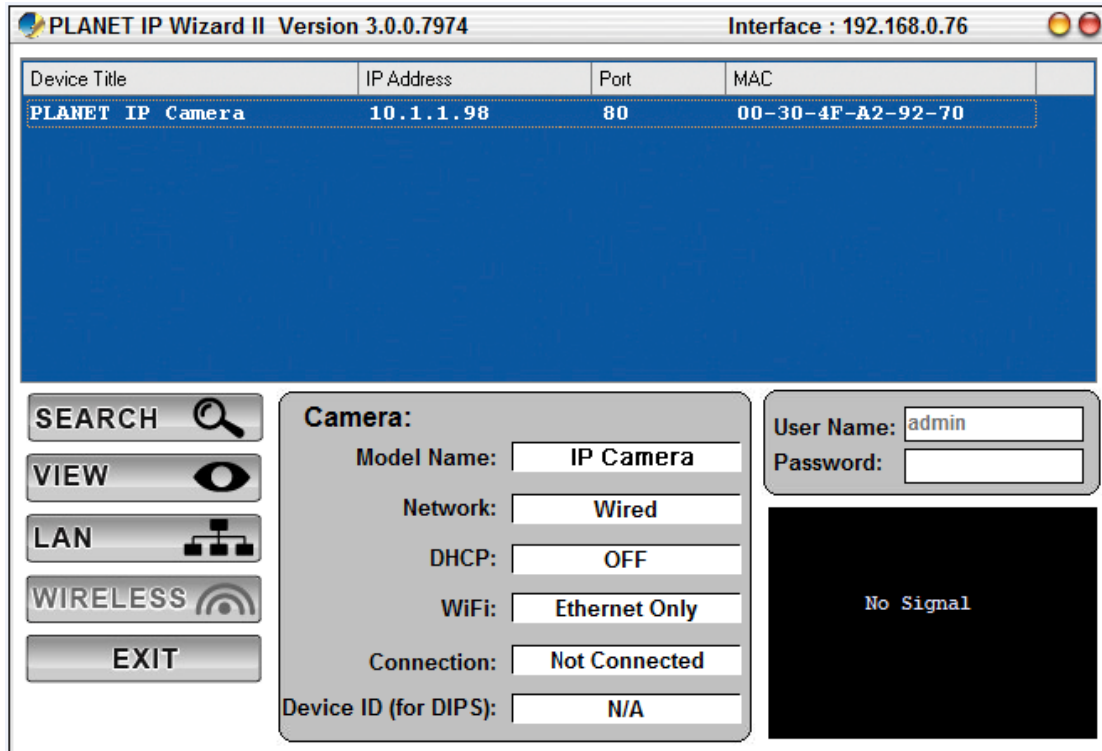

When launching the Planet IP Wizard II, the “searching” window will pop up. Planet IP Wizard II is starting to search Internet cameras on the LAN. The existing devices are listed below.





PLANET IP Wizard II Version 3.0.0.7974 Interface : 192.168.0.76

Device Title	IP Address	Port	MAC
PLANET IP Camera	10.1.1.98	80	00-30-4F-A2-92-70

SEARCH 

VIEW 

LAN 

WIRELESS 

EXIT

Camera:

Model Name:

Network:

DHCP:

WiFi:

Connection:

Device ID (for DIPS):

User Name:

Password:

No Signal

2.4.2 Configuring Network by PLANET IP Wizard II

In case you want to change the IP related parameters of wired interface, please select the Internet camera you want to configure and click the LAN button. Related settings will be carried out as shown below.

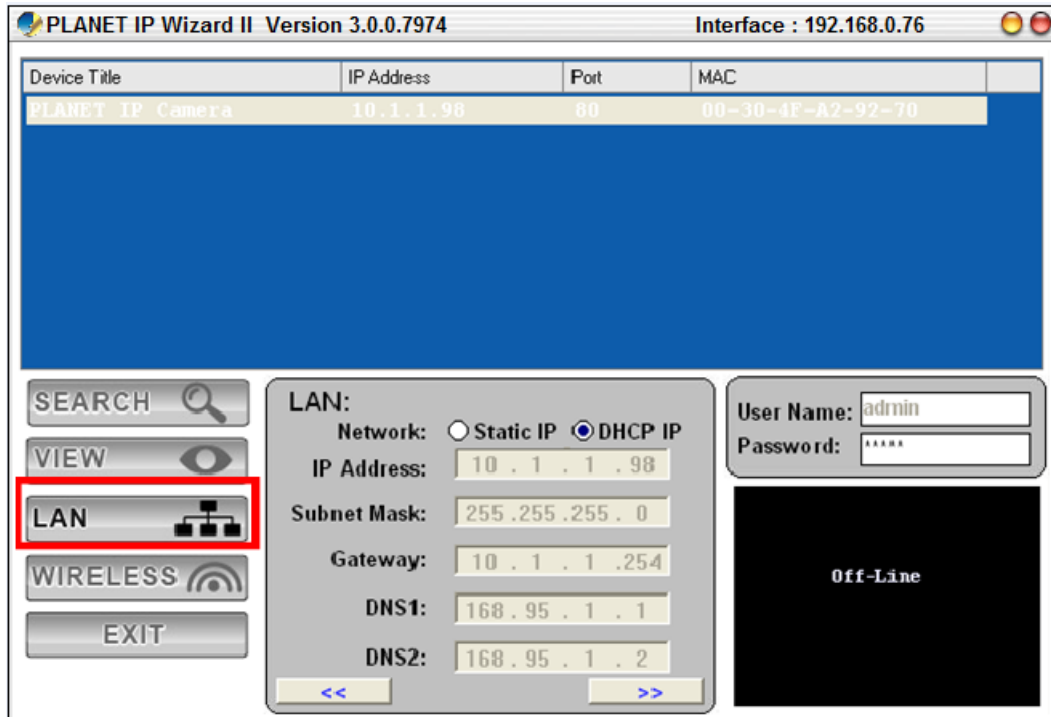

In case, you do not want to change username and/or password, then just click the **“Submit”** button to perform your setting accordingly. Click the **“<<”** button to go back to the previous page.

If you like to change password of the device, just click the check button. Then, the related fields will show up as shown below.

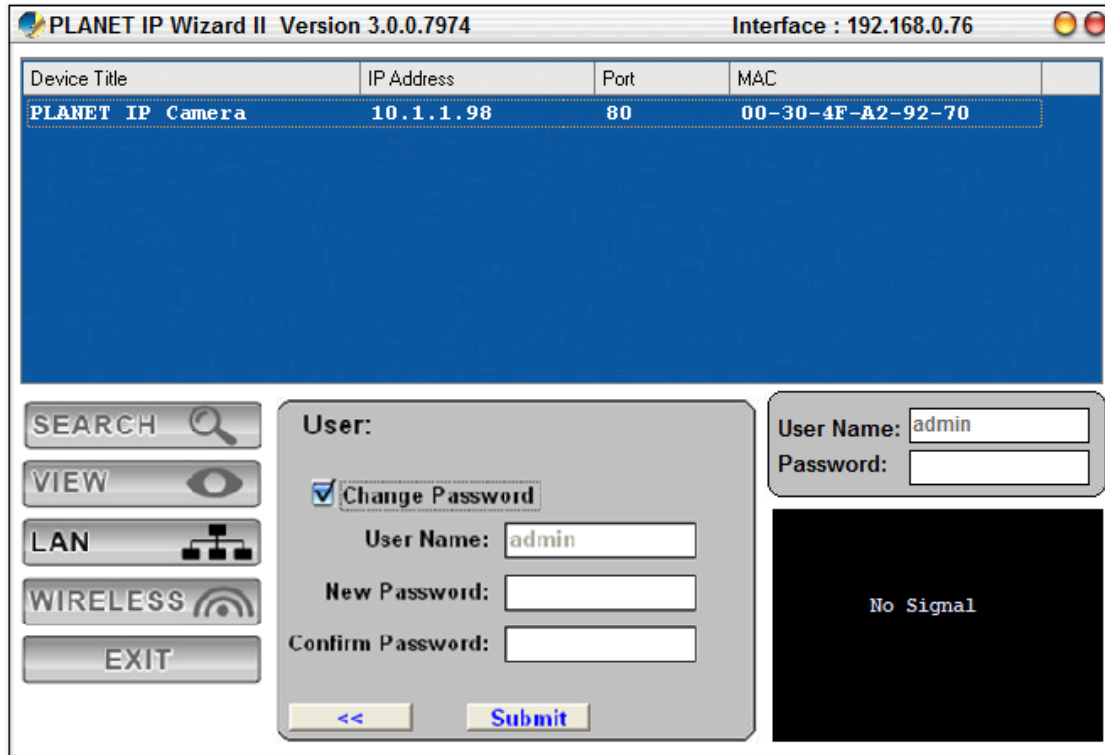



PLANET IP Wizard II Version 3.0.0.7974 Interface : 192.168.0.76

Device Title	IP Address	Port	MAC
PLANET IP Camera	10.1.1.98	80	00-30-4F-A2-92-70

SEARCH 

VIEW 

LAN 

WIRELESS 

EXIT

User:

Change Password

User Name:

New Password:

Confirm Password:

User Name:

Password:

No Signal

After keying in the new password, click the “**Submit**” button to perform your setting accordingly. Click the “<<” button to go back to the previous page.

2.5 Using UPnP of Windows XP or 7

2.5.1 Windows XP

UPnP™ is short for Universal Plug and Play, which is a networking architecture that provides compatibility among networking equipment, software, and peripherals. This device is an UPnP enabled device. If the operating system, Windows XP, of your PC is UPnP enabled, the device will be very easy to configure. Use the following steps to enable UPnP settings only if your operating system of PC is running Windows XP.



Please note that MS Windows 2000 does not support UPnP feature.

Go to **Start > Settings**, and click **Control Panel**.

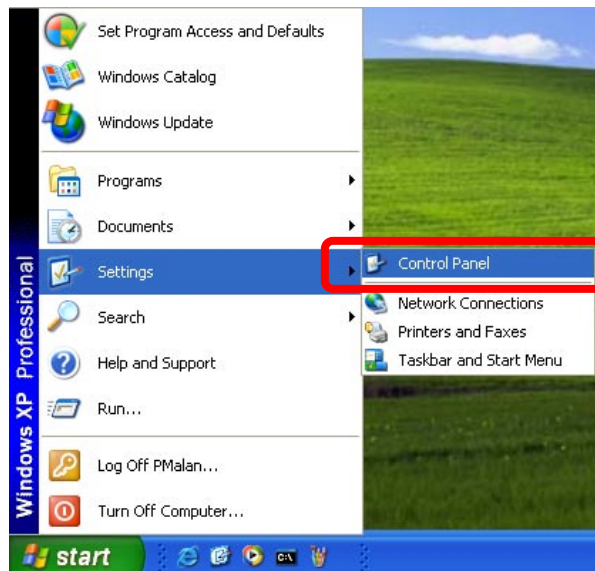

The **“Control Panel”** will display on the screen and double-click **“Add or Remove Programs”** to continue.

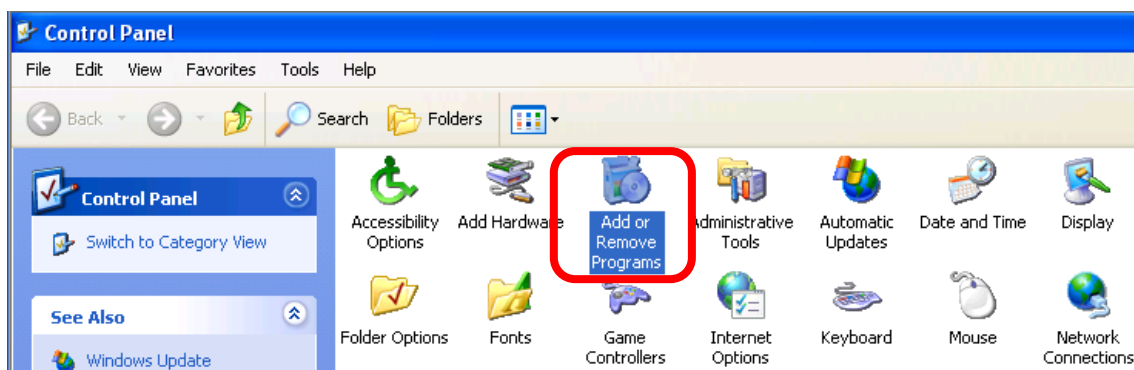

The “Add or Remove Programs” will be displayed on the screen and click **Add/Remove Windows Components** to continue.

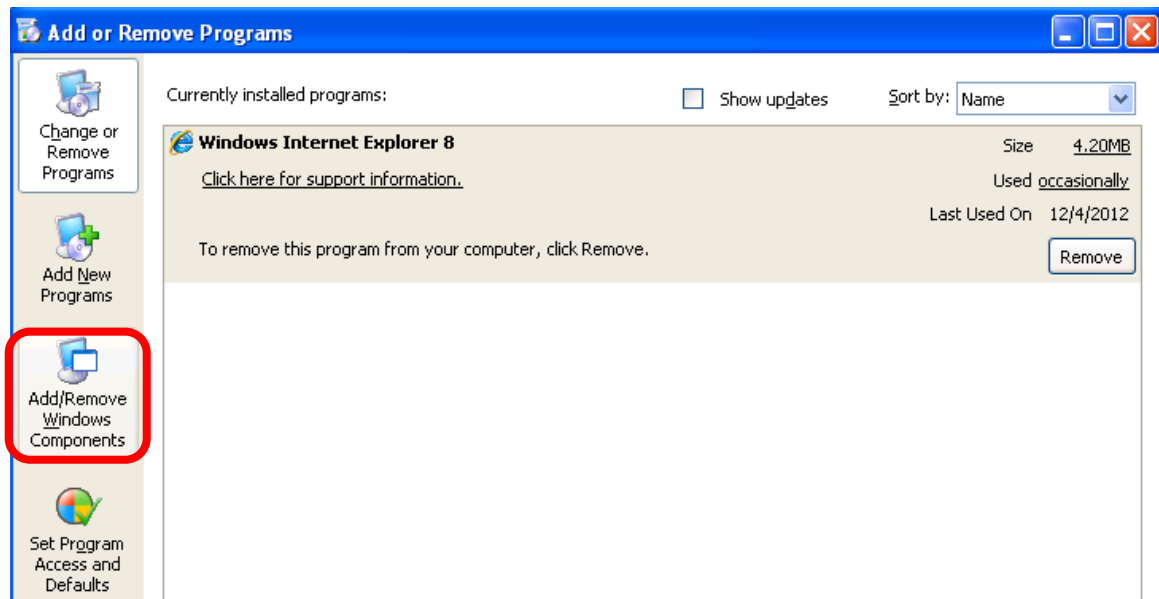

The following screen will appear; select “**Networking Services**” and click “**Details**” to continue.

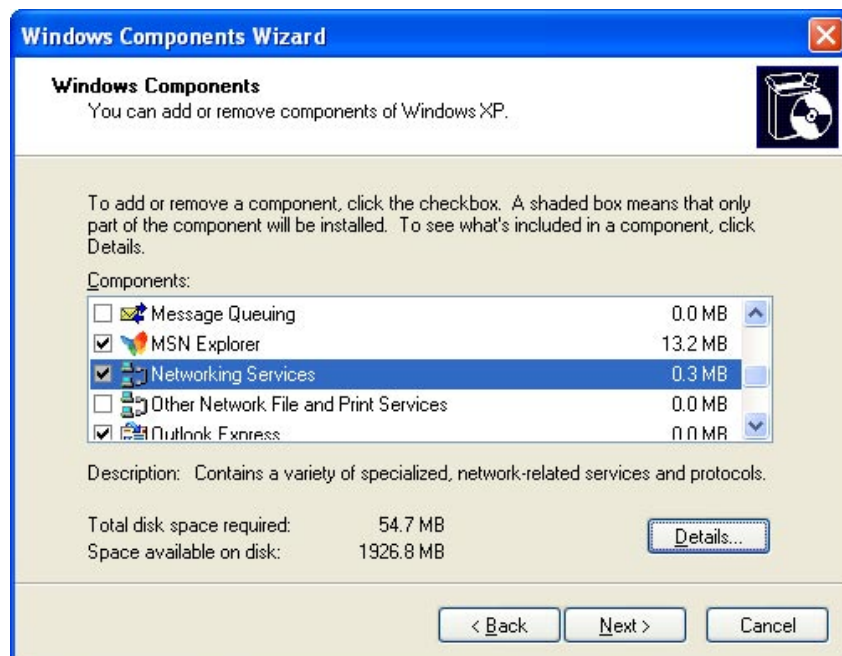

The “Networking Services” will be displayed on the screen; select “**Universal Plug and Play**” and click “**OK**” to continue.

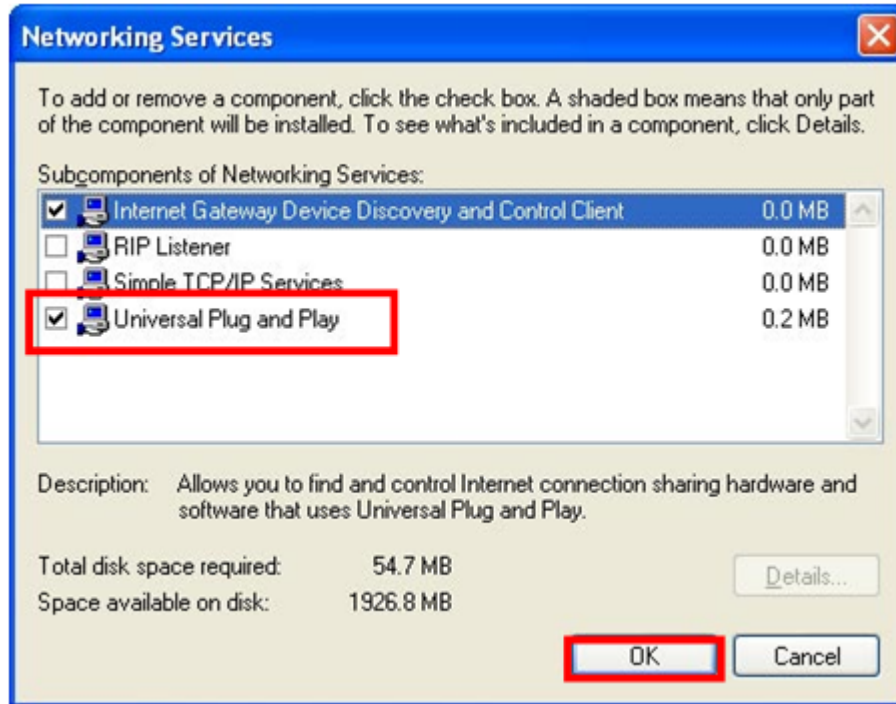

Please click “**Next**” to continue.

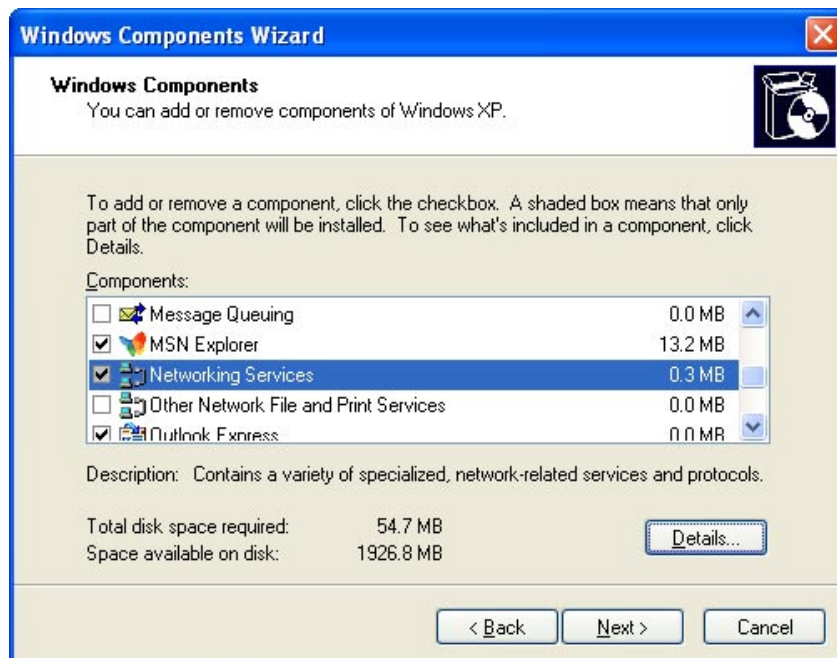

The program will start installing the UPnP automatically. You will see the pop-up screen below. Please wait while Setup configures the components.

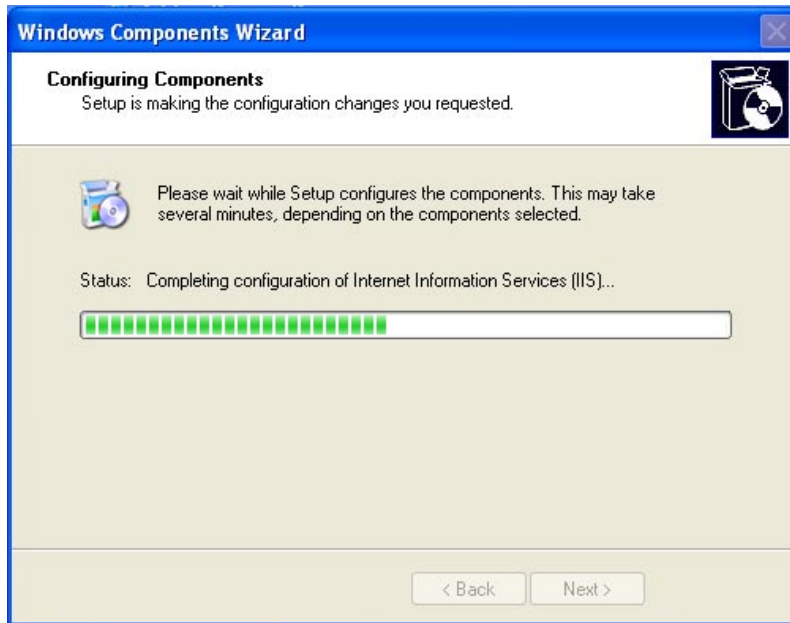



Please click **Finish** to complete the UPnP installation.

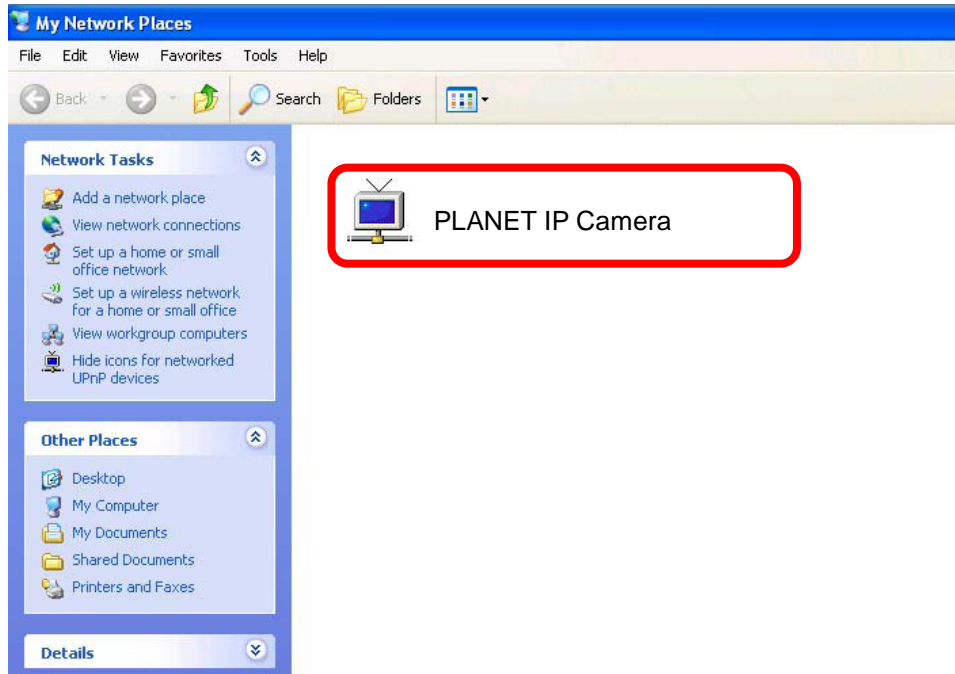

Double-click **“My Network Places”** on the desktop, and the “My Network Places” will be displayed on the screen and double-click the UPnP icon with Internet Camera to view your device in an Internet browser.



2.5.2 Windows 7

Go to **Start > Control Panel > Network and Internet > Network and Sharing Center**, if network discovery is off; click the arrow button  to expand the section. Click Turn on network discovery, and then click Apply.  If you are prompted for an administrator password or confirmation, type the password or provide confirmation.

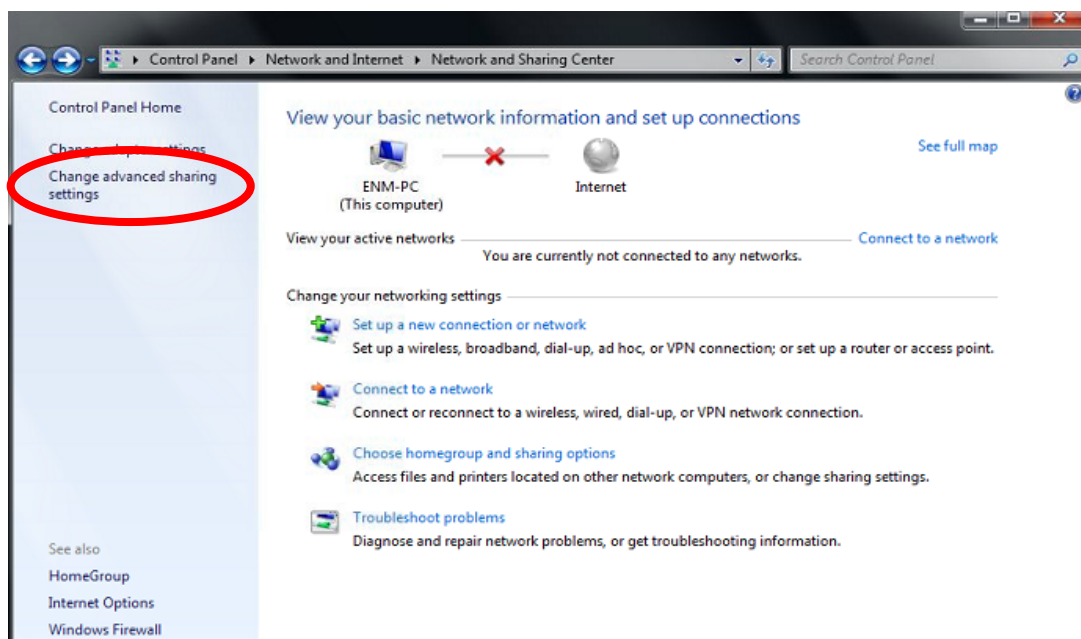

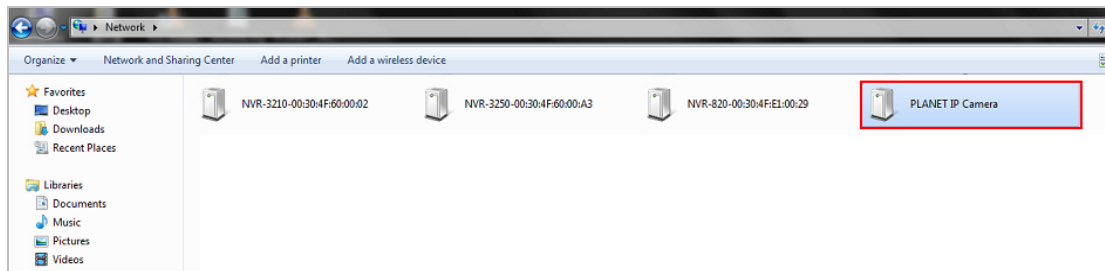
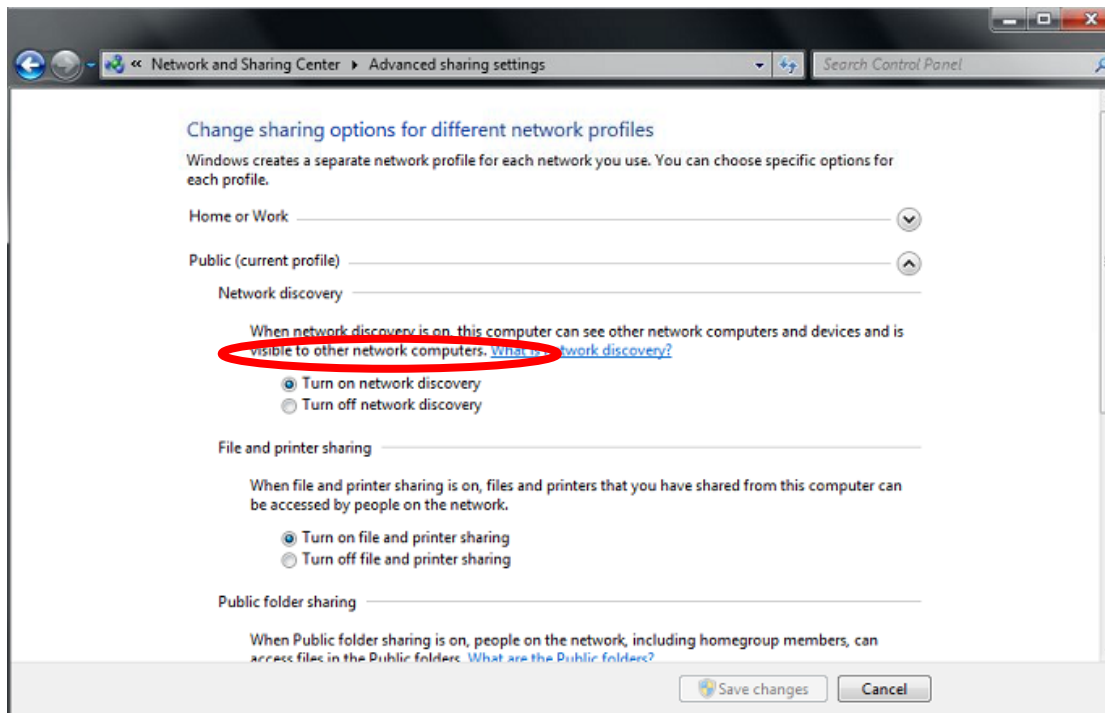

2.6 Setup ActiveX to use the Internet Camera

The Internet Camera web pages communicate with the Internet camera using an ActiveX control. The ActiveX control must be downloaded from the Internet camera and installed on your PC. Your Internet Explorer security settings must allow for the web page to work correctly. To use the Internet camera, user must set up his IE browser as follows:

2.6.1 Internet Explorer 6 for Windows XP

From your IE browser → “Tools” → “Internet Options...” → “Security” → “Custom Level...”, please set up your “Settings” as follows:

Set the first 3 items

- Download the signed ActiveX controls
- Download the unsigned ActiveX controls
- Initialize and script the ActiveX controls not marked as safe to Prompt

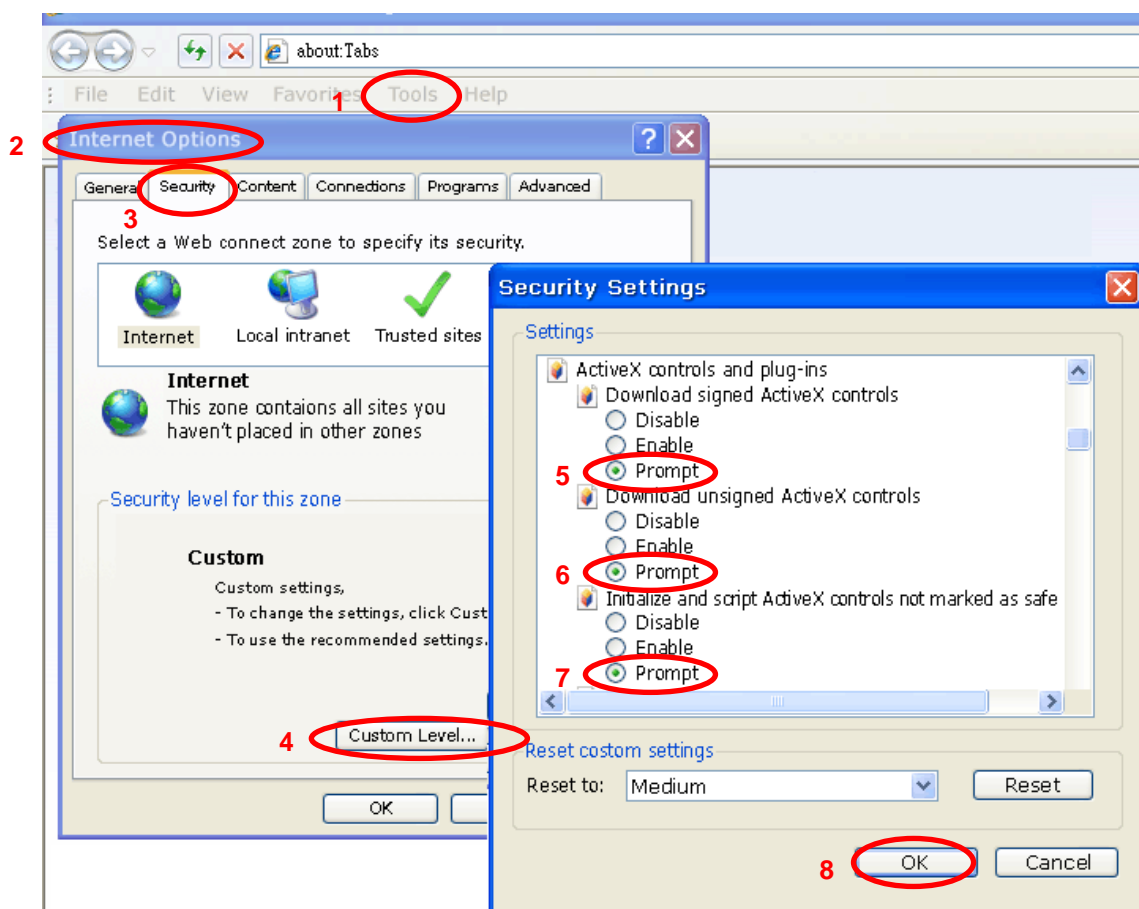

By now, you have finished your entire PC configuration for Internet camera.

2.6.2 Internet Explorer 7 for Windows XP

From your IE browser → "Tools" → "Internet Options..." → "Security" → "Custom Level...", please set up your "Settings" as follows:

Set the first 3 items

- *Allow previously unused ActiveX control to run...*
- *Allows Scriptlets*
- *Automatic prompting for ActiveX controls*

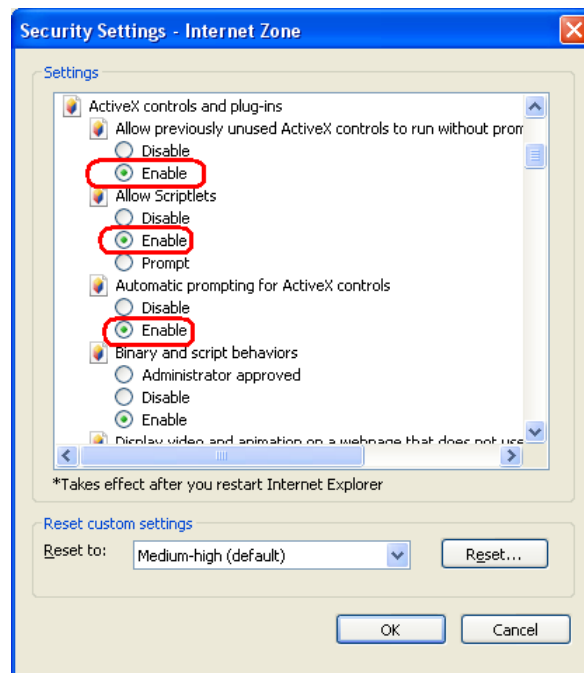

By now, you have finished your entire PC configuration for Internet camera.

2.6.3 Internet Explorer 7 for Windows Vista

From your IE browser → "Tools" → "Internet Options..." → "Security" → "Internet" → "Custom Level...", please set up your "Settings" as follows:

- *Enable "Automatic prompting for ActiveX controls"*
- *Prompt "Initialize and script active controls not marked..."*

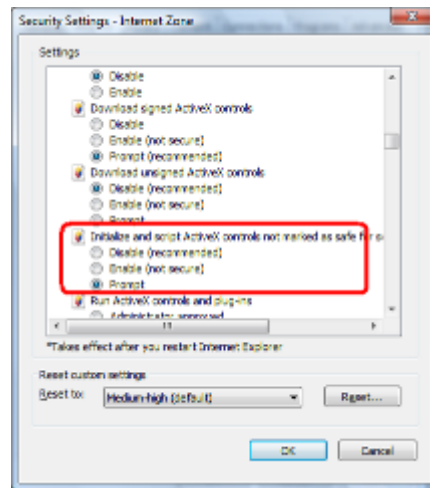
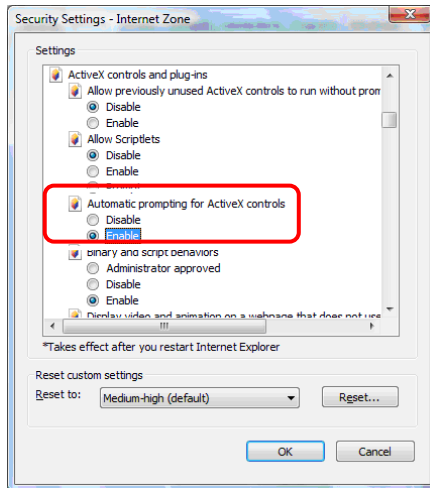

From your IE browser → "Tools" → "Internet Options..." → "Security" → "Trusted Sites" → "Custom Level...", please set up your "Settings" as follows:

- Enable "Automatic prompting for ActiveX controls"
- Prompt "Initialize and script active controls not marked..."

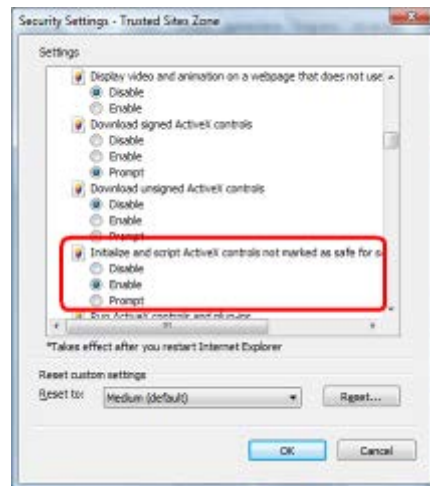
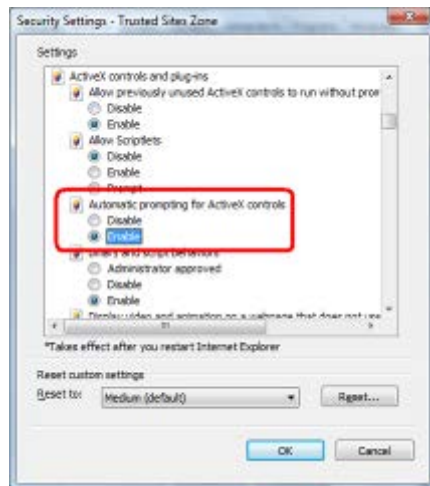

By now, you have finished your entire PC configuration for Internet camera.

Chapter 3. Web-based Management

This chapter provides setup details of the Internet camera's Web-based Interface.

3.1 Introduction

The Internet camera can be configured with your Web browser. Before configuring, please make sure your PC is under the same IP segment with Internet camera.

3.2 Connecting to Internet Camera

1. Start the web browser on the computer and type the IP address of the camera.

The Default IP: "<http://192.168.0.20/>"

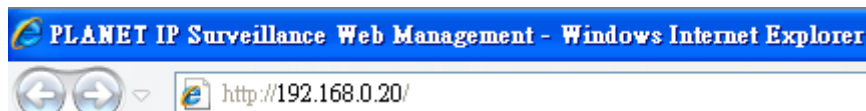

2. The login window of Internet camera will appear.

Default login username and password are both **admin**.

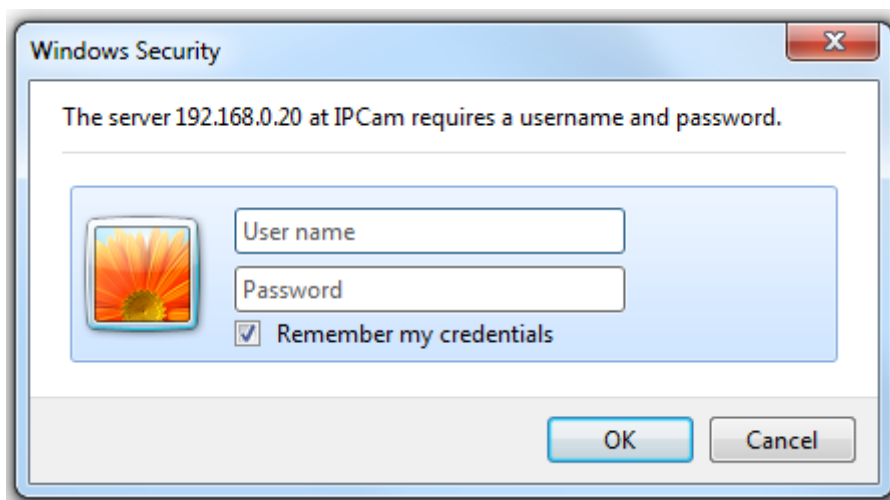

If the password has been changed with PLANET IP Wizard II, please enter the new password.

3. After logging in, you will see the following message at the top of Internet Explorer:



If user using IE browser 11, the message might not show. Please click the **Tools** button and select Compatibility View settings.

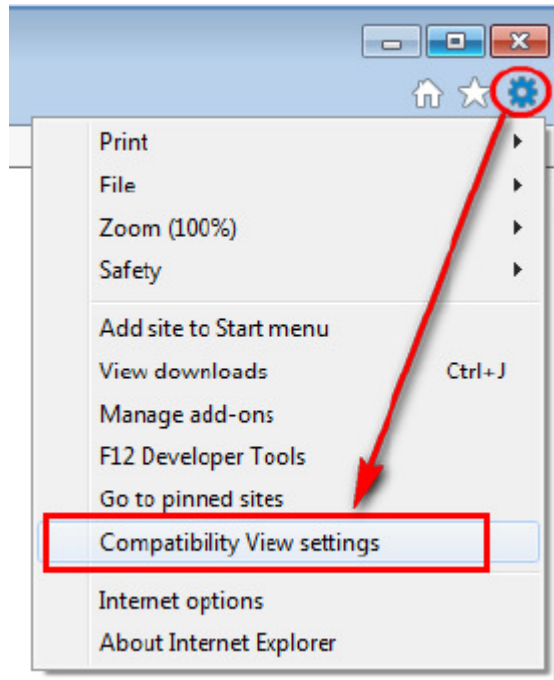

Click the **Add** button to add camera webpage as a compatible website.

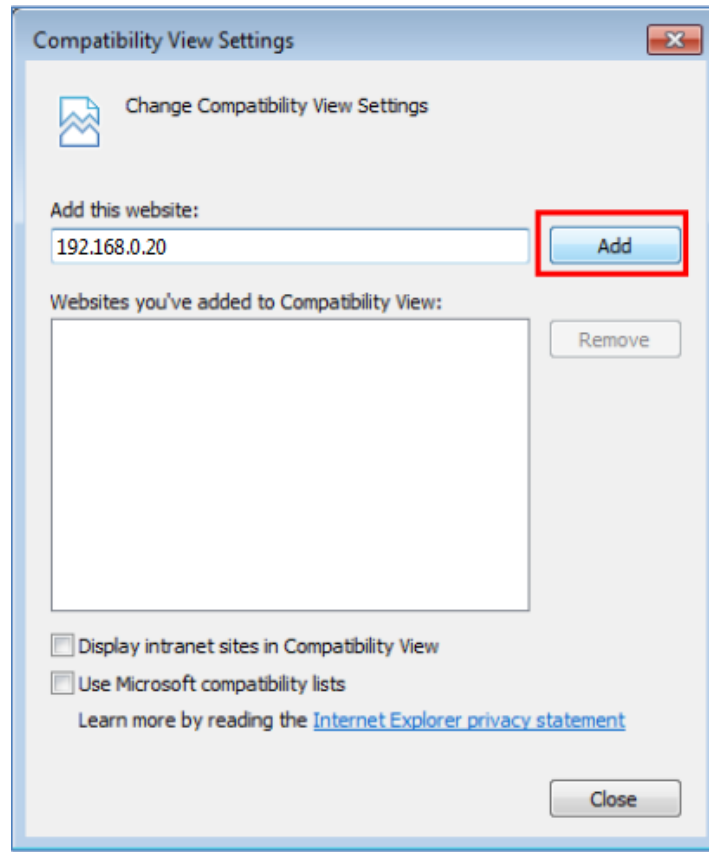

After a successful addition, camera's IP address should be set as compatible view website.

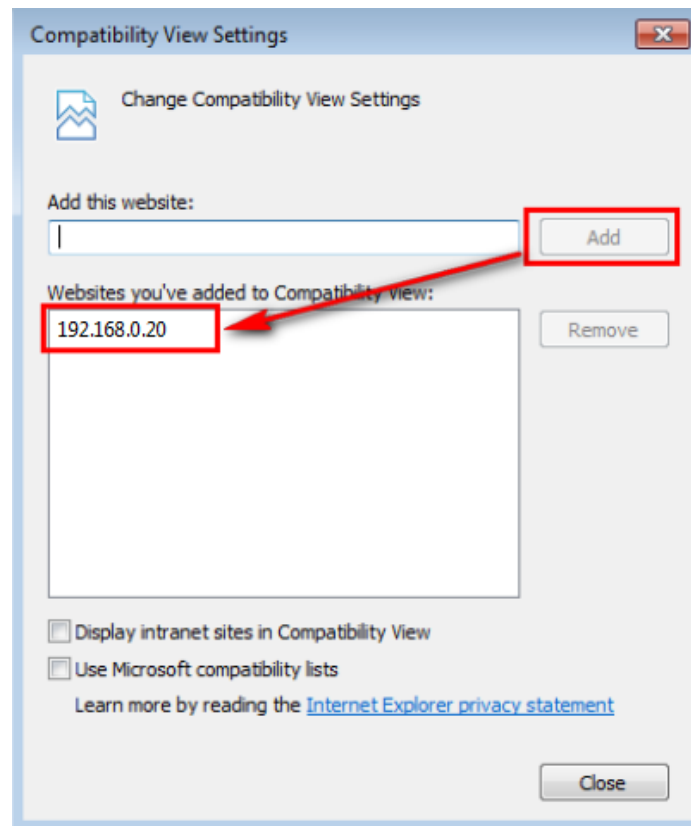

Click on the message, and click **Run Add-on**

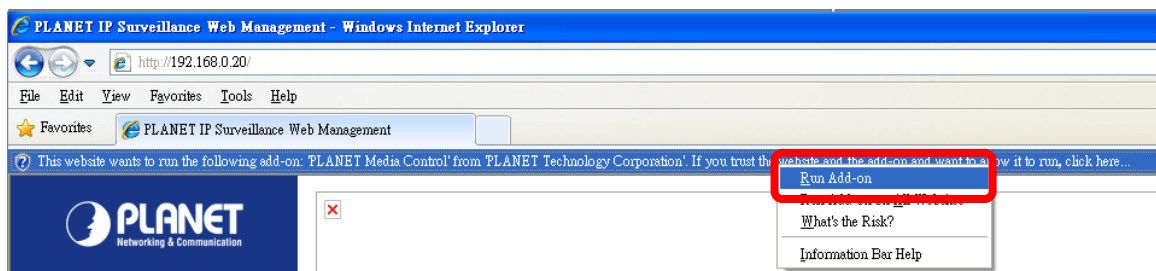

When you see this message, click **Run** to install the required ActiveX control.



After the ActiveX control has been installed and run, the first image will be displayed. You will be able to see the images captured from the IP camera on the web page now. For advanced functions, please refer to instructions given in the following chapters.

 Note	If you log in the camera as an ordinary user, setting function will not be available. If you log in the camera as an administrator, you can perform all the settings provided within the device.
--	--

3.3 Live View

Start-up screen will be as follows whether you are an ordinary user or an administrator.

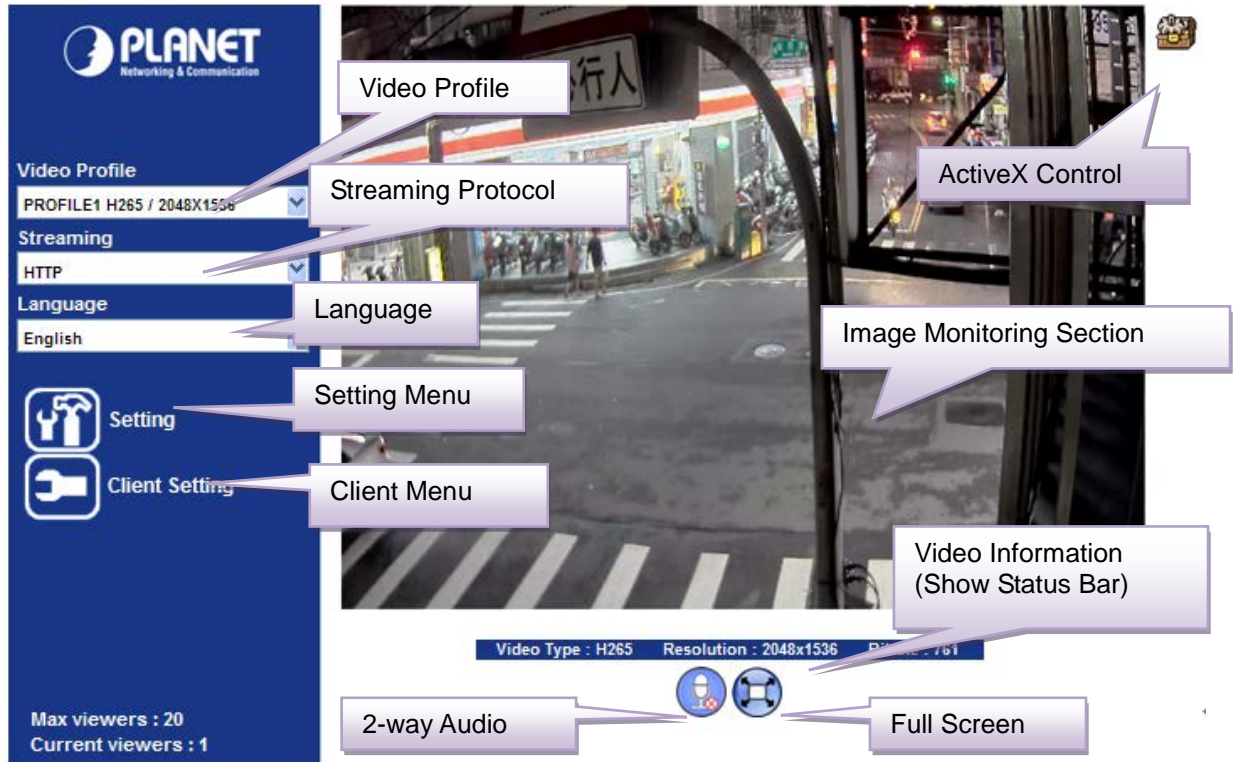

Image Monitoring Section

The image shot by the camera is shown here. The date and time are displayed at the top of the window.

Video Profile

The camera supports multi-profile for simultaneous H.265, H264 and M-JPEG compressions. User can choose a proper and/or preferred profile here.

Full Screen

Click this button to display the image in full-screen mode (uses every available space to display the image captured by this camera).

2-way Audio

The Internet camera supports 2-way audio function. User can choose to enable or disable this function by toggling the icon below



: Disable audio uploading function.



: Enable audio uploading function.

ActiveX Control

The plug-in ActiveX control supports a lot of functions by clicking the

left mouse button. Note that this feature only supports on the ActiveX control within Microsoft® Internet Explorer.

Setting Menu This function is in a detailed setting for the camera that is only available for user logged into camera as administrator.

Streaming Protocol User can select proper streaming protocol according to networking environment.

Language The device can provide multiple languages to meet customer's requirements.

Client Setting: Click this button to display the client extra control panel for 2-way audio and full screen.

Video Information Display video information including video format, resolution, frame rate and bit rate.

3.4 ActiveX Control

The plug-in ActiveX control supports a lot of functions by clicking the left mouse button. Note that this feature only supports on the ActiveX control within Microsoft® Internet Explorer.

On the ActiveX control icon, click the left mouse button and then a menu pops up. This menu provides features that are unique to the ActiveX control. These features include:

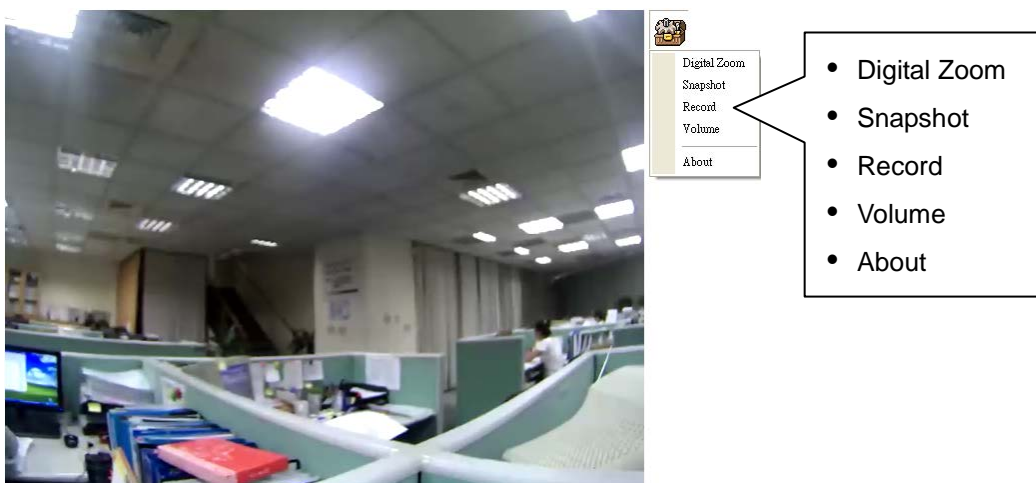

3.4.1 Digital Zoom

Click **Digital Zoom** to activate this function shown below. User can drag or scale the box over

the video to adjust zoom ratio and position.

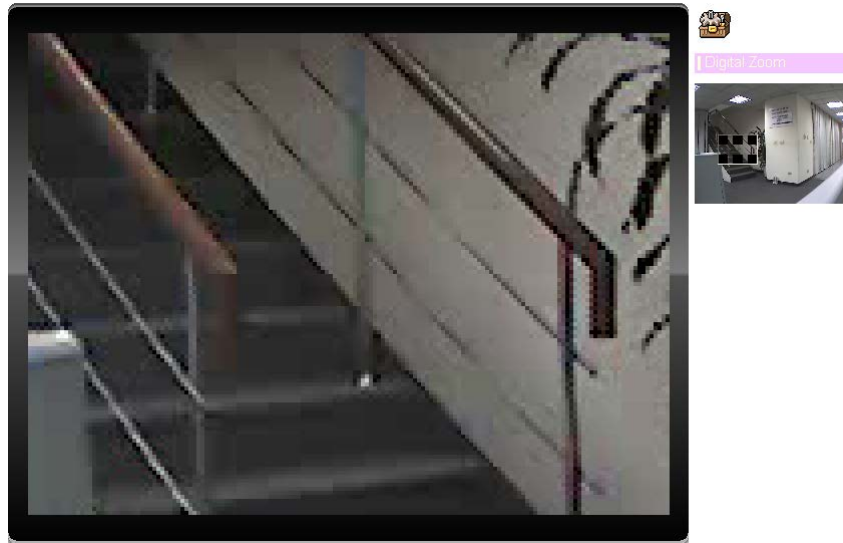

3.4.2 Snapshot

Click **Snapshot** to activate this function. Press the **Snapshot** button to take a picture. The image file is saved as JPEG format onto your local PC. Select **Browser** and a window pops up prompting you to select the save path and file name prefix, and select **OK** to continue.

If you like to retrieve the saved image, select the file to display the saved image by using any of the graph editing tools.

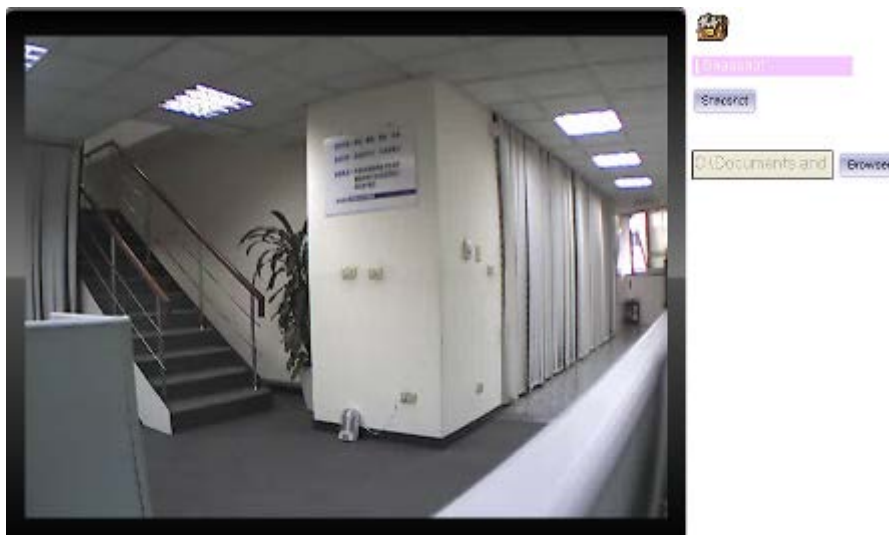

3.4.3 Record

Click **Record** to activate this function. Press the **Record** button to start recording. The video file is saved as ASF format onto your local PC. If you want to stop it, press **Stop** to stop

recording. Select **Browser** and a window pops up prompting you to select the save path and file name prefix, and select **OK** to continue.

After recording is stopped, list the files. This file is named as Video_yyyymmddhhmmss.avi .



3.4.4 Volume

Click Volume to activate this function. These have two control bars for speaker and microphone volume. Scroll this control bar to adjust the audio attribute. Check the volume mute to mute the speaker output.



3.4.5 About

Click **"About"** to show the ActiveX information

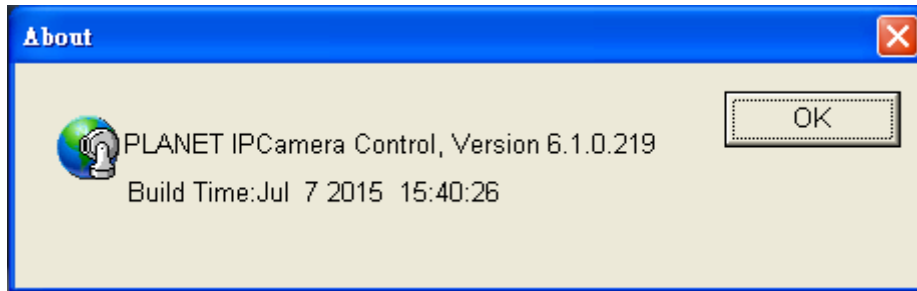

3.5 Network Configuration

Use this menu to configure the network to connect the device and the clients.

3.5.1 Network

This section provides the menu of connecting the device through Ethernet cable.

Network	IPv6	HTTPS	DDNS	PPPoE	Streaming	UPnP	Bonjour	IP Filter	IP Notification	QoS
MAC Address	00:30:4F:A3:58:EA									
<input checked="" type="checkbox"/> Obtain IP address automatically (DHCP)										
IP Address	192.168.0.11									Test
Subnet Mask	255.255.255.0									
Gateway	192.168.0.1									
<input checked="" type="checkbox"/> Obtain DNS from DHCP										
Primary DNS	192.168.0.1									
Secondary DNS	8.8.8.8									
HTTP Port	80									(1 ~ 65535) Test

MAC Address

Display the Ethernet MAC address of the device. Note that user cannot change it.

Obtain an IP address automatically (DHCP)

Enable this checked box when a DHCP server is installed on the network to issue IP address assignment. With this setting, the IP address is assigned automatically. If this device cannot get an IP address within limited tries, the device will assign a default IP

address for 192.168.0.20.

If you do not select “Obtain an IP address automatically”, then you need to enter these network parameters by yourself.

IP Address

This address is a unique numbers that identifies a computer or device on the WAN or LAN. These numbers are usually shown in groups separated by periods, for example, 192.168.0.200

Subnet Mask

Subnets allow network traffic between hosts to be separated based on the network's configuration. In IP networking, traffic takes the form of packets. IP subnets advance network security and performance to some level by organizing hosts into logical groups. Subnet masks contain four bytes and usually appear in the same "dotted decimal" data. For example, a very common subnet mask in its binary demonstration 11111111 11111111 11111111 00000000 will usually be shown in the corresponding, more readable form as 255.255.255.0.

Gateway

A gateway is a piece of software or hardware that passes information between networks. You'll see this term most often when you either log in to an Internet site or when your transient emails are transferring between different servers.

Obtain DNS from DHCP

Enable this checked box when a DHCP server is installed on the network and provide DNS service.

Primary DNS

When you send email or position a browser to an Internet domain such as xxxxx.com, the domain name system translates the names into IP addresses. The term refers to two things: the conventions for naming hosts and the way the names are controlled across the Internet.

Secondary DNS

The same function as DNS1. It is optional.

HTTP Port

The device supports two HTTP ports. The first one is default port 80 and this port is fixed. This port is very useful for Intranet usage. The second HTTP port is changeable. Users could assign the second port number of http protocol, and the WAN users should follow the port number to login. If the http port is not assigned as 80, users have to add the port number in the back of IP address. For example,

<http://192.168.0.20:8080>.

Therefore, the user can access the device by either

<http://xx.xx.xx.xx/>, or

<http://xx.xx.xx.xx:xxxx/> to access the device.

If multiple devices are installed on the LAN and also required to be accessed from the WAN, then the **HTTP Port** can be assigned as the virtual server port mapping to support multiple devices.



If you log in the camera as an ordinary user, setting function will be not available. If you log in the camera as an administrator, you can perform all the settings provided within the device.

When the configuration is finished, please click “**OK**” to save and enable the setting.

3.5.2 IPv6

Internet Protocol version 6 (IPv6) is called the “IP Next Generation” (IPng), which is designed to fix the shortcomings of IPv4, such as data security and maximum number of user addresses. It is backward compatible and thus expected to slowly replace IPv4.

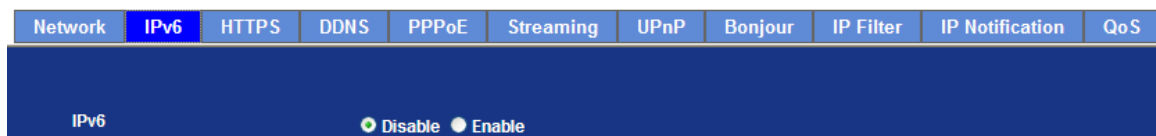

IPv6

To enable or disable the IPv6 function here.

3.5.3 HTTPS

HTTPS stands for Hypertext Transfer Protocol Secure

HTTPS is a combination of the Hypertext Transfer Protocol with the SSL/TLS protocol to provide encrypted communication and secure identification of a network web server. HTTPS connections are often used for sensitive transactions in corporate information systems. The main idea of HTTPS is to create a secure channel over an insecure network. This ensures reasonable protection from eavesdroppers and man-in-the-middle attacks, provided that

adequate cipher suites are used and that the server certificate is verified and trusted.

Network	IPv6	HTTPS	DDNS	PPPoE	Streaming	UPnP	Bonjour	IP Filter	IP Notification	QoS
<p>HTTPS <input checked="" type="radio"/> Disable <input type="radio"/> Enable</p> <p>Port <input type="text" value="443"/> (1 ~ 65535) <input type="button" value="Test"/></p>										

HTTPS

To enable or disable the HTTPS service here. Note that the HTTPS function of this device not only encrypts the web content but also audio/video data.

Port

Choose the HTTPS port. The default value is 443.

3.5.4 DDNS server

DDNS stands for Dynamic Domain Name Server

The device supports DDNS if your device is connected to xDSL directly. You might need this feature. However, if your device is behind a NAT router, you will not need to enable this feature. Because DDNS allows the device to use an easier way to remember naming format rather than an IP address. The name of the domain is like the name of a person, and the IP address is like his phone number. On the Internet we have IP numbers for each host (computer, server, router, and so on), and we replace these IP numbers to easily remember names, which are organized into the domain name. As to xDSL environment, most of the users will use dynamic IP addresses. If users want to set up a web or an FTP server, then the Dynamic Domain Name Server is necessary. For more DDNS configuration, please consult your dealer.

Your Internet Service Provider (ISP) provides with you at least one IP address which is used to connect to the Internet. The address you get may be static, meaning it never changes, or dynamic, meaning it's likely to change periodically. Just how often it changes, depending on your ISP. A dynamic IP address complicates remote access since you may not know what your current WAN IP address is when you want to access your network over the Internet. The solution to the dynamic IP address problem comes in the form of a dynamic DNS service.

The Internet uses DNS servers to look up domain names and translates them into IP addresses. Domain names are just easy to remember aliases for IP addresses. A dynamic DNS service is unique because it provides a means of updating your IP address so that your listing will remain current when your IP address changes. There are several excellent DDNS services available on the Internet and best of all they're free to use. One such service you can

use is www.planetddns.com. You'll need to register with the service and set up the domain name of your choice to begin using it. Please refer to the home page of the service for detailed instructions.

Network	IPv6	HTTPS	DDNS	PPPoE	Streaming	UPnP	Bonjour	IP Filter	IP Notification	QoS
<p>DDNS <input type="radio"/> Disable <input checked="" type="radio"/> Enable</p> <p>Server Name <input type="text" value="PLANET DDNS"/></p> <p>DDNS Host <input type="text" value="brandonw"/> .planetddns.com (6 ~ 16 Digits)</p> <p>User Name <input type="text" value="brandonw"/> (6~16 Digits)</p> <p>Password <input type="password" value="....."/> (6~16 Digits)</p> <p>Internet Status Connected (123.194.107.27)</p>										

DDNS To enable or disable the DDNS service here.

Server Name Choose the built-in DDNS server.

DDNS Host The domain name is applied for this device.

User Name The user name is used to log into DDNS.

Password The password is used to log into DDNS.

This model comes with Planet easy DDNS. When this function is enabled, DDNS hostname will appear automatically. User doesn't go to www.planetddns.com to apply for a new account.

Network	IPv6	HTTPS	DDNS	PPPoE	Streaming	UPnP	Bonjour	IP Filter	IP Notification	QoS
<p>DDNS <input type="radio"/> Disable <input checked="" type="radio"/> Enable</p> <p>Server Name <input type="text" value="PLANET Easy DDNS"/></p> <p>DDNS Host <input type="text" value="pla358ea.planetddns.com"/></p> <p>Internet Status Connected (123.194.107.27)</p>										

3.5.5 PPPoE

PPPoE stands for Point to Point Protocol over Ethernet

A standard builds on Ethernet and Point-to-Point network protocol. It allows Internet camera to connect to Internet with xDSL or cable connection; it can dial up your ISP and get a dynamic IP address. For more PPPoE and Internet configuration, please consult your ISP.

It can directly connect to the xDSL; however, it should be set up in a LAN environment to program the PPPoE information first, and then connect to the xDSL modem. Power it on again to enable device dial on to the ISP for connecting to the WAN through the xDSL modem.

The procedures are:

- Connect to a LAN by DHCP or Fixed IP
- Access the device by entering **Setting** → **Network** → **PPPoE** as shown below:

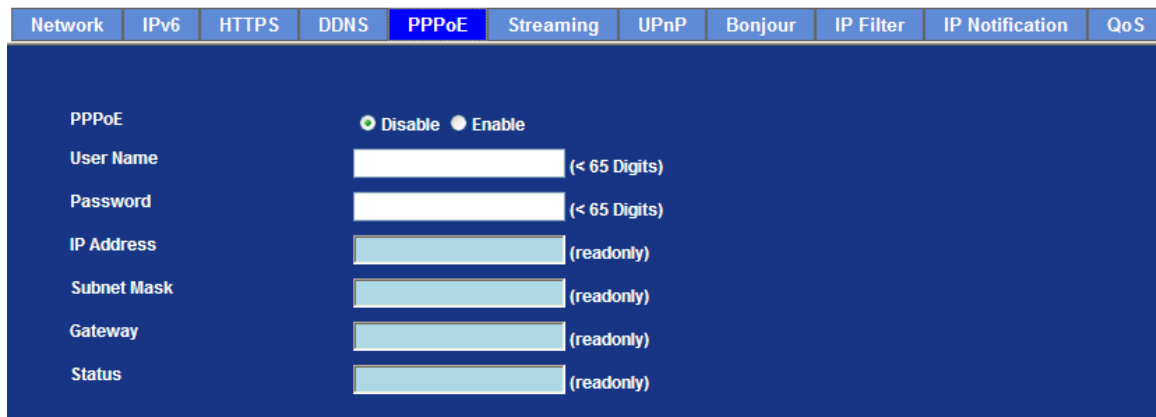

PPPoE To enable or disable the PPPoE service here.

User Name Type the user name for the PPPoE service which is provided by ISP.

Password Type the password for the PPPoE service which is provided by ISP.

IP Address/Subnet Mask/Gateway Shows the IP information got from PPPoE server site.

Status Shows the status of PPPoE connection.

3.5.6 Streaming

RTSP is a streaming control protocol, and a starting point for negotiating transports such as RTP, multicast and unicast, and for negotiating codes. RTSP can be considered a "remote control" for controlling the media stream delivered by a media server. RTSP servers typically use RTP as the protocol for the actual transport of audio/video data.

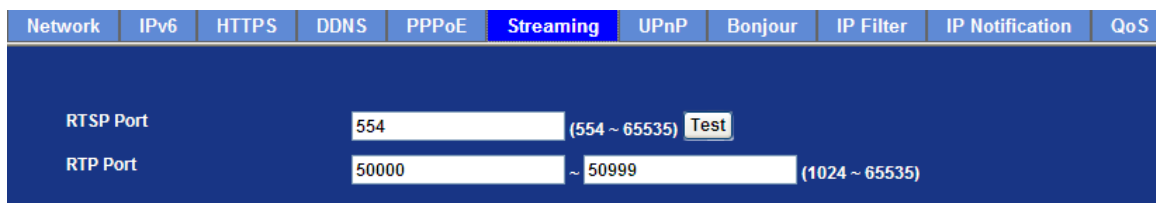

RTSP Port

Choose the RTSP port. The RTSP protocol allows a connecting client to start a video stream. Enter the RTSP port number to use. The default value is 554.

RTP Port

Specify the range of transmission port number of video stream. The default range is 50000 to 50999. User can specify a number between 1024 and 65535.



Note

1. To use the 3GPP function, in addition to the previous section, you might need more information or configuration to make this function work.
2. The camera must be set as multi-profile mode, not mega-pixel mode. Otherwise this device cannot serve 3GPP stream.
3. To use the 3GPP function, it is strongly recommended to install the Networked Device with a public and fixed IP address without any firewall protection.
4. Port 554 is the default for RTSP service. However, sometimes, some service providers change this port number for some reasons. If so, user needs to change this port accordingly.

Dialing procedure

1. Choose a verified player (PacketVideo, QuickTime or Real player)
2. Use the following URL to access: ***rtsp://host/mpeg4/media.3gp***
Where host is the host name or IP address of the camera.

Compatible 3G mobile phone

Please contact your dealer to get the approved list of compatible 3G phones.

3.5.7 UPnP

UPnP is short for Universal Plug and Play, which is a networking architecture that provides compatibility among networking equipment, software, and peripherals. This device is an UPnP enabled Internet camera. If your operating system is UPnP enabled, the device will automatically be detected and a new icon will be added to "My Network Places." If you do not want to use the UPnP functionality, it can be disabled.

In addition, this device also provides UPnP IGD function for NAT traversal easily. Use NAT traversal when your device is located on an intranet (LAN) and you wish to make it available

from the other (WAN) side of a NAT router. With NAT traversal properly configured, all HTTP traffic to an external HTTP port in the NAT router will be forwarded to the device.

Network	IPv6	HTTPS	DDNS	PPPoE	Streaming	UPnP	Bonjour	IP Filter
<p>UPnP <input type="radio"/> Disable <input checked="" type="radio"/> Enable</p> <p>Friendly Name <input type="text" value="IP camera - 00304F9DD066"/> (readonly)</p> <p>UPnP NAT Traversal <input type="radio"/> Disable <input checked="" type="radio"/> Enable</p> <p>Port Range <input type="text" value="32768"/> ~ <input type="text" value="65535"/> (1 ~ 65535)</p> <p>External IP Address <input type="text" value="AddPortMapping(32768, 32768, 192.168.1.205) failed with"/> (readonly)</p>								

UPnP To enable or disable the UPnP service here.

Friendly Name Shows the friendly name of this device here.

UPnP NAT Traversal When enabled, the device will attempt to configure port mapping in a NAT router on your network, using UPnP™. Note that UPnP™ must be enabled in the NAT router first.

Port Range The port range will open in NAT router.

External IP Address Shows the IP address and port for WAN access through Internet. If NAT traversal is configured successfully, user can use this IP address and port to access this device.

3.5.8 Bonjour

The Bonjour service allows IP camera to be discovered with Apple Safari browser applied. Once the option is enabled, the IP camera will show the Friendly Name in the Bonjour bookmarks menu of Safari browser.

Network	IPv6	HTTPS	DDNS	PPPoE	Streaming	UPnP	Bonjour	IP Filter
<p>Bonjour <input type="radio"/> Disable <input checked="" type="radio"/> Enable</p> <p>Friendly Name <input type="text" value="IP camera - 00304F9DD066"/> (readonly)</p>								

Bonjour To enable or disable the Bonjour service here.

Friendly Name Shows the friendly name of this device here.

3.5.9 IP Filter

You can enter different user's IP addresses by entering allow or deny.

The screenshot shows the IP Filter configuration page. At the top, there is a navigation bar with tabs for Network, IPv6, HTTPS, DDNS, PPPoE, Streaming, UPnP, Bonjour, IP Filter (selected), IP Notification, and QoS. The main content area has a dark blue background. It includes the following elements:

- IP Filter**: Disable Enable
- IP Filter Policy**: Deny Allow
- Save** button
- Filter IP List**: A table with one column labeled "Filter IP" and a text input field for each row. Below the table are **Add**, **Delete**, and **DeleteAll** buttons.

IP Filter To enable or disable the IP filter function here.

IP Filter Policy Choose the filter policy where deny or allow is.

3.5.10 Notification

In case the IP address is changed, system is able to send out an email to alert someone if the function is enabled.

Network	IPv6	HTTPS	DDNS	PPPoE	Streaming	UPnP	Bonjour	IP Filter	IP Notification	QoS
<p>SMTP Notification(email) <input checked="" type="radio"/> Disable <input type="radio"/> Enable</p> <p>Send To <input type="text"/> (< 129 Digits)</p> <p>Subject <input type="text" value="IP notification"/> (< 65 Digits)</p> <p>TCP Notification <input checked="" type="radio"/> Disable <input type="radio"/> Enable</p> <p>TCP Server <input type="text"/> (< 65 Digits)</p> <p>TCP Port <input type="text"/> (1 ~ 65535)</p> <p>Message <input type="text"/> (< 65 Digits)</p> <p>HTTP Notification <input checked="" type="radio"/> Disable <input type="radio"/> Enable</p> <p>URL <input type="text" value="http://"/> (< 61 Digits)</p> <p>HTTP Login Name <input type="text"/> (< 22 Digits)</p> <p>HTTP Login Password <input type="text"/> (< 22 Digits)</p> <p>Proxy Address <input type="text"/> (< 129 Digits)</p> <p>Proxy Port <input type="text"/> (1 ~ 65535)</p> <p>Proxy Login Name <input type="text"/> (< 22 Digits)</p> <p>Proxy Login Password <input type="text"/> (< 22 Digits)</p>										

SMTP Notification (e-mail)	If this function is enabled, the “Send to” and “Subject” field need to be filled out.
Send To	Type the receiver’s e-mail address. This address is used for reply mail.
Subject	Type the subject/title of the E-mail.
TCP Notification	If this function is enabled, the “TCP Server” , “TCP Port” , and “Message” fields need to be filled out.
TCP Server	Type the server name or the IP address of the TCP server.
TCP Port	Set port number of TCP server.
Message	The message will be sent to FTP server.

HTTP Notification	If this function is enabled, the fields below need to be filled out.
URL	Type the server name or the IP address of the HTTP server
HTTP Login Name	Type the user name for the HTTP server.
HTTP Login Password	Type the password for the HTTP server.
Proxy Address	Type the server name or the IP address of the HTTP Proxy.
Proxy Port	Set port number of Proxy.
Proxy Login Name	Type the user name for the HTTP Proxy.
Proxy Login Password	Type the password for the HTTP Proxy.
Custom Parameter	User can set specific parameters to HTTP server.
Message	The message will be sent to HTTP server.

3.5.11 CoS

IEEE 802.1P defines a QoS model at Layer 2 (L2, Data Link). This is called CoS (Class of Service), and adds an extra 3-bit field (called user-priority) to the VLAN MAC header.

Network	IPv6	HTTPS	DDNS	PPPoE	Streaming	UPnP	Bonjour	IP Filter	IP Notification	CoS	QoS	IEEE 802.1X
<p>CoS <input type="radio"/> Disable <input checked="" type="radio"/> Enable</p> <p>VLAN ID <input type="text" value="0"/> (0 ~ 4095)</p> <p>Live video <input type="text" value="0"/> (0 ~ 7)</p> <p>Live audio <input type="text" value="0"/> (0 ~ 7)</p> <p>Event/Alarm <input type="text" value="0"/> (0 ~ 7)</p> <p>Management <input type="text" value="0"/> (0 ~ 7)</p>												

CoS	To enable class of service (CoS) control for video/audio streams. If you enable this option, the IP camera specifies a VLAN tag that appends to an Ethernet MAC frame for video streaming data.
------------	--

VLAN ID	Enter the ID of the VLAN to which CoS packets are directed.
Live Video	Value from 0 (lowest priority) through 7 (highest priority) that specifies the CoS priority value for steaming video data.
Live Audio	Value from 0 (lowest priority) through 7 (highest priority) that specifies the CoS priority value for steaming audio data.
Event/Alarm	Value from 0 (lowest priority) through 7 (highest priority) that specifies the CoS priority value for event/alarm data.
Management	Value from 0 (lowest priority) through 7 (highest priority) that specifies the CoS priority value for management data.

3.5.12 QoS

This section describes how to set up the Differentiated Services Code Point (DSCP) values in Quality of Service (QoS) configurations. Differentiated Services (DiffServ) is a new model in which traffic is treated by intermediate systems with relative priorities based on the type of services (ToS) field. Defined in RFC2474 and RFC2475, the DiffServ standard supersedes the original specification for defining packet priority described in RFC791.

The DiffServ architecture defines the DiffServ (DS) field, which supersedes the ToS field in IPv4 to make per-hop behavior (PHB) decisions about packet classification and traffic conditioning functions, such as metering, marking, shaping, and policing.

The six most significant bits of the DiffServ field is called as the DSCP. Routers at the edge of the network classify packets and mark them with either the IP Precedence or DSCP value in a Diffserv network. Other network devices in the core that support Diffserv use the DSCP value in the IP header to select a PHB behavior for the packet and provide the appropriate QoS treatment.

DiffServ Field



- DSCP—six bits (DS5-DS0)
- ECN—two bits

The standardized DiffServ field of the packet is marked with a value so that the packet receives a particular forwarding treatment or PHB, at each network node.

The default DSCP is 000 000.

Network	IPv6	HTTPS	DDNS	PPPoE	Streaming	UPnP	Bonjour	IP Filter	IP Notification	CoS	QoS	IEEE 802.1X
<p>QoS <input type="radio"/> Disable <input checked="" type="radio"/> Enable</p> <p>Live Video DSCP <input type="text" value="0"/> (0 ~ 63)</p> <p>Live Audio DSCP <input type="text" value="0"/> (0 ~ 63)</p> <p>Event/Alarm DSCP <input type="text" value="0"/> (0 ~ 63)</p> <p>Management DSCP <input type="text" value="0"/> (0 ~ 63)</p>												

Live Video DSCP

Value from 0 (lowest priority) through 63 (highest priority) that specifies the DSCP priority value for steaming video data.

Live Audio DSCP

Value from 0 (lowest priority) through 63 (highest priority) that specifies the DSCP priority value for steaming audio data.

Live Event/Alarm DSCP

Value from 0 (lowest priority) through 63 (highest priority) that specifies the DSCP priority value for event/alarm data.

Live Management DSCP

Value from 0 (lowest priority) through 63 (highest priority) that specifies the DSCP priority value for management data.

3.5.13 IEEE 802.1X

IEEE 802.1X is an IEEE Standard for port-based Network Access Control. It is part of the IEEE 802.1 group of networking protocols. It provides an authentication mechanism for devices to connect to a LAN, either establishing a connection or preventing the connection if authentication fails. IEEE 802.1X prevents what is called “port hi-jacking”; that is, when an unauthorized computer gets access to a network by getting to a network jack inside or outside a building. In today’s enterprise networks, IEEE 802.1X is becoming a basic requirement for anything that is connected to a network.



IEEE 802.1X To enable or disable this function.

EAPOL version Select the EAPOL version (1 or 2) used in your network switch.

EAP Type Select either LEAP or TLS.

User Name Enter the user name associated with your certificate. A maximum of 16 characters can be used.

Password Enter the password (maximum 16 characters) for your user identity.

3.6 Camera Configuration

Use this menu to set the function of the camera of Internet camera.

3.6.1 Picture

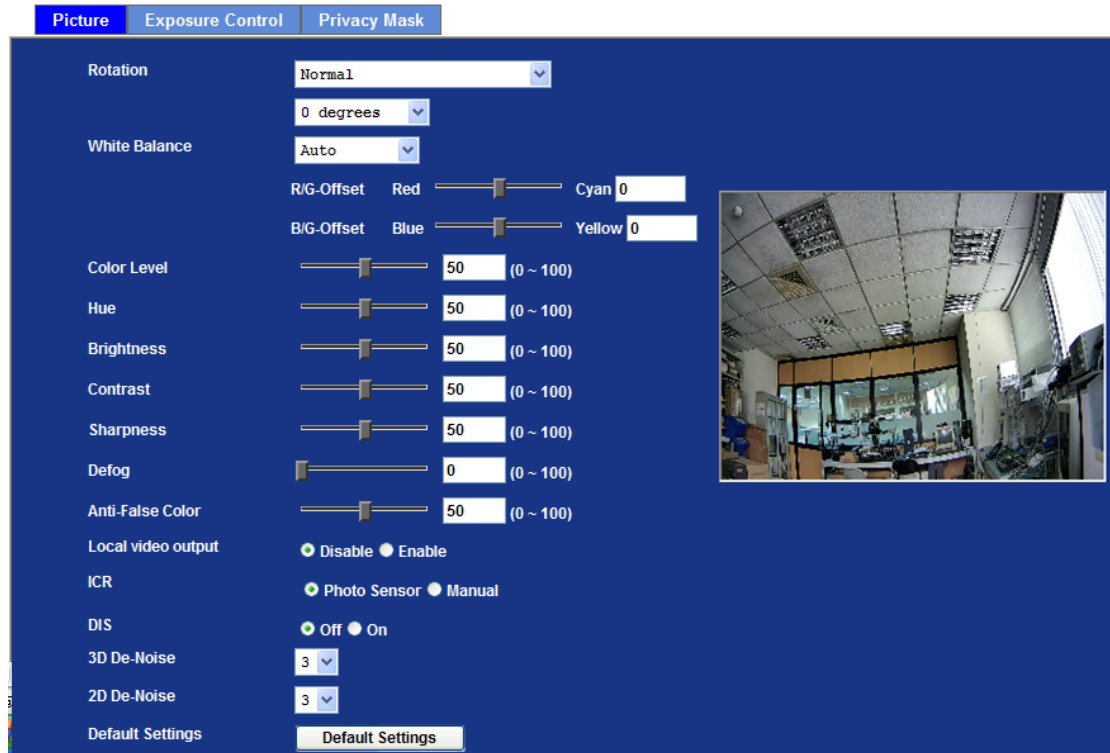

Turn the “**Mirror**” and “**Vertical Flip**” on or off. The image will be overturned as shown below.

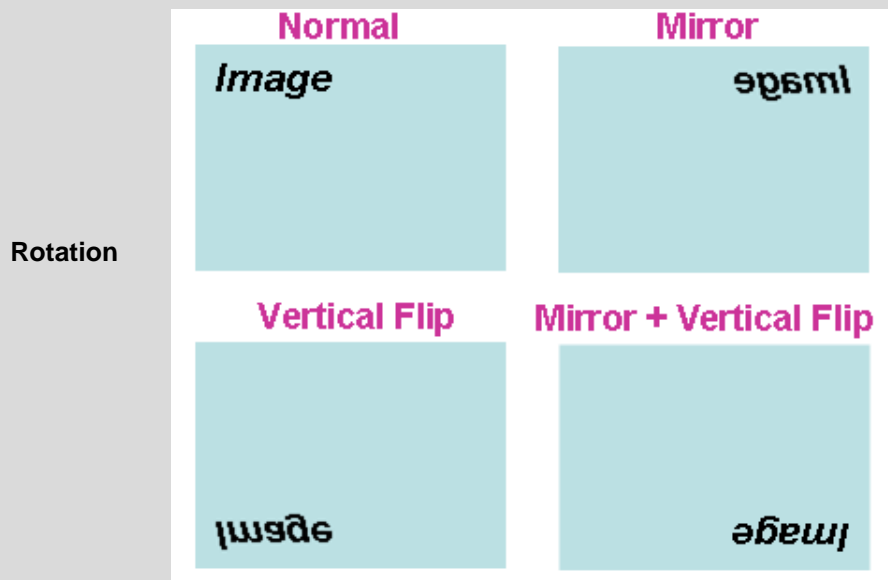

0/90 degrees The function allows you to get a vertically oriented video stream from the camera. Select “0” or “90” degrees to rotate image as shown below.

0 degree



90 degree

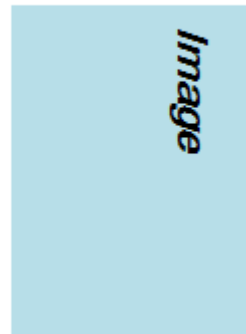

White Balance	Auto: will adjust the white balance automatically. Hold: will hold the white balance.
Color Level	Large value will be colorful.
Hue	Change the value by color tuning.
Brightness	Large value will brighten camera.
Contrast	Large value will contrast camera heavily.
Sharpness	Large value will sharpen camera.
Defog	Large value will try to de-fog image heavily.
Anti-False Color	Large value will try to lower the false color of image.
Local video output	Enable or disable video signal of BNC to a TV monitor. It's very useful to check view angle or focus during camera installation. However, disabling this function will save power a lot. Suggest disabling it after camera is installed.

Use built-in photo sensor or manual to control ICR.

ICR

In case user selects manual mode, there are 4 modes: Night (On), Day (Off), Auto or Schedule to control built-in IR LEDs. This function is very useful in a lowly-illuminated environment, even at 0 lux.

In case the Auto mode is selected, user needs to specify 3 parameters in advance:

Night Mode Threshold (0~10000): This value sets the threshold to turn on IR LED. It should be lower or equal to Day Mode Threshold.

Day Mode Threshold (0~10000): This value sets the threshold to turn off IR LED. It should be higher or equal to Night Mode Threshold.

Delay Time: The delay time between LED On/Off switching.

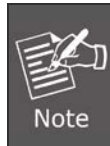

The Current Value is the current luminance from the captured video. It's a useful reference to set LED On/Off Threshold.

DIS (Digital Image Stabilization) is used to reduce blurring associated with the motion of a camera during exposure. Specifically, it compensates for pan and tilt of a camera. With video cameras, camera shake causes visible frame-to-frame jitter in the recorded video.

DIS

Real-time digital image stabilization is used to shift the electronic image from frame to frame of video, enough to counteract the motion. This technique reduces distracting vibrations from videos or improves still image quality by allowing one to increase the exposure time without blurring the image. This technique does not affect the noise level of the image.

**2D/3D
De-Noise**

Select the Digital Noise Reduction option. Digital noise reduction value reduces noise on the video (especially in low light) which makes the image look smoother and clearer.

**Default
Settings**

Restore to factory image settings.

3.6.2 Exposure Control



Power Frequency	Frequency of power line: 50 or 60Hz.
Exposure Control	<p>Auto: It will adjust the image sensor exposure automatically as possible.</p> <p>Hold: The current exposure value will be fixed.</p> <p>Manual Exposure: User can configure sensor exposure to fixed setting.</p>
Maximum Exposure Time	Set the Maximum Exposure Time. However, the real exposure time may be shorter if it is under good light condition.
Exposure Value	Exposure value is AE target value. This value is to adjust the integration, analog gain and digital gain to achieve the target brightness value (Exposure Value).
Iris	Enable or disable built-in P-Iris control.
BLC	Enable or disable BLC (back light compensation) function.
WDR	<p>Digital WDR: It is effective at the complex in strong backlight and light, clear images without distortion. The recommended application is garage, where the junction of light and dark is.</p> <p>True WDR: Much effective than D-WDR, true WDR is great for tunnels where license plates, etc. can be recognized.</p>

3.6.3 Privacy Mask

Use this page to specify privacy mask window 1 to window 7 and set the name and gray level for selected window.

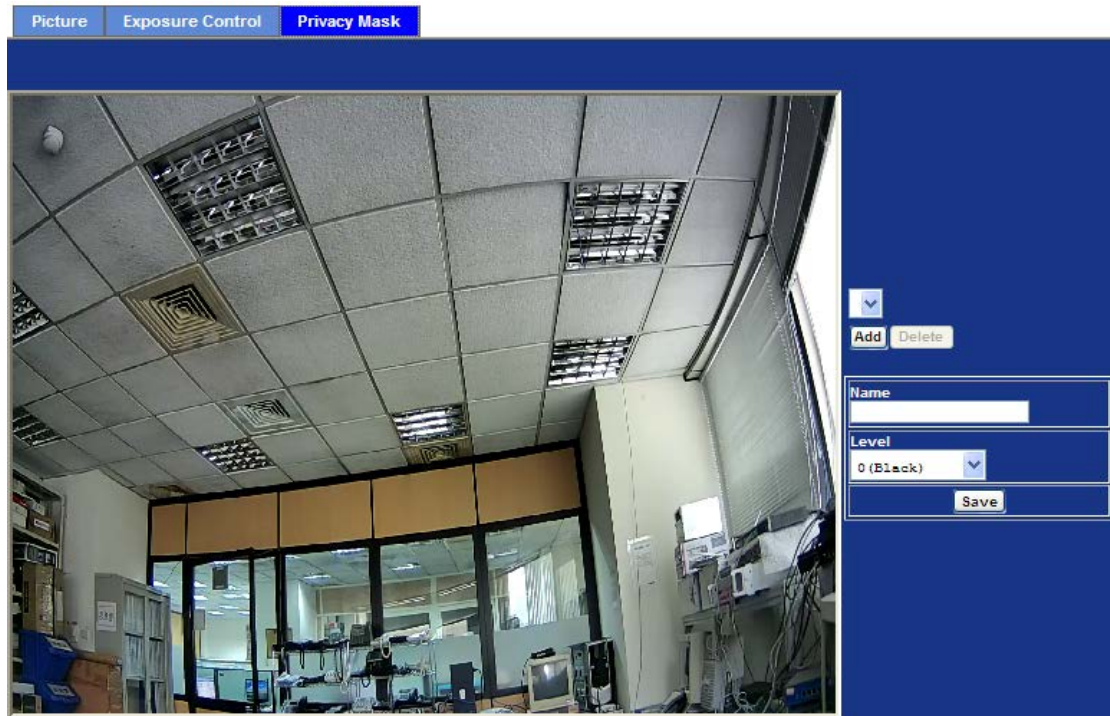

Add and Delete

To add or delete the privacy mask windows, user can specify up to 7 windows to mask the video captured by this device. By dragging mouse on the image, you can change the position and size of the selected window accordingly.

Name Name of the specified privacy window

Level To define the gray level of mask block. The smaller value will be darker.

3.7 Focus

Use this menu to set the focus of camera.

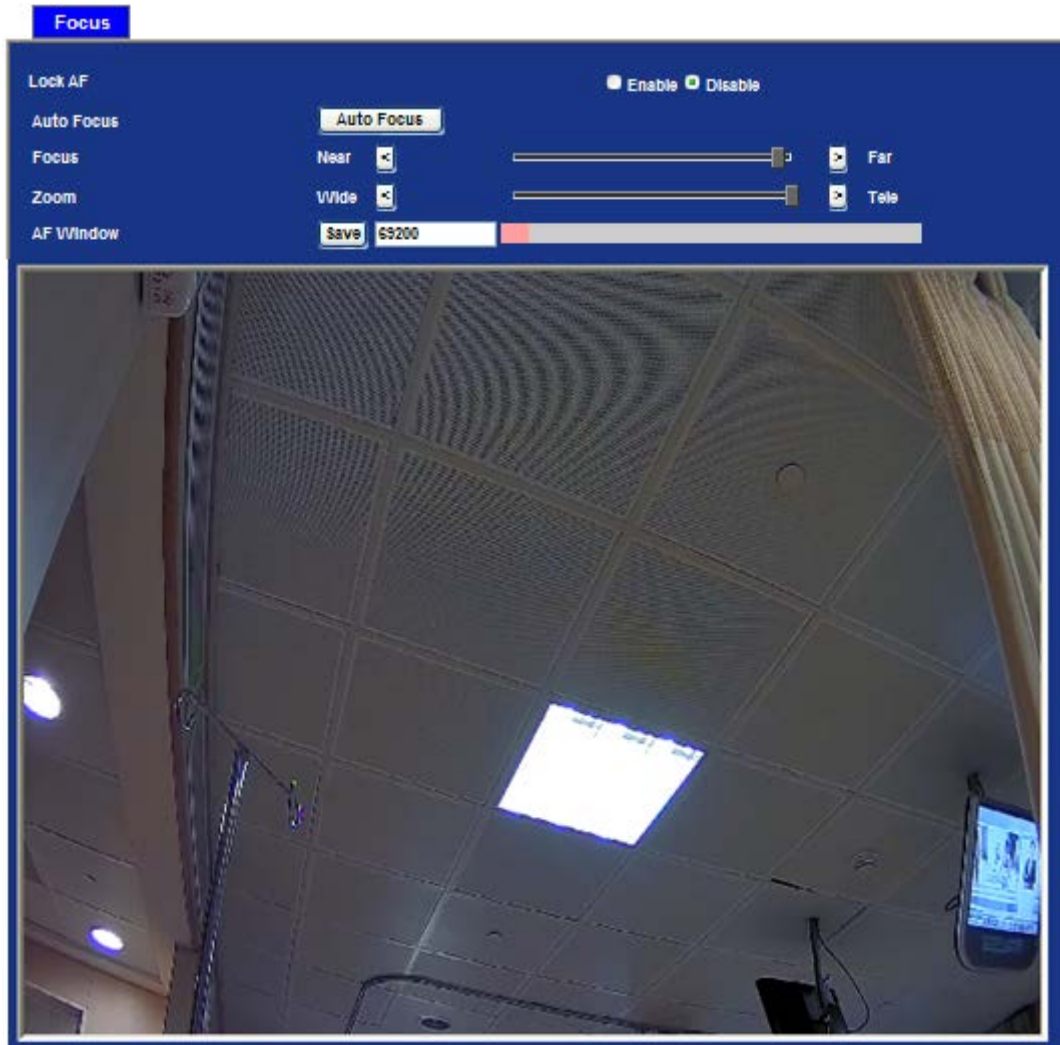

Lock AF If the function is enabled, the current focus of camera is fixed.

Auto Focus Click this button to activate push AF.

Focus Adjust focus manually.

Zoom Adjust zoom manually.

3.8 System Configuration

Use this menu to perform the principal settings of Internet Camera.

3.8.1 System

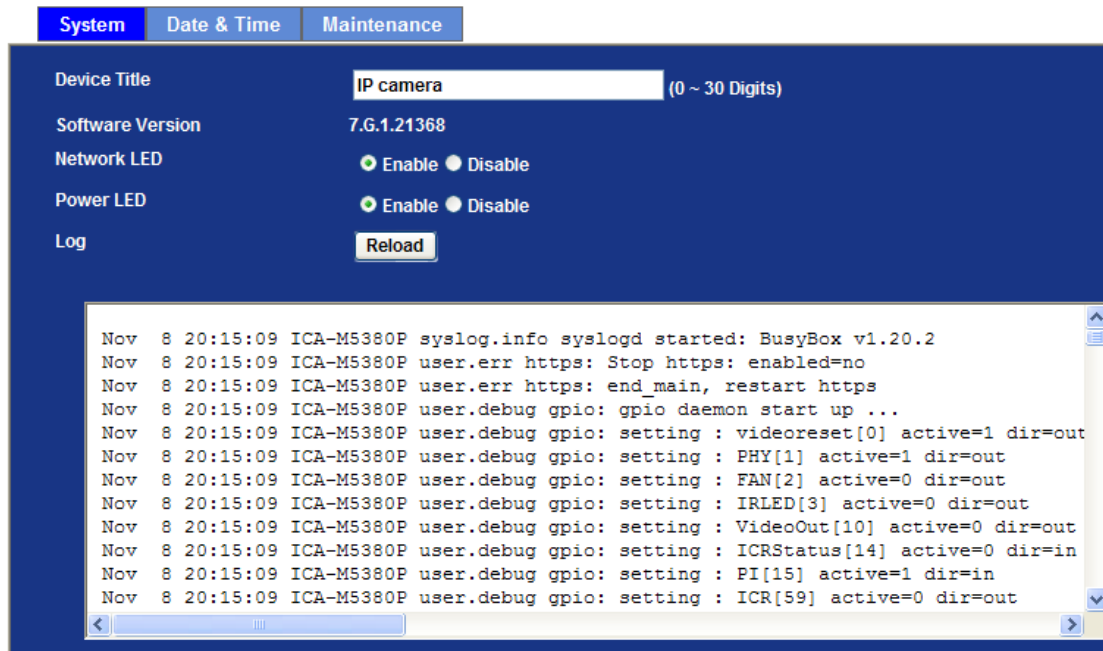

The screenshot shows the 'System' configuration page. At the top, there are three tabs: 'System', 'Date & Time', and 'Maintenance'. Below the tabs, the 'Device Title' is set to 'IP camera' with a note '(0 ~ 30 Digits)'. The 'Software Version' is '7.G.1.21368'. There are two radio button options: 'Network LED' (Enable/Disable) and 'Power LED' (Enable/Disable). Below these is a 'Log' section with a 'Reload' button. A log window is open, displaying the following text:

```
Nov 8 20:15:09 ICA-M5380P syslog.info syslogd started: BusyBox v1.20.2
Nov 8 20:15:09 ICA-M5380P user.err https: Stop https: enabled=no
Nov 8 20:15:09 ICA-M5380P user.err https: end_main, restart https
Nov 8 20:15:09 ICA-M5380P user.debug gpio: gpio daemon start up ...
Nov 8 20:15:09 ICA-M5380P user.debug gpio: setting : videoreset[0] active=1 dir=out
Nov 8 20:15:09 ICA-M5380P user.debug gpio: setting : PHY[1] active=1 dir=out
Nov 8 20:15:09 ICA-M5380P user.debug gpio: setting : FAN[2] active=0 dir=out
Nov 8 20:15:09 ICA-M5380P user.debug gpio: setting : IRLED[3] active=0 dir=out
Nov 8 20:15:09 ICA-M5380P user.debug gpio: setting : VideoOut[10] active=0 dir=out
Nov 8 20:15:09 ICA-M5380P user.debug gpio: setting : ICRStatus[14] active=0 dir=in
Nov 8 20:15:09 ICA-M5380P user.debug gpio: setting : PI[15] active=1 dir=in
Nov 8 20:15:09 ICA-M5380P user.debug gpio: setting : ICR[59] active=0 dir=out
```

Device Title You can enter the name of this unit here. It's very useful to identify the specific device from multiple units.

Software version This information shows the software version in the device.

Network LED Switch the LED light of the camera on or off, so that Network LEDs will stop working; in case you don't want other people to know the camera is transferring data.

Power LED Switch the power LED light of the camera on or off.

Log User can check the system log information of the device, including the Main Info, Appended Info, Operator IP, and so on.

Reload Click this button; user can refresh the log information of the device.

3.8.2 Date & Time

User can set up the time setting of Internet camera. Synchronize it with PC or remote NTP server. Also, you may select the correct time zone of your country.



Server Date & Time Displays the date and time of the device.

PC Time Displays the date and time of the connected PC.

Adjust	Synchronize with PC:	Click this option to enable time synchronization with PC time.
	Manual Setting:	Click this option to set time and date manually.
	Synchronize with NTP:	Click this option if you want to synchronize the device's date and time with those of time server called NTP server (Network Time Protocol).

NTP Server Name Type the host name or IP address or domain name of the NTP server.

NTP Sync. Interval	Select an interval between 1 and 23 hours at which you want to adjust the device's time referring to NTP server.
Time Zone	Set the time difference from Greenwich Mean Time in the area where the device is installed.
Daylight Saving	Check this item to enable daylight saving adjustment.
Daylight Saving Start Time	Set up the date and time of daylight saving start time.
Daylight Saving Stop Time	Set up the date and time of daylight saving stop time.
Daylight Saving Offset	Set up the date of daylight saving offset.

3.8.3 Maintenance

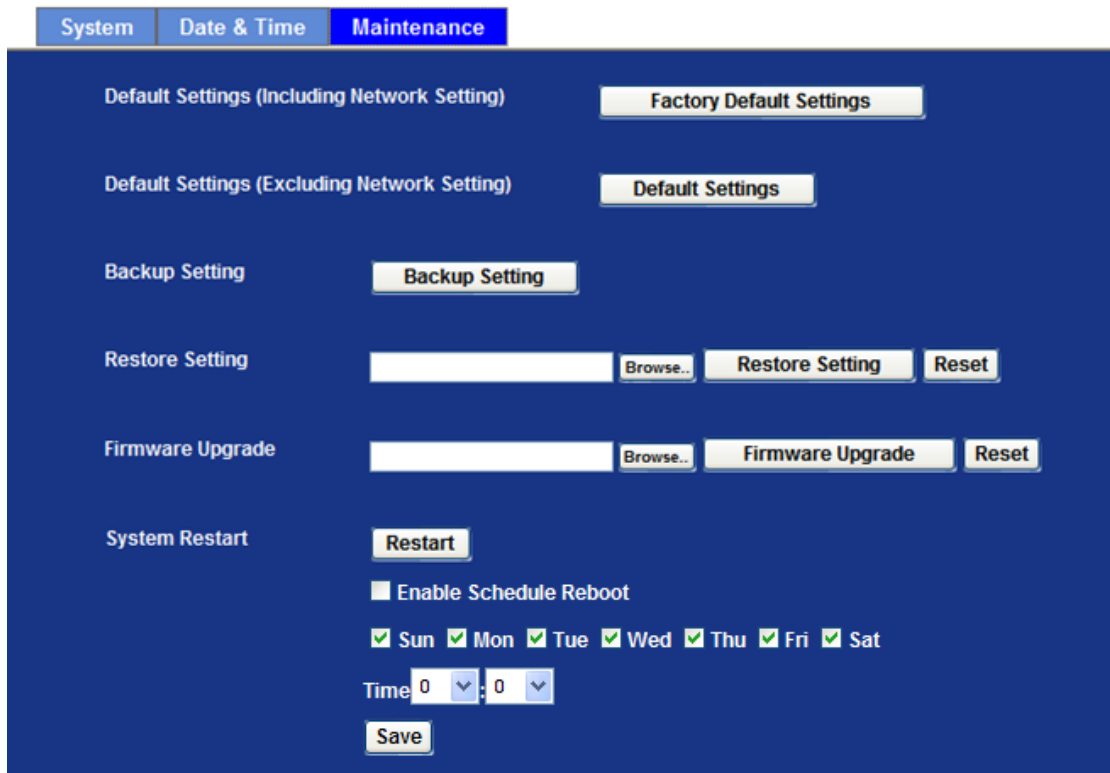

System | Date & Time | **Maintenance**

Default Settings (Including Network Setting) Factory Default Settings

Default Settings (Excluding Network Setting) Default Settings

Backup Setting Backup Setting

Restore Setting Browse... Restore Setting Reset

Firmware Upgrade Browse... Firmware Upgrade Reset

System Restart Restart

Enable Schedule Reboot

Sun Mon Tue Wed Thu Fri Sat

Time :

Save

Default Settings (Including the network setting)

Recall the device hard factory default settings. Note that clicking this button will reset all devices' parameters to the factory settings (including the IP address).

Default Settings (Except the network setting)

The unit is restarted and most current settings are reset to factory default values. This action will not reset the network setting.

Backup Setting

To take a backup of all of the parameters, click this button. If necessary, it will then be possible to return to the previous settings if settings are changed and there is unexpected behavior.

Restore Setting

Click the "Browse" button to locate the saved backup file and then click the "Restore Setting" button. The settings will be restored to the previous configuration.

Firmware Upgrade

The device supports new firmware upgrade.

1. Close all other application programs which are not necessary for firmware update.
2. Make sure that only you access this device at this moment
3. Disable Motion Detection function.
4. Select "**Firmware name**"
5. Select the Firmware binary file.



Note

Make sure that the Firmware only applies to this device; once updated, it will be burned into FLASH ROM of system.

6. Once the firmware file is selected, select "Upgrade".
7. The upgrade progress information will be displayed on the screen.
8. A message will be shown while the firmware is upgraded. Once the upgrading process is

completed, the device will reboot the system automatically.

9. Please wait for 80 seconds, and then you can use PLANET IPWizard II to search the device again.

Warning!!! The downloading firmware procedure cannot be interrupted. If the power and/or network connection are/is broken during the download procedure, it might possibly cause serious damage to the device.

Please be aware that you should not turn off the power during updating the firmware and waiting for the “finish” message. Furthermore, do not try to upgrade new firmware if necessary.

System Restart

The device is restarted without changing any of the settings.

Enable Schedule Reboot

The device will reboot automatically according to the schedule. Please make sure the **Date & Time** setting is correct when this function is enabled.

3.9 Video Configuration

3.9.1 Common

Common	Overlay Image	Video Profile	ONVIF Profile	ROI	AOI	Pixel Counter
Text Overlay Setting						
Font Color	000000	Set Color	Default Color			
Background Color	787878	Set Color	Default Color			
Transparency	0 (opacity)	▼				
Position	Align Top Left	▼				
<input type="checkbox"/> Include Date						
	Predefined	YYYY-MM-DD	▼			
	Own	%Y-%m-%d	(0 ~ 12 Digits)			
<input type="checkbox"/> Include Time						
	Predefined	24h	▼			
	Own	%H:%M:%S	(0 ~ 12 Digits)			
<input type="checkbox"/> Include Text						
			(0 ~ 20 Digits)			

Text Overlay Setting

There are some important information that can be embedded into image, including date, time, and/or text.

3.9.2 Overlay Image

User can upload bitmap file to the camera and overlay the picture on streaming video and set its attributes.

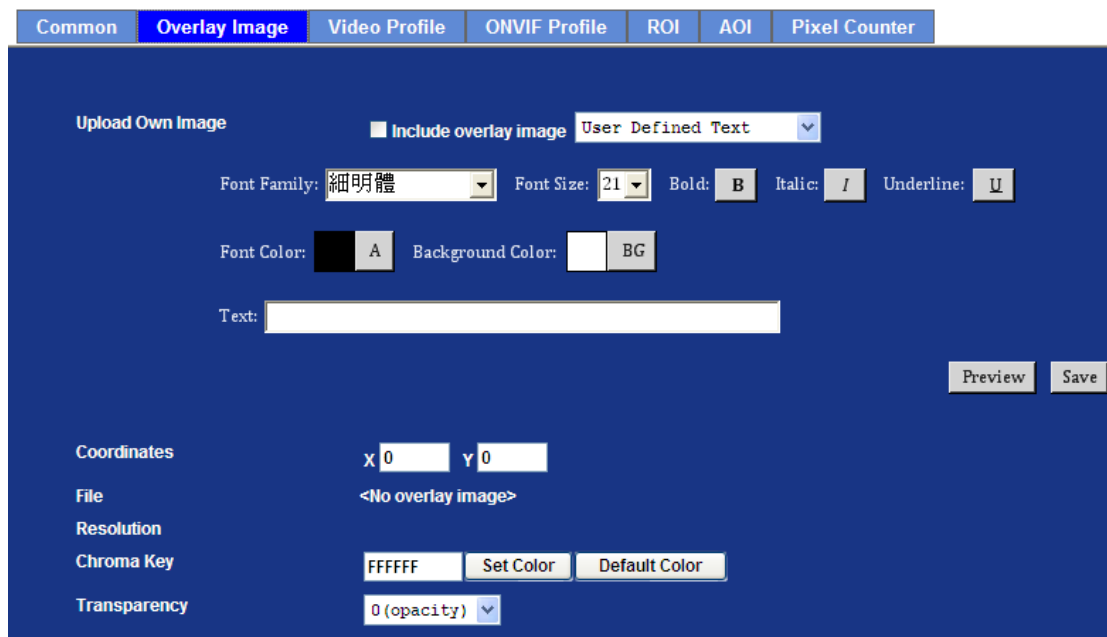

Upload Own Image

There are two options: “Image Overlay Setting” or “User Defined Text”.

Image Overlay Setting

Check this item to enable image overlay. Otherwise, the uploaded bitmap will not be overlaid on video.

Coordinates

Set position of image on the video.

File

Information of the uploaded bitmap file.

Resolution

Size information of the uploaded bitmap file.

Chroma Key (Background Color)

Define the Chroma key of the uploaded bitmap file. Then user can set transparency of the bitmap.

Transparency Lower value will lower transparency. Value 0 means opacity.

3.9.3 Video Profile

User can modify the detailed parameter for each video profile on this page.

Common	Overlay Image	Video Profile	ONVIF Profile	ROI	AOI	Pixel Counter			
Name	Video Type	Resolution	Rate Control	Quality	Bitrate	Max Frame Rate	GOP Control	ROI	Multicast
Profile1	h265	2048x1536	CBR	-	5000	30	30	no	no
Profile2	h264/Baseline	640x480	CBR	-	1000	30	30	no	no
Name	Profile1								
Video Type	h265								
Resolution	2048x1536								
ROI	<input checked="" type="radio"/> Yes <input checked="" type="radio"/> No								
Rate Control	CBR Bitrate 5000 K bps 1024 ~ 20000								
Max Frame Rate	30								
GOP Control	30								
Multicast	<input checked="" type="radio"/> Enable <input checked="" type="radio"/> Disable								
Multicast Video	IP Address 239.198.97.181 Port 0 (0 means auto, 1024 ~ 65534)								
Multicast Audio	IP Address 239.198.97.181 Port 0 (0 means auto, 1024 ~ 65534)								
Time to live	1 (1 ~ 255)								
Always Enable Multicast	<input checked="" type="radio"/> Enable <input checked="" type="radio"/> Disable								

Name To assign a name to the selected profile.

Video Type Video codec of the selected profile.

Resolution Resolution of the selected profile.

ROI Assign the selected profile as a ROI stream or not. (Only available for the profiles with higher resolutions)

Rate Control Defines the rate control method of this profile. There are three options: Constant Bit Rate (CBR), Variable Bit Rate (VBR), and Enhanced Variable Bit Rate (EVBR).

For CBR, the video bit rate is between low and high bandwidth based on different resolutions. User can set the desired bit rate to match the limitation of bandwidth.

For VBR, user should choose the quality level to set the video quality rather than bit rate. The quality level is between 1 and 100. The

	<p>higher value can reach the better quality but of course will consume higher bandwidth.</p> <p>For EVBR, the video bitrate is based on normal VBR mode. However, the bitrate can be limited to the max. Bitrate while there are lots of motions in video.</p>
Max. Frame Rate	<p>Defines the targeted frame rate of this profile. For example, set the frame rate to 15 fps, then the image will be updated for 15 frames per second. User can set the desired max. Frame rate versus video quality under the limited bandwidth.</p>
GOP Control	<p>Defines the Intra/Inter-frame (I/P) ratio of this profile. For example, set the GOP to 30, then the video stream will have one Intra-frame every 30 frames.</p> <p>It is recommended set the value the same as Max. Frame Rate.</p>
Multicast	<p>Enable or disable the multicast function.</p>
Multicast Video	<p>IP address and port for multicast video streaming of the selected profile.</p>
Multicast Audio	<p>IP address and port for multicast audio streaming of the selected profile</p>
Time to live	<p>Time to live (TTL) is a mechanism that limits the lifespan of data in a computer or network. Once the prescribed event count or timespan has elapsed, data is discarded. TTL prevents a data packet from circulating indefinitely.</p>
Always Enable Multicast	<p>Multicast streaming is always enabled or by request</p>

Warning!!!

To enable the multicast streaming, make sure your Intranet does support multicast function. Otherwise, your Intranet may fall into network storm seriously.

3.9.4 ONVIF Profile

ONVIF protocol defines profile of video streams. In case, the NVR, CMS and/or VMS connect to this device via ONVIF protocol. Use this page to define parameters of video streams.

Common		Overlay Image		Video Profile		ONVIF Profile		ROI		AOI		Pixel Counter	
Name	Video Type	Resolution	Quality	Max Bitrate	Max Frame Rate	GOP Control	Audio						
OnvifProfile1	h264/Baseline	2048x1536	90	5000	30	30	no						
OnvifProfile2	h264/Baseline	640x480	90	1000	30	30	no						

Name	OnvifProfile1
Video Type	h264 Baseline
Resolution	2048x1536
Rate Control	Quality 90 Max Bitrate 5000 K bps 1024 - 20000
Max Frame Rate	30
GOP Control	30
Audio	<input checked="" type="radio"/> Enable <input type="radio"/> Disable
Multicast Video	IP Address 239.198.97.181 Port 0 (0 means auto, 1024 ~ 65534)
Multicast Audio	IP Address 239.198.97.181 Port 0 (0 means auto, 1024 ~ 65534)
Time to live	1 (1 ~ 255)

Name To assign a name to the selected profile.

Video Type Video codec of the selected profile.

Resolution Resolution of the selected profile.

Defines the rate control method of this profile. It supports Enhanced Variable Bit Rate (EVBR).

Rate Control For EVBR, the video bitrate is based on normal VBR mode. However, the bitrate can be limited to the max. Bitrate while there are lots of motions in video.

Max. Frame Rate Defines the targeted frame rate of this profile. For example, set the frame rate to 15 fps, then the image will be updated for 15 frames per second. User can set the desired max frame rate versus video quality under the limited bandwidth.

GOP Control Defines the Intra/Inter-frame (I/P) ratio of this profile. For example, set the GOP to 30, then the video stream will have one Intra-frame

every 30 frames.

It is recommended set the value the same as **Max. Frame Rate**.

Audio

Enable or disable the audio function.

Multicast Video

IP address and port for multicast video streaming of the selected profile.

Multicast Audio

IP address and port for multicast audio streaming of the selected profile

Time to live

Time to live (TTL) is a mechanism that limits the lifespan of data in a computer or network. Once the prescribed event count or timespan has elapsed, data is discarded. TTL prevents a data packet from circulating indefinitely.

Warning!!!

To enable the multicast streaming, make sure your Intranet does support multicast function. Otherwise, your Intranet may fall into network storm seriously.

3.9.5 ROI

ROI means Region of Interest. Use this page to specify location and size of ROI windows. Only the maximum resolution profiles can be defined as ROI. In this model, user can define maximum three ROI windows.

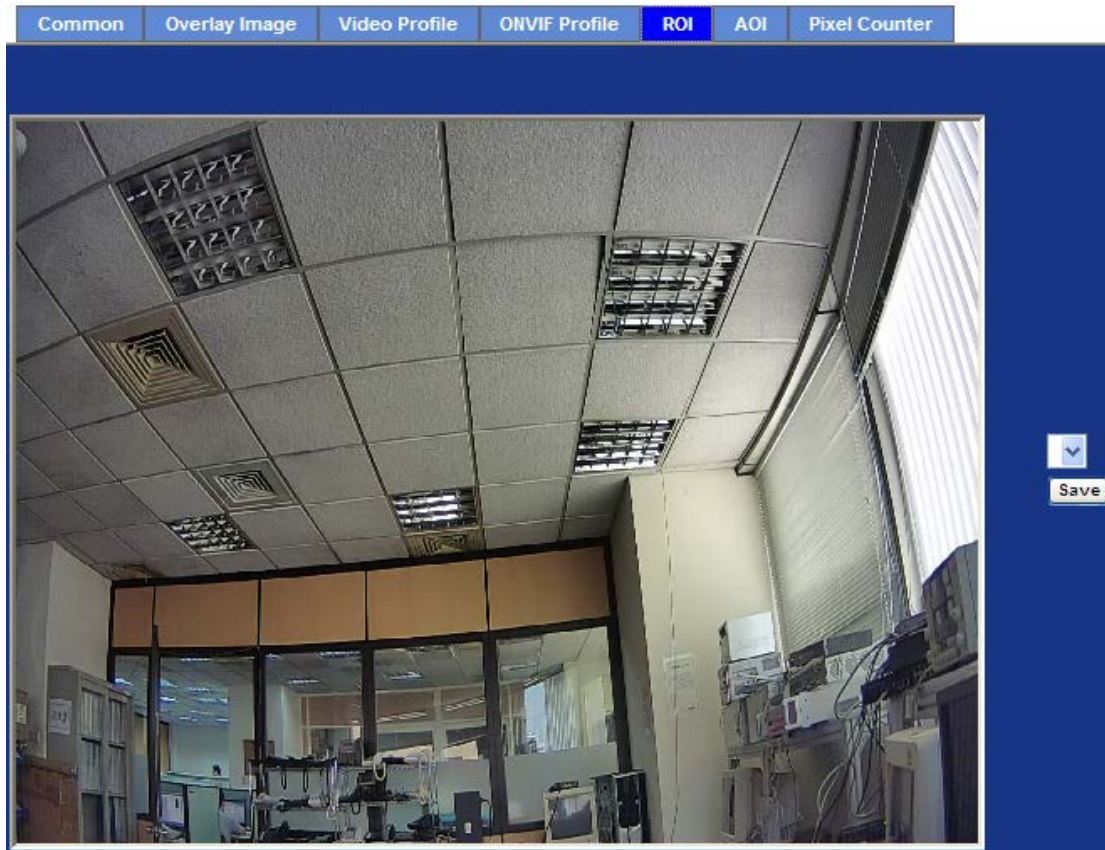

Please enable the ROI function on the page of video profile first.

3.9.6 AOI

AOI means Area of Interest. Use this page to specify location and size of AOI windows. Only the profiles with H.264 codec and VBR rate control can support AOI function. It enables a non-uniform distribution of the image quality between a selected region (the AOI) and the rest of the image (background).

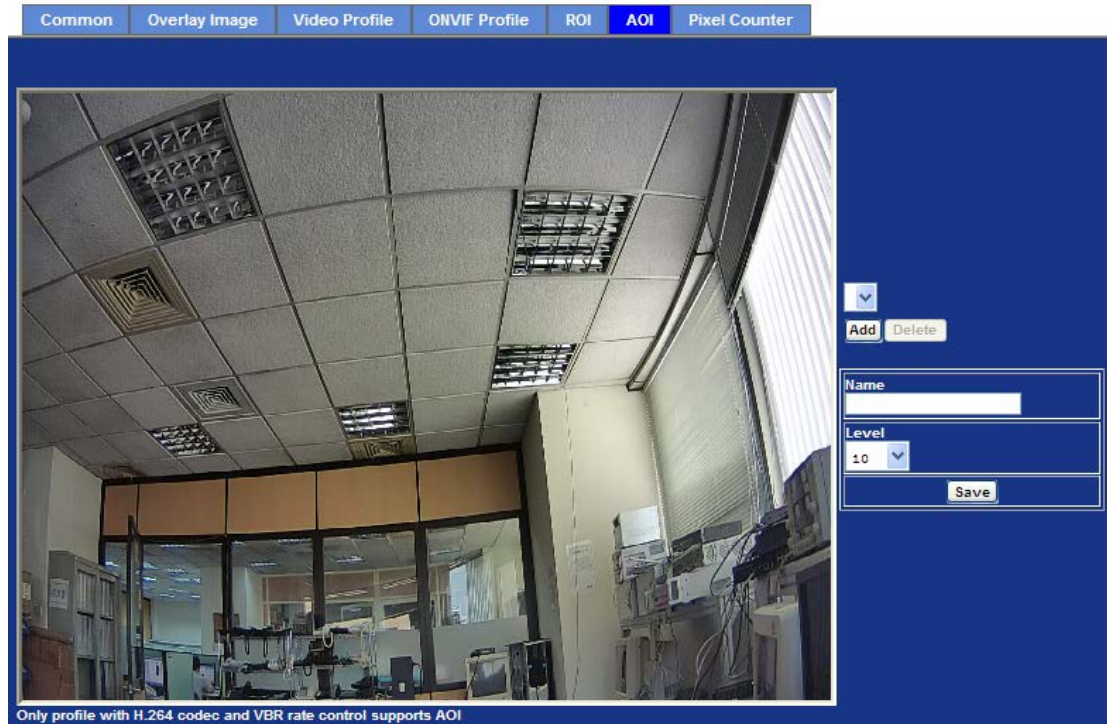

Add and Del

To add or delete the AOI windows. User can specify up to 2 AOI windows to change the video quality in specified areas. By dragging mouse on the image, you can change the position and size of the selected AOI window accordingly

Name Name of the specified AOI window.

Level Adjust the video quality of specified AOI window. The higher value will be better for video quality.

3.9.7 Pixel Counter

The pixel counter shows the number of pixels in an area of the image. The pixel counter is useful in situations where there is a requirement that the image is a certain size, for example in face recognition.



3.10 Audio Configuration

3.10.1 Setting

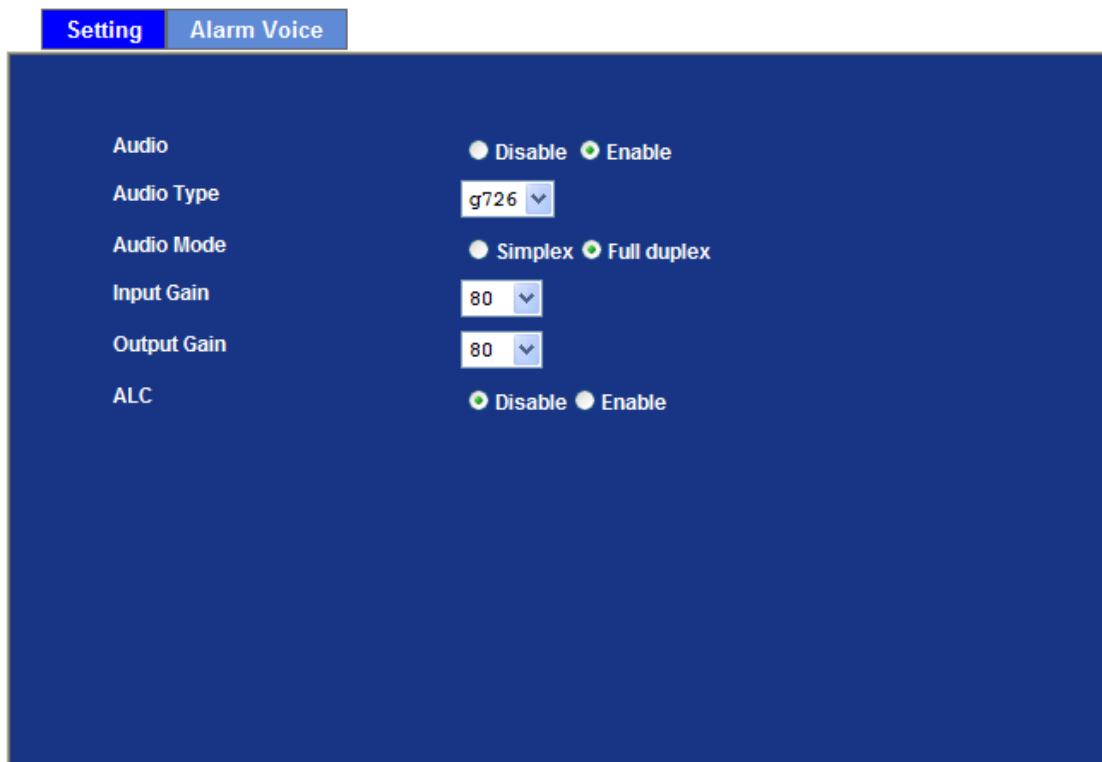

Audio	To enable or disable audio function.
Audio Type	To select G711 or G726 for audio coding.
Audio Mode	To select Simplex or Full duplex (2-way audio) mode.
Input Gain	To adjust gain of input audio.
Output Gain	To adjust gain of output audio.
ALC	Enabled ALC (automatic level control) function can help eliminate the audio volume problem posed by small speakers.

3.10.2 Alarm Voice

User can upload preferred voice file to Camera for alarm message instead of system default.

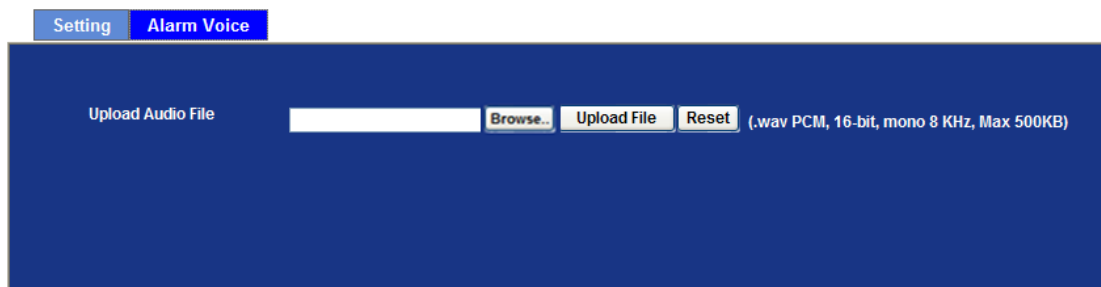

Setting Alarm Voice

Upload Audio File Browse.. Upload File Reset (.wav PCM, 16-bit, mono 8 KHz, Max 500KB)

3.11 User Configuration

Use this menu to set the user names and password of the Administrator and up to 10 users, and access right of each user.

Setting

Viewer Login Anonymous Only users in database **Save**

User Name	Access Right	User List	
admin	administrator	User Name	<input type="text"/> (1 ~ 20 Digits)
		Password	<input type="text"/> (0 ~ 20 Digits)
		Verify Password	<input type="text"/> (0 ~ 20 Digits)
		Access Right	<input checked="" type="radio"/> Administrator <input type="radio"/> Viewer
		Add Modify Delete	

Viewer Login

Select “Anonymous” to allow any one viewing the video once connected. Otherwise, only users in database can view the video after login.

Access Right

Administrator can access every function in this device. However, Viewers only can view the video and access limited function.

Add, update, and remove of Users account

Manage the user’s account of viewer user.

3.12 Protocol Configuration

3.12.1 ONVIF

ONVIF is a global and open industry forum with the goal to facilitate the development and use of a global open standard for the interface of physical IP-based security products. In other words, it creates a standard for how IP products within video surveillance and other physical security areas can communicate with each other.

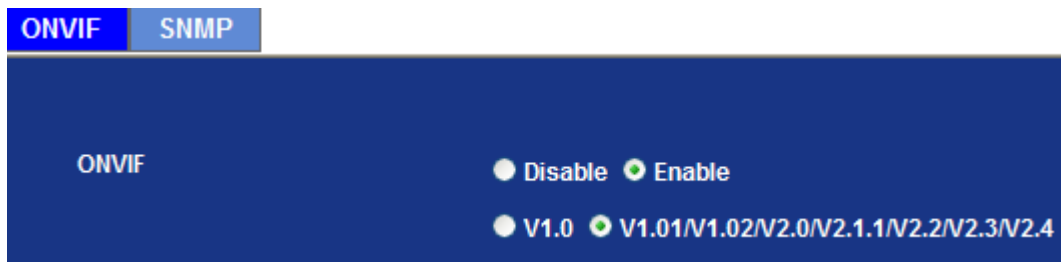

3.12.2 SNMP

Simple Network Management Protocol (SNMP) is an "Internet-standard protocol for managing devices on IP networks". Devices that typically support SNMP include routers, switches, servers, workstations, printers, and more. It is used mostly in network management systems to monitor network-attached devices for conditions that warrant administrative attention.

SNMP is a component of the Internet Protocol Suite as defined by the Internet Engineering Task Force (IETF). It consists of a set of standards for network management, including an application layer protocol, a database schema, and a set of data objects. SNMP exposes management data in the form of variables on the managed systems, which describe the system configuration. These variables can then be queried (and sometimes set) by managing applications.



SNMP version 1 (SNMPv1) is the initial implementation of the SNMP protocol. SNMPv1

operates over protocols such as User Datagram Protocol (UDP), Internet Protocol (IP), OSI Connectionless Network Service (CLNS), AppleTalk Datagram-Delivery Protocol (DDP), and Novell Internet Packet Exchange (IPX). SNMPv1 is widely used and is the de facto network-management protocol in the Internet community

SNMPv2c is defined in RFC 1901–RFC 1908. In its initial stages, this was also informally known as *SNMPv1.5*. SNMPv2c comprises SNMPv2 *without* the controversial new SNMP v2 security model, using instead the simple community-based security scheme of SNMPv1. While officially only a "Draft Standard", this is widely considered the *de facto* SNMPv2 standard.

3.13 E-mail Configuration

User may set up SMTP mail parameters for further operation of Event Schedule. If users want to send the alarm message out, it will need to configure parameters here and also add at least one event schedule to enable event triggering.

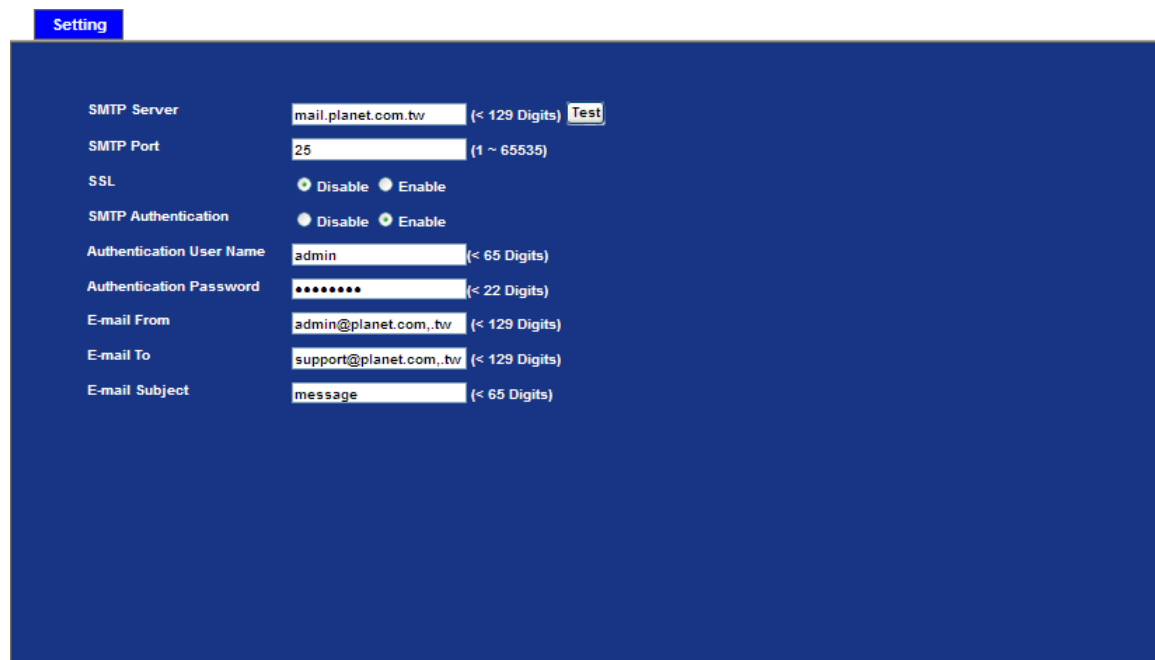

SMTP Server

Type the SMTP server name or the IP address of the SMTP server.

Test

Send a test mail to mail server to check whether this account is available or not.

SMTP Port

Set port number of SMTP service.

SSL	Enable SSL function or not.
SMTP Authentication	Select the authentication required when you send an e-mail. Disable: If no authentication is required when an e-mail is sent. Enable: If authentication is required when an e-mail is sent.
Authentication User Name	Type the user name for the SMTP server if Authentication is Enabled.
Authentication Password	Type the password for the SMTP server if Authentication is Enabled.
E-mail From	Type the sender's e-mail address. This address is used to reply e-mails.
E-mail To	Type the receiver's e-mail address.
E-mail Subject	Type the subject/title of the e-mail.

3.14 Event Detection Configuration

This device supports 3 types of event detection: Motion Detection, Camera Tampering, and Audio Detection.

3.14.1 Motion Detection

Use this menu to specify motion detection window 1 to window 10 and set the conditions for detection while observing a captured image.

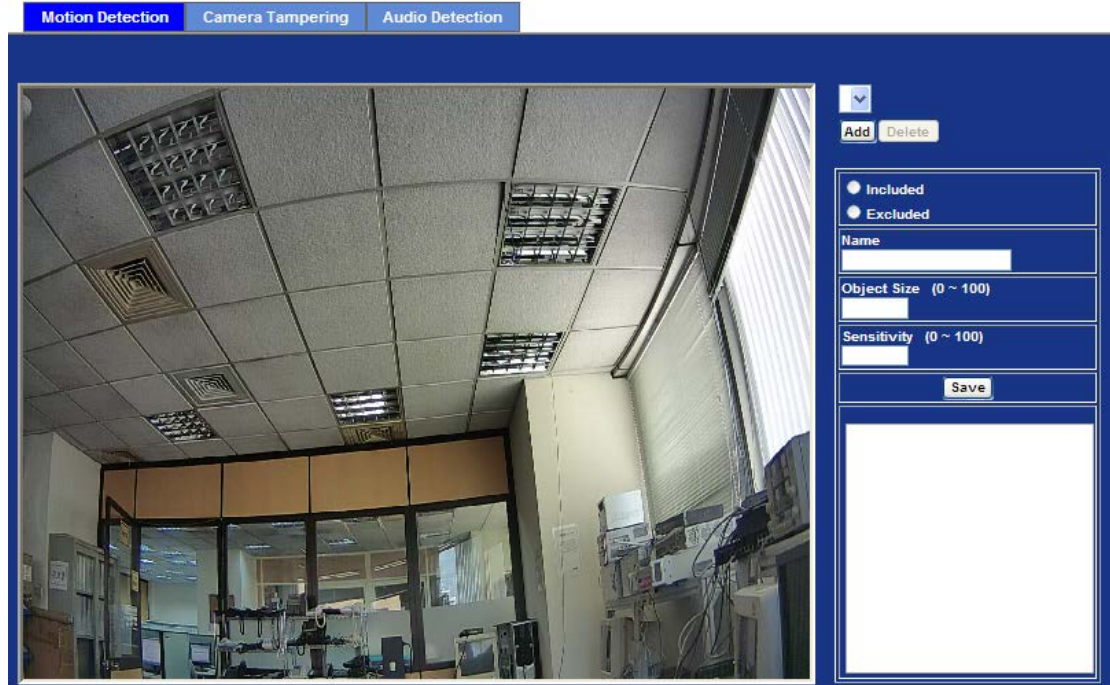

Add and Delete

To add or delete the motion windows. User can specify up to 4 included and/or excluded windows to monitor the video captured by this device. By dragging mouse on the image, you can change the position and size of the selected motion window accordingly.

Included or Excluded Window

These windows can be specified as Included or Excluded type.

Included windows target specific areas within the whole video image

Excluded windows define areas within an Include window that should be ignored (areas outside Include windows that are automatically ignored)

Name

Name of the specified motion window.

Object Size

Define the object size of motion detection. The higher object size will only trigger motion detection for larger objects. The lower object size will trigger motion detection for even small objects, too. Generally speaking, the smaller size will be easier to trigger event.

Sensitivity

Define the sensitivity value of motion detection. The higher value will be more sensitivity.

3.14.2 Camera Tampering

Camera tampering detection is a new intelligent functionality that further strengthens the benefit of Network Camera. When the camera is moved, partially obscured, severely defocused, covered or sprayed, an event can be triggered to send notifications, and upload images/files to remote server or email.

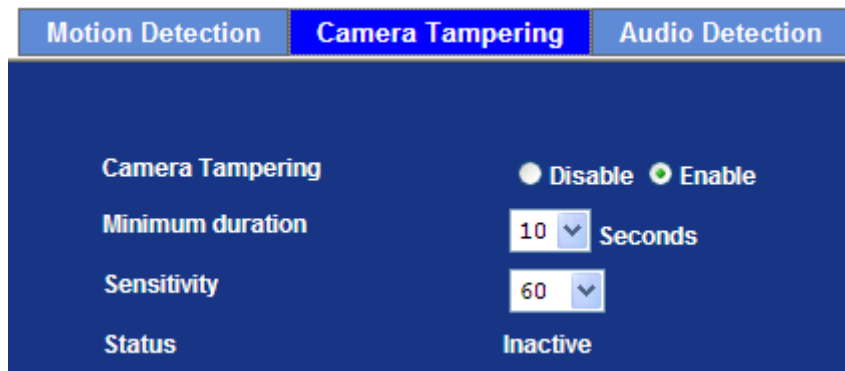

Minimum Duration

Define the minimum triggered duration by camera tampering detection. The triggered duration less than target value will be ignored to filter false alarms.

Sensitivity

The higher value will be more sensitivity.

3.14.3 Audio Detection

Audio detection alarm can be used as a complement to motion detection. Since audio detection can react to events in areas too dark for the video motion detection functionality to work properly. In addition, it can be used to detect activity in areas outside of the camera's view.

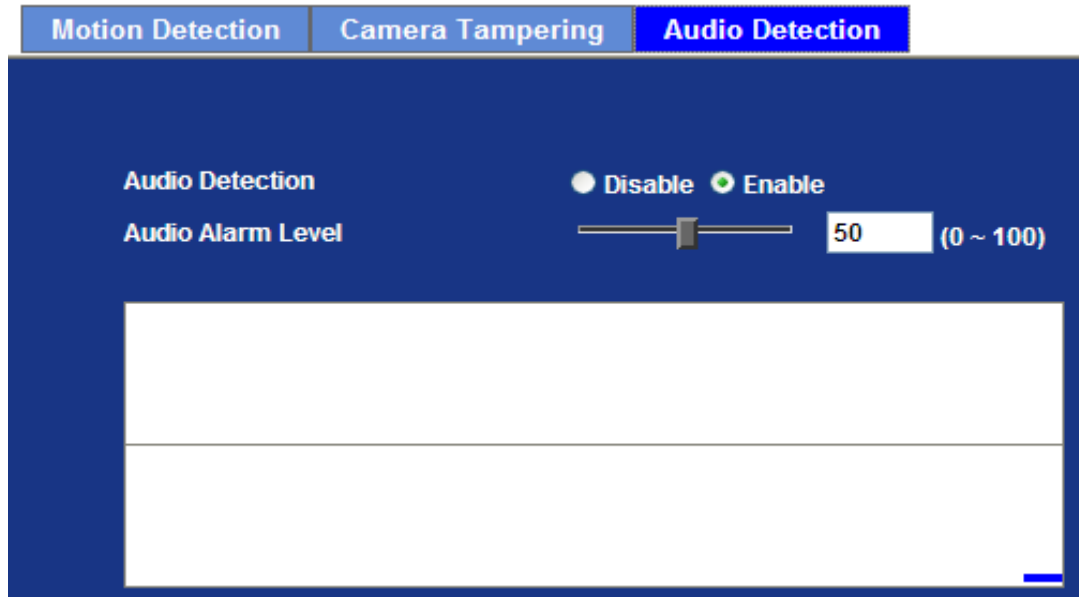

Audio Alarm Level

Define the threshold value of audio detection.

3.15 Storage Configuration

This page shows the status of the attached SD card, Samba server and iSCSI. You may also set up related parameters to manage the attached SD card, Samba server or iSCSI.

3.15.1 SD Card

SD Card
SAMB Server
iSCSI

Disk ID	<input style="width: 90%;" type="text" value="SD_DISK"/>	<input type="button" value="Mount"/>	<input type="button" value="Unmount"/>	
Status	Free space	<input style="width: 80%;" type="text" value="0% - 0 KB"/>	<input type="button" value="Reload"/>	<input type="button" value="Format"/>
	Total size	<input style="width: 80%;" type="text" value="0 MB"/>		
	Status	<input style="width: 90%;" type="text" value="No SD card inserted"/>		
	Full	<input style="width: 90%;" type="text" value="Yes"/>		
	Readonly	<input style="width: 90%;" type="text" value="No"/>		
<input checked="" type="checkbox"/> Enable automatic disk cleanup				
	Remove recordings older than:	<input style="width: 40%;" type="text" value="7"/>	day(s)	
	Remove oldest recordings when disk is:	<input style="width: 40%;" type="text" value="95"/>	% full	
<input type="checkbox"/> Lock disk				

Disk ID	This name of SD card.
----------------	-----------------------

Status	This information of SD card.
---------------	------------------------------

Enable automatic disk cleanup	Delete old recorded files while the conditions are reached as below.
--------------------------------------	--

Remove recordings order than	Delete old files by days.
-------------------------------------	---------------------------

Remove oldest recordings when disk is	Delete old files by left capacity.
--	------------------------------------

Lock disk	Avoid writing data and deleting at SD card
------------------	--

3.15.2 SAMBA Server

SD Card **SAMBA Server** iSCSI

Host (1 ~ 63 Digits)

Share (1 ~ 63 Digits)

User Name (< 64 Digits)

Password (< 64 Digits)

Status Not Connect

Total size 0 KB

Free space 0% - 0 KB

SAMBA Server

Host Type the server name or the IP address of the SAMBA server.

Share Set working directory path of SAMBA server.

User Name Type the user name for the SAMBA server

Password Type the password for the SAMBA server.

3.15.3 iSCSI

SD Card SAMBA Server **iSCSI**

IP Address

User Name

Password

Status Not Connect

Target

IP Address Type the IP address of the iSCSI.

User Name Type the user name for the SAMBA server

Password Type the password for the SAMBA server.

Status/Target iSCSI status and login/logout action.

3.16 Continuous Recording Configuration

You may enable or disable continuous recording function here. Select SD card, Samba server or iSCSI for storage destination.

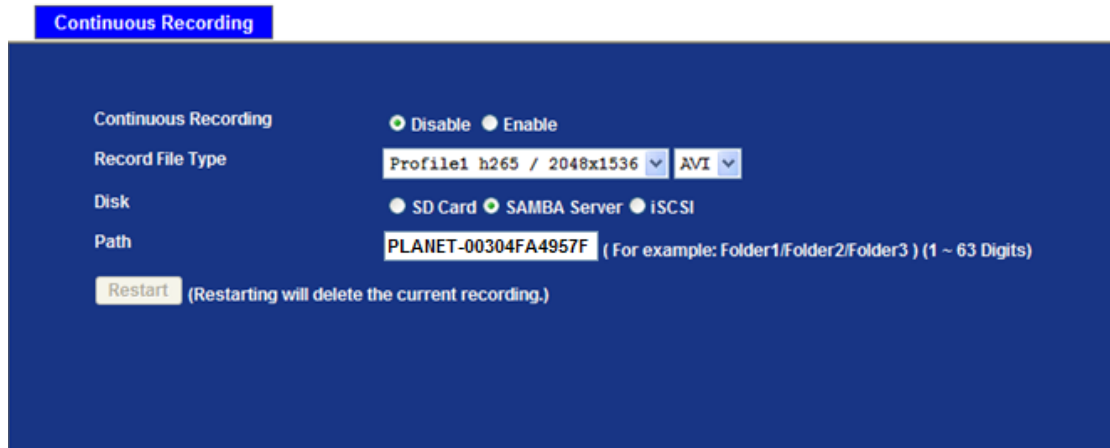

Continuous Recording	Enable or disable this function.
Record File Type	Choose a video profile to record.
Disk	Save recorded files to SD card, Samba server or iSCSI.
Path	Define the folder path for the recorded files.
Restart	Be careful not to click this button or all the files recorded on storage destination will be deleted.



Note There are various factors affecting the recording results, such as the camera's system loading, network condition, multiple clients accessing, and so on. No guarantee will be given to "seamless recording" in the recorded video files.

3.17 Recording List Configuration

3.17.1 Recording List

This page only shows the event recording files which are stored on SD card. User may play or delete the selected file.

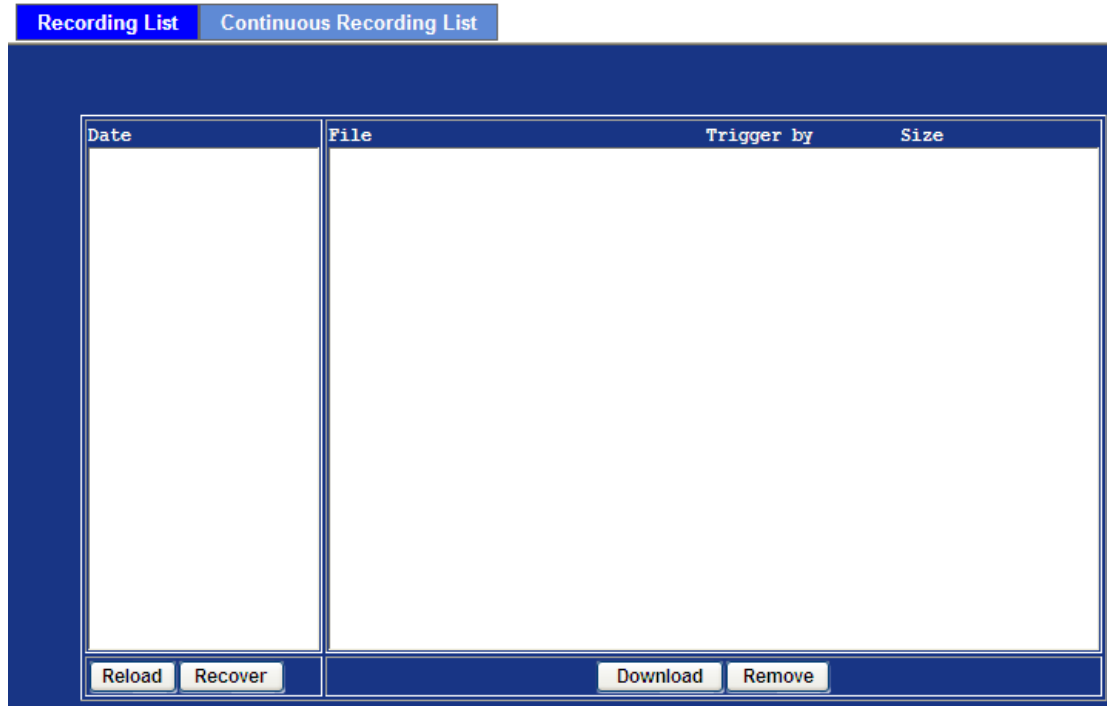

Recording List Continuous Recording List

Date	File	Trigger by	Size
------	------	------------	------

Reload Recover Download Remove

3.17.2 Continuous Recording List

This page shows the continuous recording files which are stored on SD card, Samba server or iSCSI. User may play or delete the selected file.

Recording List **Continuous Recording List**

Select Disk: SD Card SAMBA Server iSCSI
Disk: SD Card
Path: PLANET-00304FA28BD3

Date	File	Trigger by	Size
------	------	------------	------

3.18 Event Server Configuration

3.18.1 FTP Server

You may set up FTP parameters for further operation of Event Schedule. If users want to send an alarm message to an FTP server, it will need to configure parameters here and also add at least one event schedule to enable event triggering as SMTP.

FTP Server		TCP Server	HTTP Server	SAMBA Server
Name	FTP Server			FTP Port
Name	FTP Path			FTP Path
Name	FTP Server			
FTP Server	192.168.0.174	(< 64 Digits)	Test	
FTP Login Name	admin	(< 21 Digits)		
FTP Login Password	•••••	(< 21 Digits)		
FTP Port	21	(1 ~ 65535)		
FTP Path	admin/test	(< 64 Digits)		
FTP Passive Mode	<input checked="" type="radio"/> Disable <input type="radio"/> Enable			
Protocol	Normal			

Name

User can specify multiple FTP paths as he wishes. Therefore, user needs to specify a name for each FTP setting.

FTP Server

Type the server name or the IP address of the FTP server.

Test

Check the FTP server whether this account is available or not.

FTP Login Name

Type the user name for the FTP server.

FTP Login Password

Type the password for the FTP server.

FTP Port

Set port number of FTP service.

FTP Path

Set working directory path of FTP server.

FTP Passive Mode

Select passive or active mode connecting to FTP server.

Protocol	<p>Normal: Set it as normal if the FTP server is unencrypted FTP that defaults over port 21.</p> <p>FTPS: Set it as FTPS if the FTP server is over implicit SSL/TLS encrypted that defaults over port 990.</p> <p>FTPES: Set it as FTPES if the FTP server is over explicit SSL/TLS.</p>
-----------------	---

3.18.2 TCP Server

In addition to sending video file to FTP server, the device also can send event message to specified TCP server.

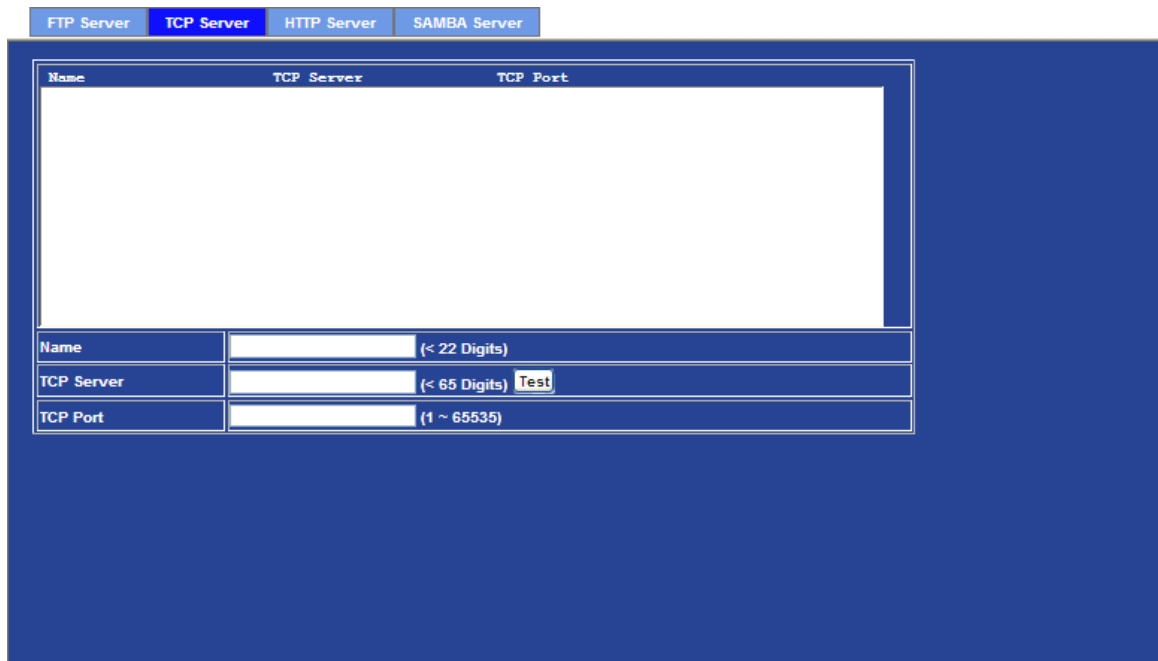

Name	User can specify multiple TCP servers as he wishes. Therefore, user needs to specify a name for each TCP server setting.
TCP Server	Type the server name or the IP address of the TCP server.
TCP Port	Set port number of TCP server.

3.18.3 HTTP Server

The device also can send event message to the specified HTTP server.

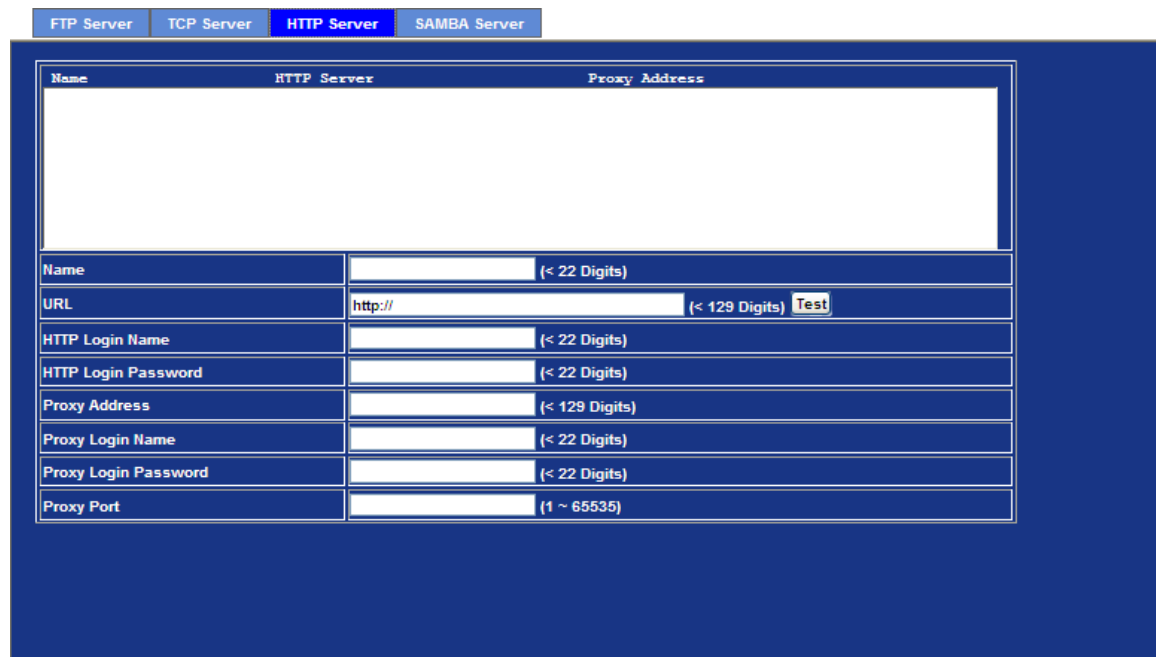

Name

User can specify multiple HTTP servers as he wishes. Therefore, user needs to specify a name for each HTTP server setting.

URL

Type the server name or the IP address of the HTTP server.

Test

Check the HTTP server whether it is available or not.

HTTP Login Name

Type the user name for the HTTP server.

HTTP Login Password

Type the password for the HTTP server.

Proxy Address

Type the server name or the IP address of the HTTP Proxy.

Proxy Login Name

Type the user name for the HTTP Proxy.

Proxy Login Password

Type the password for the HTTP Proxy.

Proxy Port

Set port number of Proxy.

3.18.4 SAMBA Server

The device also can send video stream to the specified SAMBA server. Most of the times, the SAMBA server will be another PC or NAS server.



Name	SAMBA Server	SAMBA Path
samba	192.168.0.201	share

Name	samba	(< 22 Digits)
SAMBA Server	192.168.0.201	(< 65 Digits) Test
SAMBA Login Name	test	(< 22 Digits)
SAMBA Login Password	*****	(< 22 Digits)
SAMBA Path	share	(< 65 Digits)

Name

User can specify multiple HTTP servers as he wishes. Therefore, user needs to specify a name for each HTTP server setting.

SAMBA Server

Type the server name or the IP address of the SAMBA server.

Test

Check the SAMBA server whether this account is available or not.

SAMBA Login name

Type the user name for the SAMBA server.

SAMBA Login Password

Type the password for the SAMBA server.

SAMBA Path

Set working directory path of SAMBA server.

3.19 Event Schedule Configuration

This menu is used to specify the schedule of Events and activate some actions provided by this device.

3.19.1 Setting

Setting		Record	Port Status																
<table border="1"> <thead> <tr> <th>Name</th> <th>Enable</th> <th>Type</th> <th>Weekday</th> <th>Start</th> <th>Duration</th> <th>Trigger by Prefix</th> <th>Action</th> </tr> </thead> <tbody> <tr> <td colspan="8" style="height: 100px;"></td> </tr> </tbody> </table>				Name	Enable	Type	Weekday	Start	Duration	Trigger by Prefix	Action								
Name	Enable	Type	Weekday	Start	Duration	Trigger by Prefix	Action												
Name	<input type="text"/>																		
Enable	<input checked="" type="radio"/> Yes <input type="radio"/> No																		
Type	<input checked="" type="radio"/> Event Trigger <input type="radio"/> Schedule Trigger, Interval <input type="text" value="60"/> (Seconds)																		
Enable Time	<input checked="" type="checkbox"/> Sun <input checked="" type="checkbox"/> Mon <input checked="" type="checkbox"/> Tue <input checked="" type="checkbox"/> Wed <input checked="" type="checkbox"/> Thu <input checked="" type="checkbox"/> Fri <input checked="" type="checkbox"/> Sat Start from <input type="text" value="0"/> : <input type="text" value="0"/> , Duration <input type="text" value="24"/> : <input type="text" value="0"/> ((max 168:00 hours)																		
Trigger by	<input type="checkbox"/> Sensor <input type="text" value="Change to active"/> <input type="checkbox"/> Motion Area <input type="text" value="DefaultWindow"/> <input type="checkbox"/> Camera Tampering <input type="checkbox"/> Audio Detection <input type="text" value="Over Alarm Level"/> <input type="checkbox"/> SD Card Read/Write Fail Detection <input type="text" value="10"/> Minute <input type="checkbox"/> Network Disconnect																		
Record File Prefix	<input type="text"/> (0 ~ 48 Digits)																		

Action	<input type="checkbox"/> Voice Alert, Duration <input type="text" value="5"/> (0~86400 Seconds)
	<input type="checkbox"/> Alarm Out, Duration <input type="text" value="5"/> (0~86400 Seconds)
	<input type="checkbox"/> Send FTP <input type="text" value=""/>
	<input type="checkbox"/> Send TCP <input type="text" value=""/>
	<input type="checkbox"/> Send HTTP <input type="text" value=""/>
	<input type="checkbox"/> Send E-Mail
	<input type="checkbox"/> Send SD (When event is triggered by "Network Disconnect", it will do continuous recording.)
	<input type="checkbox"/> Send Samba <input type="text" value="1"/>
	<input type="checkbox"/> ICR <input type="text" value="0"/> (0~86400 Seconds)
	<input type="checkbox"/> Mobile Phone Notification

Name Name of the Event or Schedule.

Enable Enable or disable this Event or Schedule.

Type Select Event trigger or Schedule trigger.

Enable Time Define the feasible time slot.

Trigger by	Select the triggered sources with event trigger.
Record File Prefix	Define the prefix of recorded filename
Action	Define the actions once event is triggered.

Example 1.

Name	FTP
Enable	<input checked="" type="radio"/> Yes <input type="radio"/> No
Type	<input checked="" type="radio"/> Event Trigger <input type="radio"/> Schedule Trigger, Interval <input type="text" value="60"/> (Seconds)
Enable Time	<input checked="" type="checkbox"/> Sun <input checked="" type="checkbox"/> Mon <input checked="" type="checkbox"/> Tue <input checked="" type="checkbox"/> Wed <input checked="" type="checkbox"/> Thu <input checked="" type="checkbox"/> Fri <input checked="" type="checkbox"/> Sat Start from <input type="text" value="0"/> : <input type="text" value="0"/> , Duration <input type="text" value="24"/> : <input type="text" value="0"/> ((max 168:00 hours)
Trigger by	<input type="checkbox"/> Sensor <input type="text" value="Change to active"/> <input checked="" type="checkbox"/> Motion Area <input type="text" value="DefaultWindow"/> <input type="checkbox"/> Camera Tampering <input type="checkbox"/> Audio Detection <input type="text" value="Over Alarm Level"/> <input type="checkbox"/> SD Card Read/Write Fail Detection <input type="text" value="10"/> Minute <input type="checkbox"/> Network Disconnect
Record File Prefix	<input type="text"/> (0 ~ 48 Digits)
Action	<input type="checkbox"/> Voice Alert, Duration <input type="text"/> (0~86400 Seconds) <input type="checkbox"/> Alarm Out, Duration <input type="text"/> (0~86400 Seconds) <input checked="" type="checkbox"/> Send FTP <input type="text" value="FTP"/> <input type="checkbox"/> Send TCP <input type="text"/> <input type="checkbox"/> Send HTTP <input type="text"/> <input type="checkbox"/> Send E-Mail <input type="checkbox"/> Send SD (When event is triggered by "Network Disconnect", it will do continuous recording.) <input type="checkbox"/> Send Samba <input type="text" value="SAMBAA"/> <input type="checkbox"/> ICR <input type="text"/> (0~86400 Seconds) <input type="checkbox"/> Mobile Phone Notification

Send file to FTP server triggered by motion:

1. Select event trigger
2. Enable time: Start from 00:00 to 24:00 every day
3. Triggered by: Motion Area (Added to the Object Detection page)
4. Action : Send FTP (Add in Event Server -> FTP Server page)

Example 2.

Name	E-mail
Enable	<input checked="" type="radio"/> Yes <input type="radio"/> No
Type	<input checked="" type="radio"/> Event Trigger <input type="radio"/> Schedule Trigger, Interval 60 (Seconds)
Enable Time	<input type="checkbox"/> Sun <input type="checkbox"/> Mon <input type="checkbox"/> Tue <input type="checkbox"/> Wed <input type="checkbox"/> Thu <input checked="" type="checkbox"/> Fri <input checked="" type="checkbox"/> Sat Start from 18 0 , Duration 12 0 ((max 168:00 hours)
Trigger by	<input type="checkbox"/> Sensor Change to active <input checked="" type="checkbox"/> Motion Area DefaultWindow <input type="checkbox"/> Camera Tampering <input type="checkbox"/> Audio Detection Over Alarm Level <input type="checkbox"/> SD Card Read/Write Fail Detection 10 Minute <input type="checkbox"/> Network Disconnect
Record File Prefix	(0 ~ 48 Digits)
Action	<input type="checkbox"/> Voice Alert, Duration (0~86400 Seconds) <input type="checkbox"/> Alarm Out, Duration (0~86400 Seconds) <input type="checkbox"/> Send FTP FTP <input type="checkbox"/> Send TCP <input type="checkbox"/> Send HTTP <input checked="" type="checkbox"/> Send E-Mail To email address test@planet.com.tw Subject Test Message Test <input checked="" type="checkbox"/> Attached file

Send file to e-mail server triggered by motion (from Friday 18:00 to Saturday 06:00):

1. Select event trigger.
2. Enable time: Start from Friday 18:00 and keep working for 12 hours, until it stops on Saturday 06:00.
3. Triggered by: Motion Area (Added to Object Detection page)
4. Action: Send e-mail (Add to E-mail page)
 - i. To email address: You need to input the receiver email address.
 - ii. Subject: You could specify the email subject.
 - iii. Message: You could specify the email content.

Example 3.

Name	Voice Alert
Enable	<input checked="" type="radio"/> Yes <input type="radio"/> No
Type	<input type="radio"/> Event Trigger <input checked="" type="radio"/> Schedule Trigger, Interval 600 (Seconds)
Enable Time	<input type="checkbox"/> Sun <input checked="" type="checkbox"/> Mon <input checked="" type="checkbox"/> Tue <input checked="" type="checkbox"/> Wed <input checked="" type="checkbox"/> Thu <input checked="" type="checkbox"/> Fri <input type="checkbox"/> Sat Start from 18 0 , Duration 6 0 ((max 168:00 hours)
Trigger by	<input type="checkbox"/> Sensor Change to active <input type="checkbox"/> Motion Area DefaultWindow <input type="checkbox"/> Camera Tampering <input type="checkbox"/> Audio Detection Over Alarm Level <input type="checkbox"/> SD Card Read/Write Fail Detection 10 Minute <input type="checkbox"/> Network Disconnect
Record File Prefix	(0 ~ 48 Digits)
Action	<input checked="" type="checkbox"/> Voice Alert, Duration 10 (0~86400 Seconds) <input type="checkbox"/> Alarm Out, Duration (0~86400 Seconds) <input type="checkbox"/> Send FTP FTP <input type="checkbox"/> Send TCP <input type="checkbox"/> Send HTTP <input type="checkbox"/> Send E-Mail <input type="checkbox"/> Send SD (When event is triggered by "Network Disconnect", it will do continuous recording.) <input type="checkbox"/> Send Samba SAMBA <input type="checkbox"/> ICR (0~86400 Seconds) <input type="checkbox"/> Mobile Phone Notification

Enable Voice Alert every 10 minutes during 18:00 to 24:00 from Monday to Friday.

1. Type: Select schedule trigger and interval is 10 minutes.
2. Enable Time: Select Monday to Friday, and set start time from 18:00 and keep working for 6 hours.
3. Triggered by: You do not need to choose it because this will be triggered every minute.
4. Action: Voice Alert.

3.19.2 Record

User can choose the type of record file for event or schedule application.

<div style="display: flex; justify-content: space-around;"> Setting Record Port Status </div>	
Record File Type	Profile1 h265 / 2048x1536 avi
Record File Prefix	(0 ~ 20 Digits)
Pre Trigger Duration	5 (0 ~ 20 Seconds)
Best Effort Duration	30 (1 ~ 60 Seconds)
Max File Size	3072 (256 ~ 3072 KB)

Record File Type	Choose one of the profiles for recording. If the profile is H.265/H.264, the format of recorded file is avi. If the profile is MJPEG, the format of recorded file is jpeg. User is able to select the profile type (H.265/H.264/MJPEG) in Video Profile page.
Record File Prefix	Define the prefix of recorded filename.
Pre-Trigger Duration	Define the maximum duration of pre-alarm.
Best Effort Duration	Define the best effort duration of post-alarm.
Max File Size	Define the maximum buffer size of record file.

3.19.3 Port Status

User can check the status of digital input and output (DIDO).

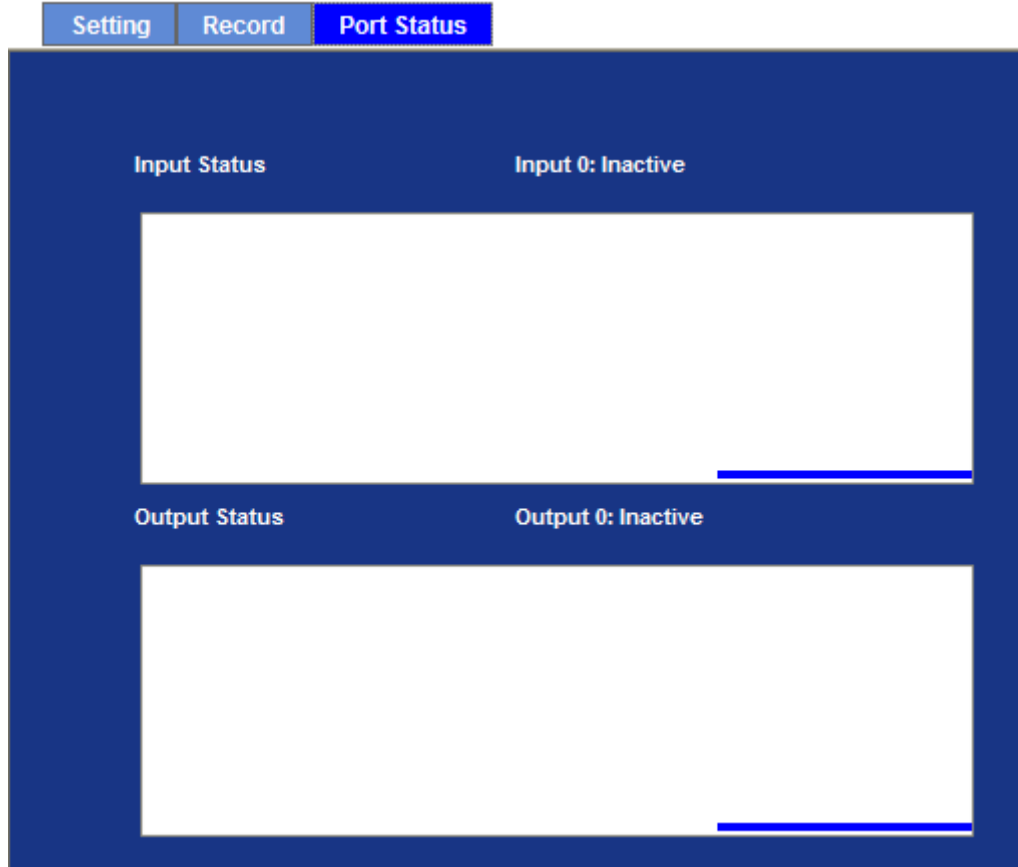

Input Status Show either inactive or active.

Output Status Show either inactive or active.

Appendix A: Ping IP Address

The ping (or Packet Internet Groper) command is used to detect whether a specific IP address is accessible by sending a packet to the specific address and waiting for a reply. It's also a very useful tool to confirm whether Internet camera is installed or not, or if the IP address conflicts with any other device over the network.

If you want to make sure the IP address of the camera, utilize the ping command as follows:

- Start a DOS window.
- Type ping x.x.x.x, where x.x.x.x is the IP address of the camera.

The replies, as illustrated below, will provide an explanation to the problem.



```
Command Prompt
Microsoft Windows XP [Version 5.1.2600]
(C) Copyright 1985-2001 Microsoft Corp.

D:\Documents and Settings\Administrator>PING 192.168.0.20

Pinging 192.168.0.20 with 32 bytes of data:

Reply from 192.168.0.20: bytes=32 time<1ms TTL=64
Reply from 192.168.0.20: bytes=32 time<1ms TTL=64
Reply from 192.168.0.20: bytes=32 time<1ms TTL=64
Reply from 192.168.0.20: bytes=32 time<1ms TTL=64

Ping statistics for 192.168.0.20:
    Packets: Sent = 4, Received = 4, Lost = 0 (0% loss),
    Approximate round trip times in milli-seconds:
        Minimum = 0ms, Maximum = 1ms, Average = 0ms

D:\Documents and Settings\Administrator>_
```

If you want to detect any other device conflicting with the IP address of Internet camera, you also can utilize the ping command but you must disconnect the Internet camera from the network first.

Appendix B: Bandwidth and Video Size Estimation

The frame rate of video transmitted from the device depends on connection bandwidth between client and server, video resolution, codec type, and quality setting of server. Here is a guideline to help you roughly estimate the bandwidth requirements from your device.

The required bandwidth depends on content of video source. The slow motion video will produce smaller bit rate generally and fast motion will produce higher bit rate. Actual results generated by the device may vary.

Image Resolution	Average range of data sizes for JPEG mode	Average bit rate for MPEG4 mode	Average bit rate for H.264 mode
320 x 240	8 ~ 20k byte per frame	256kbps~768kbps @ 30fps	192kbps~512kbps @ 30fps
640 x 480	20 ~ 50K byte per frame	512kbps~3072kbps @ 30fps	384kbps~1536kbps @ 30fps
1920 x 1080	200 ~ 500k byte per frame	-	1536kbps~10000kbps @ 30fps
2048 x 1536	300 ~ 750k byte per frame	-	2048kbps~12000kbps @ 30fps



Audio streaming also takes bandwidth around 32kbps. Some xDSL/Cable modem upload speeds could not even reach up to 128 kbps. Thus, you may not be able to receive good quality video while also streaming audio on a 128 kbps or lower connection. Even though the upload speed is more than 128kbps for optimal video performance, disabling audio streaming will get better video performance.

Appendix C: DDNS Application

Configuring PLANET DDNS:

Step 1: Visit DDNS provider's web site and register an account if you do not have one yet. For example, register an account at <http://planetddns.com>

Step 2: Enable DDNS option through accessing web page of the camera.

Step 3: Input all DDNS settings.

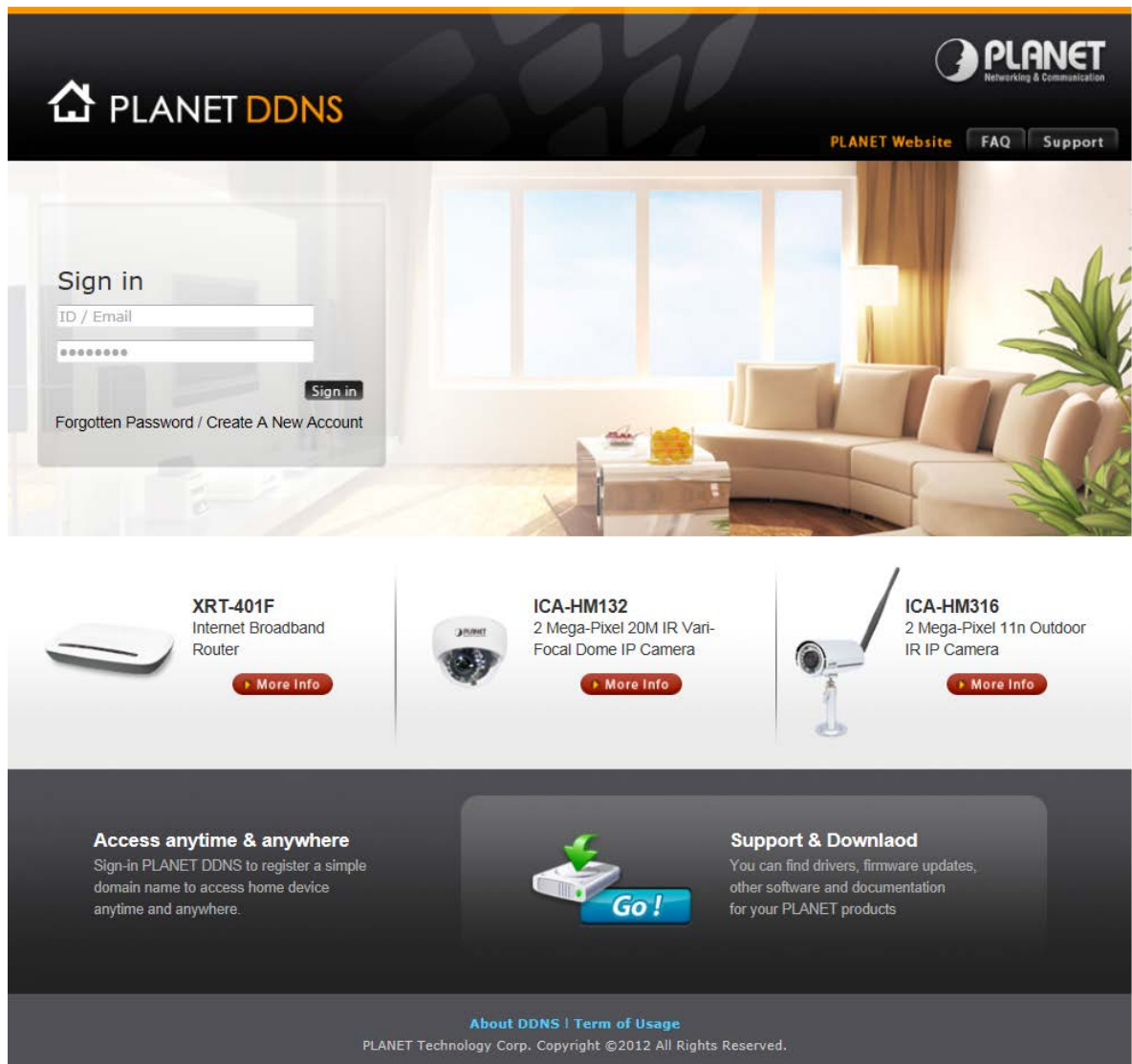

The screenshot shows the PLANET DDNS website. At the top, there is a navigation bar with the PLANET logo, a home icon, and the text 'PLANET DDNS'. On the right side of the navigation bar, there are links for 'PLANET Website', 'FAQ', and 'Support'. Below the navigation bar, there is a large image of a modern living room with a sofa and a coffee table. Overlaid on this image is a 'Sign in' form with fields for 'ID / Email' and a password field, a 'Sign in' button, and links for 'Forgotten Password / Create A New Account'. Below the sign-in form, there are three product cards: 1. 'XRT-401F Internet Broadband Router' with a 'More Info' button. 2. 'ICA-HM132 2 Mega-Pixel 20M IR Vari-Focal Dome IP Camera' with a 'More Info' button. 3. 'ICA-HM316 2 Mega-Pixel 11n Outdoor IR IP Camera' with a 'More Info' button. At the bottom of the page, there is a dark grey footer area. On the left, it says 'Access anytime & anywhere' and 'Sign-in PLANET DDNS to register a simple domain name to access home device anytime and anywhere.' In the center, there is a 'Go!' button with a green arrow icon. On the right, it says 'Support & Download' and 'You can find drivers, firmware updates, other software and documentation for your PLANET products'. At the very bottom, there are links for 'About DDNS | Term of Usage' and the copyright notice 'PLANET Technology Corp. Copyright ©2012 All Rights Reserved.'

Appendix D: Configuring Port Forwarding Manually

The device can be used with a router. If the device wants to be accessed from the WAN, its IP address needs to be set up as fixed IP address. Port forwarding or Virtual Server function of router also needs to be set up. This device supports UPnP traversal function. Therefore, user could use this feature to configure port forwarding of NAT router first. However, if user needs to configure port forwarding manually, please follow the steps below:

Manually installing the device with a router on your network is an easy 3-step procedure shown below:

1. Assign a local/fixed IP address to your device
2. Access the Router with Your Web browser
3. Open/Configure Virtual Server Ports of Your Router

1. Assign a local/fixed IP address to your device

The device must be assigned a local and fixed IP address that allows it to be recognized by the router. Manually set up the device with a fixed IP address, for example, *192.168.0.100*.

2. Access the Router with Your Web browser

The following steps generally apply to any router that you have on your network. PLANET WNRT-620 is used as an example to clarify the configuration process. Configure the initial settings of the router by following the steps outlined in the router's **Quick Installation Guide**.

If you have cable or DSL service, you will most likely have a dynamically assigned WAN IP address. 'Dynamic' means that your router's WAN IP address can change from time to time depending on your ISP. A dynamic WAN IP Address identifies your router on the public network and allows it to access the Internet. To find out what your router's WAN IP address is, go to the **Status** screen on your router and locate the WAN information for your router. As shown on the following page the WAN IP Address will be listed. This will be the address that you will need to type in your web browser to view your camera over the Internet. Be sure to uncheck the **Reset IP address at next boot** button at the top of the screen after modifying the IP address. Failure to do so will reset the IP address when you restart your computer.

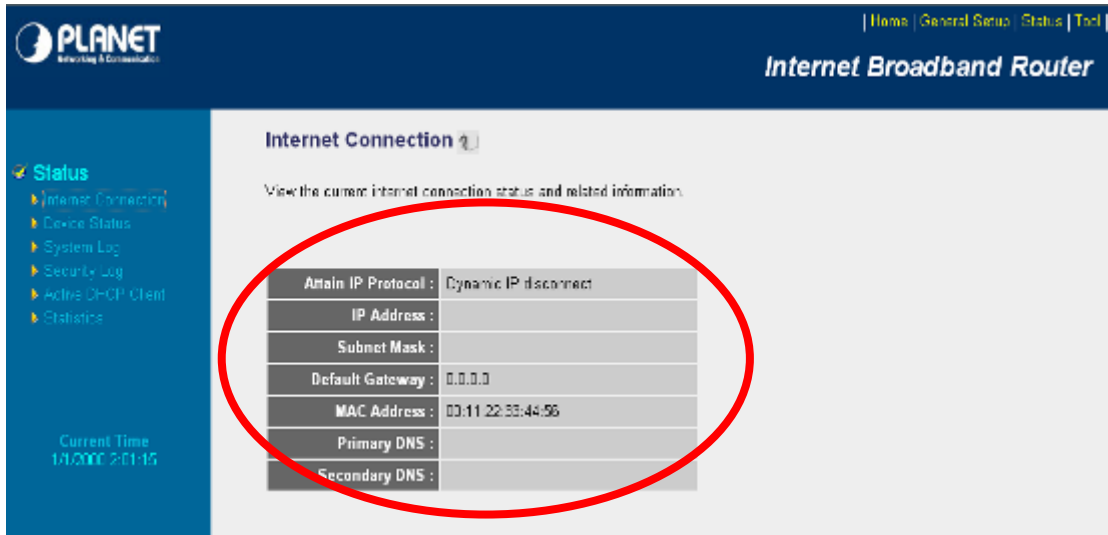

Your WAN IP address will be listed here.

3. Open/set Virtual Server Ports to enable remote image viewing

The firewall security features built into the router and most routers prevent users from accessing the video from the device over the Internet. The router connects to the Internet over a series of numbered ports. The ports normally used by the device are blocked from access over the Internet. Therefore, these ports need to be made accessible over the Internet. This is accomplished using the **Virtual Server** function on the router. The Virtual Server ports used by the camera must be opened through the router for remote access to your camera.

Follow these steps to configure your router's Virtual Server settings:

- Click **Enabled**.
- Enter a unique name for each entry.
- Select **Both** under **Protocol Type (TCP and UDP)**
- Enter your camera's local IP address (e.g., **192.168.0.100**) in the **Private IP** field.
- If you are using the default camera port settings, enter **80** into the **Public** and **Private Port** section, click **Add**.

A check mark appearing before the entry name will indicate that the ports are enabled.



Note

Some ISPs block access to port 80. Be sure to check with your ISP so that you can open the appropriate ports accordingly. If your ISP does not pass traffic on port 80, you will need to change the port the camera uses from 80 to something else, such as 8080. Not all routers are the same, so refer to your user manual for specific instructions on how to open ports.

| Home | General Setup | Status | Tool |

Internet Broadband Router

- System
- WAN
- LAN
- Wireless
- QoS
- NAT
 - ▶ Port Forwarding
 - ▶ **Virtual Server**
 - ▶ Special applications
 - ▶ UPnP Setting
 - ▶ ALG Settings
- Firewall

Virtual Server ?

You can configure the Broadband router as a Virtual Server so that remote users accessing services such as the Web or FTP at your local site via Public IP Addresses can be automatically redirected to local servers configured with Private IP Addresses. In other words, depending on the requested service (TCP/UDP) port number, the Broadband router redirects the external service request to the appropriate internal server (located at one of your LAN's Private IP Address).

Enable Virtual Server

Private IP	Private Port	Type	Public Port	WAN Port	Comment
<input type="text"/>	<input type="text"/>	Both	<input type="text"/>	WAN1	<input type="text"/>

Current Virtual Server Tables

Private IP	Private Port	Type	Public Port	WAN Port	Comment	Select
192.168.0.100	80	TCP+UDP	80	WAN1	ICA-HM230	<input type="checkbox"/>

Enter valid ports in the **Virtual Server** section of your router. Please make sure to check the box on this line to enable settings. Then the device can be accessed from WAN by the router's WAN IP address.

By now, you have finished your entire PC configuration for this device.

Appendix E: Power Line Frequency

COUNTRY	VOLTAGE	FREQUENCY	COMMENTS
Argentina	220V	50 Hz	*Neutral and line wires are reversed from that used in Australia and elsewhere.
Australia	230V*	50 Hz	*Outlets typically controlled by adjacent switch. Though <i>nominal</i> voltage has been officially changed to 230V, 240V is within tolerances and commonly found.
Austria	230V	50 Hz	
Brazil	110/220V*	60 Hz	*127V found in states of Bahia, Paraná (including Curitiba), Rio de Janeiro, Paulo and Minas Gerais (though 220V may be found in some hotels). Other areas are 220V only, with the exception of Fortaleza (240V).
Canada	120V	60 Hz	
China	220V	50 Hz	
Finland	230V	50 Hz	
France	230V	50 Hz	
Germany	230V	50 Hz	
Hong Kong	220V*	50 Hz	
India	230V	50 Hz	
Italy	230V	50 Hz	
Japan	100V	50/60 Hz*	*Eastern Japan 50 Hz (Tokyo, Kawasaki, Sapporo, Yokohoma, and Sendai); Western Japan 60 Hz (Osaka, Kyoto, Nagoya, Hiroshima)
Malaysia	240V	50 Hz	
Netherlands	230V	50 Hz	
Portugal	230V	50 Hz	
Spain	230V	50 Hz	
Sweden	230V	50 Hz	
Switzerland	230V	50 Hz	

Taiwan	110V	60 Hz	
Thailand	220V	50 Hz	
United Kingdom	230V*	50 Hz	*Outlets typically controlled by adjacent switch. Though nominal voltage has been officially changed to 230V, 240V is within tolerances and commonly found.
United States of America	120V	60 Hz	

Appendix F: Troubleshooting & Frequently Asked Questions

Features	
The video and audio codec is adopted in the device.	<p>The device utilizes H.265, H.264 and M-JPEG compressions to provide high quality images. Where H.265 and H.264 is standard for video compression, M-JPEG is a standard for image compression.</p> <p>The audio codec is defined as AMR for 3GPP and G.711/G.726 for RTSP streaming.</p>
The maximum number of users that accesses the device simultaneously.	<p>The maximum number of users is limited to 20. However, it also depends on the total bandwidth accessed to this device from clients. The maximum data throughput of the device is around 20~25Mbps for UDP mode and 10Mbps for HTTP mode. Therefore, the actual number of connected clients is varying by streaming mode, settings of resolution, codec type, frame rate and bandwidth. Obviously, the performance of the each connected client will slow down when many users are logged on.</p>
The device can be used outdoors or not.	<p>The device is weatherproof and could be installed outdoors.</p>
Installing this device	
Status LED does not light up.	<p>Check and confirm whether the RJ45 cable is connecting to PoE switch. Try to re-plug the cable again.</p>
The network cabling is required for the device.	<p>The device uses Category 5 UTP cable allowing 10/100BASE-TX networking.</p>
The device will be installed and work if a firewall exists on the network.	<p>If a firewall exists on the network, port 80 is open for ordinary data communication. The HTTP port and RTSP port need to be opened on the firewall or NAT router.</p>
The username and password used	<p>Username = admin and password = admin.</p>

for the first time or after factory default reset	Note that it's all case sensitive.
Forgot the username and password	<p>Follow the steps below.</p> <p>(1)Remove power, and press and hold the button on the back of IP camera.</p> <p>(2)Power on the camera. Don't release the button during the system booting.</p> <p>(3)It will take around 30 seconds to boot the camera.</p> <p>(4)Release the button when camera finishes process.</p> <p>(5)Re-login the camera using the default IP (http://192.168.0.20), and username (admin), password (admin).</p>
Forgot the IP address of the device	Check IP address of device by using PLANET IPWizard program or by UPnP discovery or set the device to default by reset button.
PLANET IP Wizard II program cannot find the device.	<ul style="list-style-type: none"> ● Re-power the device if you cannot find the unit within 1 minute. ● Do not connect device over a router. PLANET IP Wizard II program cannot detect device over a router. ● If IP address is not assigned to the PC running PLANET IP Wizard II program, then PLANET IP Wizard II program cannot find device. Make sure that IP address is assigned to the PC properly. ● Antivirus software on the PC might interfere with the setup program. Disable the firewall of the antivirus software during setting up this device. ● Check the firewall setting of your PC or Notebook.
Internet Explorer does not seem to work well with the device	Make sure that your Internet Explorer is version 11. If you are experiencing problems, try adding the camera's IP address to the IE11's compatible list.
PLANET IP Wizard II program fails to save the network parameters.	Network may have trouble. Confirm the parameters and connections of the device.

UPnP NAT Traversal	
Cannot work with NAT router	Maybe NAT router does not support UPnP function. Please check user's manual of router and turn on UPnP function.
Some IP cameras are working while others failed	Maybe too many IP cameras have been installed on the LAN, and then NAT router is out of resource to support more cameras. You could turn off and on NAT router to clear out of date information inside router.
Accessing this device	
Cannot access the login page and other web pages of the Internet Camera from Internet Explorer	<ul style="list-style-type: none"> ● Maybe the IP address of the Internet camera is already being used by another device or computer. To confirm this possible problem, disconnect the Internet camera from the network first, and then run the ping utility to check it out. ● Maybe due to the network cable. Try correcting your network cable and configuration. Test the network interface by connecting a local computer to the Internet camera via a crossover cable. ● Make sure the Internet connection and setting are ok. <p>Make sure to enter the IP address of Internet Explorer correctly. If the Internet camera has a dynamic address, it may have changed since you last checked it.</p> <ul style="list-style-type: none"> ● Network congestion may prevent the web page from appearing quickly. Wait for a while. <p>The IP address and subnet mask of the PC and Internet camera must be in the same class of the private IP address on the LAN.</p> <ul style="list-style-type: none"> ● Make sure the http port used by the Internet camera, default=80, is forwarded to the Internet camera's private IP address. ● The port number assigned in your Internet camera might not be available via Internet. Check your ISP for available port. ● The proxy server may prevent you from connecting directly to the Internet camera. Do not use the proxy server for the setup.

	<ul style="list-style-type: none"> ● Confirm whether Default Gateway address is correct. ● The router needs Port Forwarding feature. Refer to your router's manual for details. ● Packet filtering of the router may prohibit access from an external network. Refer to your router's manual for details. ● Access the Internet camera from the Internet with the global IP address of the router and port number of Internet camera. ● Some routers reject the global IP address to access the Internet camera on the same LAN. Access with the private IP address and correct port number of Internet camera. ● When you use DDNS, you need to set Default Gateway and DNS server address. ● If it's not working after the above procedure, reset Internet camera to default setting and install it again.
<p>Image or video does not appear on the main page.</p>	<ul style="list-style-type: none"> ● When the PC connects to Internet camera for the first time, a pop-up Security Warning window will appear to download ActiveX Controls. When using Windows XP, or Vista, log on with an appropriate account that is authorized to install applications. ● Network congestion may prevent the Image screen from appearing quickly. You may choose lower resolution to reduce the required bandwidth.
<p>How to check whether the device's ActiveX is installed on your computer</p>	<p>Go to C:\Windows\Downloaded Program Files and check to see if there is an entry for the file "I Camera Control". The status column should show "Installed". If the file is not listed, make sure your Security Settings in Internet Explorer are configured properly and then try reloading the device's home page. Most likely, the ActiveX control did not download and install correctly. Check your Internet Explorer security settings and then close and restart Internet Explorer. Try to browse and log in again.</p>
<p>Internet Explorer displays the following message: "Your current security settings prohibit</p>	<p>Set up the IE security settings or configure the individual settings to allow downloading and scripting of ActiveX controls.</p>

<p>downloading ActiveX controls”.</p>	
<p>The device works locally but not externally.</p>	<ul style="list-style-type: none"> ● Might be caused from the firewall protection. Check the Internet firewall with your system or network administrator. The firewall may need to have some settings changed in order for the device to be accessible outside your LAN. ● Make sure that the device isn't conflicting with any other web server running on your LAN. ● Check the configuration of the router settings allow the device to be accessed outside your local LAN. ● Check the bandwidth of Internet connection. If the Internet bandwidth is lower than target bit rate, the video streaming will not work correctly.
<p>The unreadable characters are displayed.</p>	<p>Use the operating system of the selected language. Set the Encoding or the Character Set of the selected language on the Internet Explorer.</p>
<p>Frame rate is slower than the setting.</p>	<ul style="list-style-type: none"> ● The traffic of the network and the object of the image affect the frame rate. The network congestion causes frame rate to slow down than the setting. ● Check the bandwidth of Internet connection. If the Internet bandwidth is lower than target bit rate, the video streaming will not work correctly. ● Ethernet switching hub can smooth the frame rate.
<p>Blank screen or very slow video when audio is enabled.</p>	<ul style="list-style-type: none"> ● Your connection to the device does not have enough bandwidth to support a higher frame rate for the streamed image size. Try reducing the video streaming size to 160x120 or 320x240 and/or disabling audio. ● Audio will consume 32 kbps. Disable audio to improve video. Your Internet connection may not have enough bandwidth to support streaming audio from the device.
<p>Image Transfer on e-mail or FTP</p>	<ul style="list-style-type: none"> ● Default Gateway and DNS server address should be set up

does not work.	<p>correctly.</p> <ul style="list-style-type: none"> ● If FTP does not work properly, ask your ISP or network administrator about the transferring mode of FTP server.
What is the app for smart phone/?	<ul style="list-style-type: none"> ● aCV5 for Android: https://play.google.com/store/apps/details?id=com.planet.acv5 ● iCV5 for iOS: https://itunes.apple.com/us/app/icv5/id1022207789?mt=8
What is the RTSP command?	<ul style="list-style-type: none"> ● The RTSP command: rtsp://IP/media/media.amp?streamprofile=Profile1 <p>If user wants to play profile 2, please input "Profile2".</p>
Video quality of the device	
The focus on the Camera is bad.	<p>The lens is dirty or dust is attached. Fingerprints, dust, stain, etc. on the lens can degrade the image quality.</p>
The color of the image is poor or strange.	<ul style="list-style-type: none"> ● Adjust White Balance. ● To ensure the images you are viewing are the best they can be, set the Display property setting (color quality) to 16 bit at least and 24 bit or higher if possible within your computer. ● The configuration on the device image display is incorrect. You need to adjust the image related parameters such as brightness, contrast, hue and sharpness properly.
Image flickers.	<ul style="list-style-type: none"> ● Wrong power line frequency makes images flicker. Make sure it is the 50 or 60Hz format of your device. ● If the object is dark, the image will flicker. Make the condition around the camera brighter.
Noisy images occur.	<p>The video images might be noisy if the device is located in a very low light environment. Make the condition around the camera brighter or turn the White-light LED on.</p>

Miscellaneous

Cannot play the recorded ASF file

Please install Microsoft®'s DirectX 9.0 or later and use the Windows Media Player 11.0 or later to play the AVI file recorded by the device.