

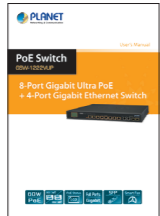

1. Package Contents

Thank you for purchasing PLANET 8-Port 10/100/1000T Ultra PoE + 2-Port 10/100/1000T + 2-Port 1000X SFP Gigabit Ethernet Switch, GSW-1222VUP. "Ultra PoE Gigabit Switch" mentioned in this manual refers to the GSW-1222VUP.

Open the box of the Ultra PoE Gigabit Switch and carefully unpack it. The box should contain the following items:

Ultra PoE Gigabit Switch x 1	User's Manual x 1
	
Power Cord x 1	Accessories x 1
	

If any of these pieces are missing or damaged, please contact your dealer immediately; if possible, retain the carton including the original packing material, and use them again to repack the product in case there is a need to return it to us for repair.

- 1 -

3. Product Specifications

Model	GSW-1222VUP
Hardware Specifications	
PoE Copper Ports	10 x 10/100/1000BASE-T RJ45 auto-MDI/MDI-X port
SFP/mini-GBIC Slots	2 x 1000BASE-X SFP interface
PoE Injector Ports	8 ports with Ultra PoE/802.3at/af PoE injector function with Port-1 to Port-8
Switch Architecture	Store-and-Forward
Switch Fabric	24Gbps/non-blocking
Switch Throughput@64 bytes	17.8Mpps@64Bytes
MAC Address Table	8K entries
Jumbo Packet Size	10K bytes
Flow Control	IEEE 802.3x pause frame for full-duplex Back pressure for half-duplex
LED	System: - Power (Green) Ultra PoE 10/100/1000BASE-T RJ45 Interfaces (port 1 to port 8): - 1000Mbps LNK/ACT (Green) - 10/100Mbps LNK/ACT (Orange) - PoE-in-Use (Orange)

- 3 -

PoE Power Output	Per port 54VDC, 600mA. max. 60 watts (Ultra PoE) Per port 54V DC, 600mA. max. 30 watts (IEEE 802.3at) Per port 54V DC, 300mA. max. 15.4 watts (IEEE 802.3af)
Power Pin Assignment	Ultra PoE: 1/2 (+), 3/6 (-), 4/5 (+), 7/8 (-) End-span: 1/2 (+), 3/6 (-) Mid-span: 4/5 (+), 7/8 (-)
PoE Power Budget	380 watts (max.)
PoE Ability PD @ 15 watts	8 units
PoE Ability PD @ 30 watts	8 units
PoE Ability PD @ 60 watts	6 units
Standards Conformance	
Regulatory Compliance	FCC Part 15 Class A, CE
Standards Compliance	IEEE 802.3 10BASE-T IEEE 802.3u 100BASE-TX IEEE 802.3ab Gigabit 1000BASE-T IEEE 802.3z Gigabit SX/LX IEEE 802.3x Flow control and back pressure IEEE 802.3af Power over Ethernet IEEE 802.3at Power over Ethernet Plus

- 5 -

4.2 LCD Monitor Indicators

The Ultra PoE Gigabit Switch has a brand-new LCD monitor designed for network administrator who can easily obtain real-time per PoE port output watts information and system status display, such as over voltage, low voltage, and PoE chipset over temperature function. The details of each message LCD monitor are shown below:

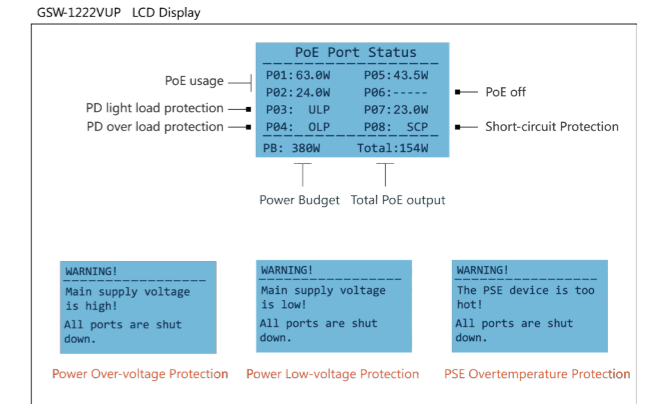

The detailed description of each item is shown below:

- OLP:** It means Over Load Protect.
- ULP:** It means Under Load Protect.
- SCP:** It means Short Circuit Protect.
- C-E:** It means PD device classification error.
- PB:** It means Power Budget.
- Total:** It means total PoE power output information.

- 7 -

2. Product Features

Physical Port

- 8-port 10/100/1000BASE-T Gigabit Ethernet RJ45 copper
- 2 10/100/1000BASE-T TP
- 2 1000BASE-X mini-GBIC SFP interfaces

Power over Ethernet

- Ultra Power over Ethernet end-span/mid-span PSE
- Up to 60 watts of power on 4-pair UTP
- Backward compatible with IEEE 802.3at/af PD device
- Up to 8 ports of IEEE 802.3af/IEEE 802.3at/Ultra PoE devices powered
- 54V DC, 60-watt PoE power output at maximum on each port
- 380-watt PoE budget
- Auto-detection of IEEE 802.3at/af PoE equipment and device to avoid possible damage by incorrect installation
- Circuit protection prevents power interference between ports
- Remote power feeding up to 100m

Hardware

- 19-inch size, 1U height, rack mountable
- LED indicators for system power, per port PoE ready and PoE activity, speed Link/Act
- LCD Monitor for system status and PoE usage status display
- 3 silent smart fans designed to provide stable and efficient power performance

- 2 -

LED	10/100/1000BASE-T RJ45 Interfaces (port 9 to port 10): - 1000Mbps LNK/ACT (Green) - 10/100Mbps LNK/ACT (Orange) 1000BASE-X SFP Interfaces (port 11 to port 12): - 1000Mbps LNK/ACT (Green)
LCD Monitor (W x D)	39.5mm x 24.8mm System Status/PoE Usage Port Status
Dimensions (W x D x H)	440 x 233 x 44 mm, 1U height
Enclosure	Metal
Weight	3.3kg
Power Requirements	100~240V AC, 50/60Hz, 6A max.
Power Consumption/Dissipation	Max. 420 watts/1433 BTU
Ventilation	Smart fan x 3 (Fans will be active once the PoE budget reaches 126 watts)
ESD Protection	Contact Discharge of ±4KV DC Air Discharge of ±6KV DC
Surge Immunity	±4KV
Power over Ethernet	
PoE Standard	IEEE 802.3af/802.3at/Ultra PoE PSE
PoE Power Supply Type	End-span + Mid-span

- 4 -

Environment	
Operating	Temperature: 0 ~ 50 degrees C Relative Humidity: 5 ~ 95% (non-condensing)
Storage	Temperature: -10 ~ 70 degrees C Relative Humidity: 5 ~ 95% (non-condensing)

- 5 -

4. Hardware Introduction

4.1 Front Panel

The Front Panel of the Ultra PoE Gigabit Switch consists of 8 auto-sensing 10/100/1000BASE-T 802.3af/802.3at/Ultra PoE Injector ports, 2 auto-sensing 10/100/1000BASE-T ports and 2 1000BASE-X SFP slots. The LED Indicators are also located on the front panel of the Ultra PoE Gigabit Switch.



Figure 1: GSW-1222VUP Switch Front Panel

- 6 -

4.3 LED Indicators

System

LED	Color	Function
PWR	Green	Lights to indicate the Switch has power.

Per 10/100/1000BASE-T Port (Port 1 to port 10)

LED	Color	Function
1000 LNK/ACT	Green	Lights to indicate the link through that port is successfully established at 1000Mbps. Blinks to indicate that the port is actively sending or receiving data.
10/100 LNK/ACT	Orange	Lights to indicate the link through that port is successfully established at 10/100Mbps. Blinks to indicate that the port is actively sending or receiving data.

Per Ultra POE 10/100/1000BASE-T Port (Port 1 to port 8)

LED	Color	Function
PoE-in-Use	Orange	Lights to indicate the port is providing 54V DC in-line power.

Per 1000BASE-X SFP Interface (Port 11 to port 12)

LED	Color	Function
1000 LNK/ACT	Green	Lights to indicate the link through that port is successfully established at 1000Mbps. Blinks to indicate that the port is actively sending or receiving data.

- 8 -

4.4 Rear Panel

The rear panel of the Ultra PoE Gigabit Switch indicates an AC power socket, which accepts input power from 100 to 240V AC, 50-60Hz, 6A.



Figure 2: GSW-1222VUP Switch Rear Panel

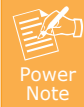

The device is a power-required device, which means it will not work till it is powered. If your networks should be active all the time, please consider using UPS (Uninterrupted Power Supply) for your device. It will prevent you from network data loss or network downtime.



In some areas, installing a surge suppression device may also help to protect your Ultra PoE Gigabit Switch from being damaged by unregulated surge or current to the Ultra PoE Gigabit Switch or the power adapter.

5. Installation

This part describes how to install your Ultra PoE Gigabit Switch and make connections to it. Please follow the procedures below:

- 9 -

Rack Mounting

To install the Ultra PoE Gigabit Switch in a 19-inch standard rack, follow the instructions described below.

- Step 1:** Place your Ultra PoE Gigabit Switch on a hard flat surface, with the front panel positioned towards your front side.
- Step 2:** Attach a rack-mount bracket to each side of the Ultra PoE Gigabit Switch with supplied screws attached to the package. Figure 3 shows how to attach brackets to one side of the Ultra PoE Gigabit Switch.

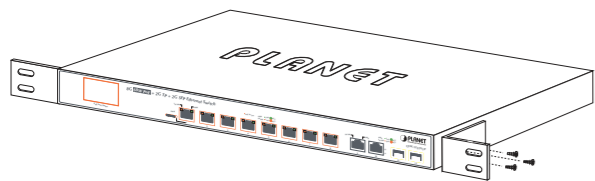

Figure 3: Attaching the Brackets to the Ultra PoE Gigabit Switch



You must use the screws supplied with the mounting brackets. Damage caused to the parts by using incorrect screws would invalidate the warranty.

- Step 3:** Secure the brackets tightly.
- Step 4:** Follow the same steps to attach the second bracket to the opposite side.
- Step 5:** After the brackets are attached to the Ultra PoE Gigabit Switch, use suitable screws to securely attach the brackets to the rack, as shown in Figure 4.

- 10 -

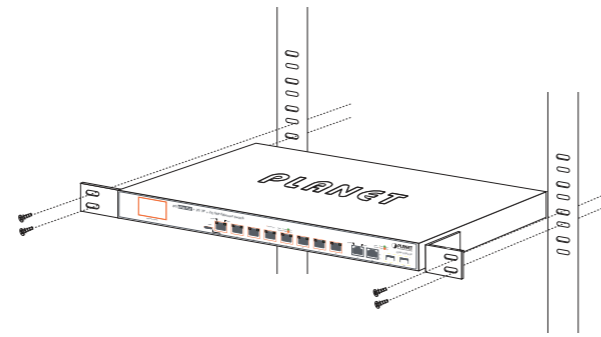

Figure 4: Mounting the Ultra PoE Gigabit Switch in a Rack

Step 6: Connect your Ultra PoE Gigabit Switch to 802.3af/802.3at/ Ultra PoE complied Power Devices (PD) and other network devices.

- A.** Connect one end of a standard network cable to the 10/100/1000BASE-T RJ45 ports on the front panel of the Ultra PoE Gigabit Switch.
- B.** Connect the other end of the cable to the network devices such as printer servers, workstations or routers, etc.

Step 7: Supply power to the Ultra PoE Gigabit Switch.

- A.** Connect one end of the power cable to the Ultra PoE Gigabit Switch.
- B.** Connect the power plug of the power cable to a standard wall outlet.

When the Ultra PoE Gigabit Switch receives power, the Power LED should remain solid Green.

- 11 -

Installing the SFP Transceiver

The sections describe how to insert an SFP transceiver into an SFP slot of the Ultra PoE Gigabit Switch.

The SFP transceivers are hot-pluggable and hot-swappable. You can plug in and out the transceiver to/from any SFP port without having to power down the Ultra PoE Gigabit Switch, as the Figure 5 shows.

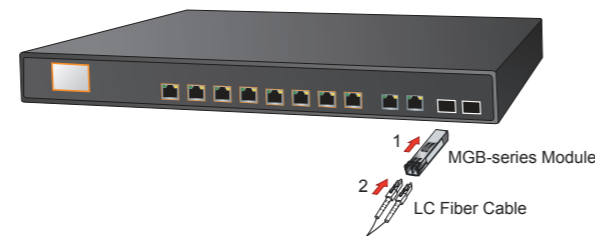

Figure 5: Plug In the SFP Transceiver

Approved PLANET SFP Transceivers

PLANET Ultra PoE Gigabit Switch supports both single mode and multi-mode SFP transceiver. The following website link of approved PLANET SFP transceivers is correct at the time of publication: <http://www.planet.com.tw/en/product/product.php?id=11027>



It is recommended to use PLANET SFP on the Ultra PoE Gigabit Switch. If you insert an SFP transceiver that is not supported, the Ultra PoE Gigabit Switch will not recognize it.

- 12 -

www.PLANET.com.tw

PoE Switch
GSW-1222VUP

8-Port Gigabit Ultra PoE
+ 4-Port Gigabit Ethernet Switch



PLANET Technology Corp.
11F., No. 96, Minquan Rd., Xindian Dist., New Taipei City 231, Taiwan



Energy Saving Note of the Device

This power required device does not support Standby mode operation. For energy saving, please remove the power cable to disconnect the device from the power circuit. Without removing power cable, the device will still consume power from the power source. In view of Saving the Energy and reducing the unnecessary power consumption, it is strongly suggested to remove the power connection for the device if this device is not intended to be active.

2351-AK5060-000



- Before we connect the Ultra PoE Gigabit Switch to the other network device, we have to make sure both sides of the SFP transceivers are with the same media type, for example, 1000BASE-SX to 1000BASE-SX; 1000BASE-LX to 1000BASE-LX.
- Check whether the fiber-optic cable type matches with the SFP transceiver requirement.
 - To connect to 1000BASE-SX SFP transceiver, please use the multi-mode fiber cable with one side being the male duplex LC connector type.
 - To connect to 1000BASE-LX SFP transceiver, please use the single-mode fiber cable with one side being the male duplex LC connector type.

Customer Support

Thank you for purchasing PLANET products. You can browse our online FAQ resource on PLANET Web site first to check if it could solve your issue. If you need more support information, please contact PLANET switch support team.

PLANET online FAQ : <http://www.planet.com.tw/en/support/faq.php?type=1>

Switch support team mail address: support_switch@planet.com.tw

Copyright © PLANET Technology Corp. 2016
Contents are subject to revision without prior notice.
PLANET is a registered trademark of PLANET Technology Corp. All other trademarks belong to their respective owners.

- 13 -



EC Declaration of Conformity

For the following equipment:

*Type of Product : 8-Port 10/100/1000T Ultra PoE + 2-Port 10/100/1000T + 2-Port 1000X SFP Gigabit Ethernet Switch

*Model Number : GSW-1222VUP

* Produced by:
Manufacturer's Name : Planet Technology Corp.
Manufacturer's Address : 10F., No.96, Minquan Rd., Xindian Dist., New Taipei City 231, Taiwan (R.O.C.)

is herewith confirmed to comply with the requirements set out in the Council Directive on the Approximation of the Laws of the Member States relating to Electromagnetic Compatibility Directive on (2014/30/EU) and Low Voltage Directive 2014/35/EU.

For the evaluation regarding the EMC, the following standards were applied:

EN 55022	(2010/AC: 2011)
EN 61000-3-2	(2014)
EN 61000-3-3	(2013)
EN 55024	(2010)
EN60950-1	(2006+A11:2009+A1:2010+A12:2011+A2: 2013)

Responsible for marking this declaration if the:

Manufacturer Authorized representative established within the EU

Authorized representative established within the EU (if applicable):

Company Name: Planet Technology Corp.

Company Address: 10F., No.96, Minquan Rd., Xindian Dist., New Taipei City 231, Taiwan (R.O.C.)

Person responsible for making this declaration

Name, Surname: Kent Kang

Position / Title: Director

Taiwan
Place

8th July 2016
Date

Kent Kang
Legal Signature

PLANET TECHNOLOGY CORPORATION

e-mail: sales@planet.com.tw <http://www.planet.com.tw>
10F., No.96, Minquan Rd., Xindian Dist., New Taipei City, Taiwan, R.O.C. Tel:886-2-2219-9518 Fax:886-2-2219-9528

- 10 -