

User's Manual

5 Mega-pixel Vandalproof IR PoE IP Camera with Extended Support

▶ ICA-E5550V



Copyright

Copyright © 2015 by PLANET Technology Corp. All rights reserved. No part of this publication may be reproduced, transmitted, transcribed, stored in a retrieval system, or translated into any language or computer language, in any form or by any means, electronic, mechanical, magnetic, optical, chemical, manual or otherwise, without the prior written permission of PLANET.

PLANET makes no representations or warranties, either expressed or implied, with respect to the contents hereof and specifically disclaims any warranties, merchantability or fitness for any particular purpose. Any software described in this manual is sold or licensed "as is". Should the programs prove defective following their purchase, the buyer (and not PLANET, its distributor, or its dealer) assumes the entire cost of all necessary servicing, repair, and any incidental or consequential damages resulting from any defect in the software. Further, PLANET reserves the right to revise this publication and to make changes from time to time in the contents hereof without obligation to notify any person of such revision or changes.

All brand and product names mentioned in this manual are trademarks and/or registered trademarks of their respective holders.

Federal Communication Commission Interference Statement

This equipment has been tested and found to comply with the limits for a Class B digital device, pursuant to Part 15 of FCC Rules. These limits are designed to provide reasonable protection against harmful interference in a residential installation. This equipment generates, uses, and can radiate radio frequency energy and, if not installed and used in accordance with the instructions, may cause harmful interference to radio communications. However, there is no guarantee that interference will not occur in a particular installation. If this equipment does cause harmful interference to radio or television reception, which can be determined by turning the equipment off and on, the user is encouraged to try to correct the interference by one or more of the following measures:

1. Reorient or relocate the receiving antenna.
2. Increase the separation between the equipment and receiver.
3. Connect the equipment into an outlet on a circuit different from that to which the receiver is connected.
4. Consult the dealer or an experienced radio technician for help.

FCC Caution

To assure continued compliance, for example, use only shielded interface cables when connecting to computer or peripheral devices. Any changes or modifications not expressly approved by the party responsible for compliance could void the user's authority to operate the equipment.

This device complies with Part 15 of the FCC Rules. Operation is subject to the following two conditions: (1) This device may not cause harmful interference, and (2) this device must accept any interference received, including interference that may cause undesired operation.

Federal Communication Commission (FCC) Radiation Exposure Statement

This equipment complies with FCC radiation exposure set forth for an uncontrolled environment. In order to avoid the possibility of exceeding the FCC radio frequency exposure limits, human proximity to the antenna shall not be less than 20 cm (8 inches) during normal operation.

Safety

This equipment is designed with the utmost care for the safety of those who install and use it.

However, special attention must be paid to the dangers of electric shock and static electricity when working with electrical equipment. All guidelines of this and of the computer manufacture must therefore be allowed at all times to ensure the safe use of the equipment.

CE Mark Warning

This is a Class B product. In a domestic environment, this product may cause radio interference, in which case the user may be required to take adequate measures.

WEEE Regulation



To avoid the potential effects on the environment and human health as a result of the presence of hazardous substances in electrical and electronic equipment, end users of electrical and electronic equipment should understand the meaning of the crossed-out wheeled bin symbol. Do not dispose of WEEE as unsorted municipal waste; they should be collected separately.

Revision

User's Manual of PLANET 5 Mega-pixel Vandalproof IR PoE IP Camera
Model: ICA-E5550V
Rev: 1.00 (July, 2015)
Part No. EM-ICAE5550V

Table of Contents

Chapter 1. Product Introduction	6
1.1 Package Contents.....	6
1.2 Overview.....	6
1.3 Features.....	10
1.4 Product Specifications.....	11
Chapter 2. Hardware Interface.....	13
2.1 Physical Descriptions.....	13
2.1.1 Identification of ICA-E5550V connectors	13
2.1.2 I/O Control Instruction.....	13
2.2 Hardware Installation	15
2.3 Initial Utility Installation.....	16
2.4 Using UPnP of Windows XP or 7	18
2.4.1 Windows XP	18
2.4.2 Windows 7	22
2.5 Setting Up ActiveX for Internet Camera	24
2.5.1 Internet Explorer 6 for Windows XP	25
2.5.2 Internet Explorer 7 for Windows XP.....	26
2.5.3 Internet Explorer 7 for Windows Vista.....	27
Chapter 3. Web-based Management.....	28
3.1. Introduction	28
3.2. Connecting to Internet Camera.....	28
3.3 Live Viewing.....	29
3.4 Configuration	31
3.5 Host Setup	31
3.5.1 Host	31
3.5.2 GPS Position	32
3.6 Date and Time	32
3.7 Network.....	34
3.7.1 IP Address Filtering.....	34
3.7.2 Port Mapping	35
3.7.3 HTTPS.....	36
3.7.4 IEEE802.1X	37
3.7.5 SNMP Setting	38
3.7.6 RTP	40
3.7.7 Network	41
3.8 IP Settings	43
3.8.1 Connection Type.....	43
3.8.2 DNS	44
3.8.3 DDNS & P2P	45
3.9 Video & Audio	46
3.9.1 Camera Options.....	47
3.9.2 Video	47
3.9.3 Audio.....	61
3.10 Event.....	61
3.10.1 Event Server	62
3.10.2 Event Configuration	64
3.10.3 Event List.....	70
3.10.4 Manual Event.....	73

3.11 System	73
3.11.1 User Account.....	73
3.11.2 System Info.....	75
3.11.3 Factory Default.....	75
3.11.4 Firmware Upload.....	76
3.11.5 Save & Reboot.....	76
3.11.6 Logout.....	76
Appendix A. Factory Default.....	77
Appendix B. Ping IP Address.....	78
Appendix C. Planet DDNS Application.....	79
Appendix D. Configuring Port Forwarding Manually	80

Chapter 1. Product Introduction

1.1 Package Contents

The package should contain the following items:

- Camera Unit x 1
- Quick Installation Guide x 1
- Mounting Screw Kit x 1
- Cable Gland x 2
- Terminal Block x 1
- Screw Torx x 1
- Mounting Diagram x 1

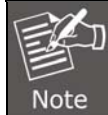

1. If any of the above items are missing, please contact your dealer immediately.
2. Using the power supply that is not the one included in the Internet Camera packet will cause damage and void the warranty for this product.

1.2 Overview

Extended Support with Specific Software

PLANET E-series of IP cameras, ICA-E5550V and ICA-E5550V, are able to provide advanced surveillance monitoring applications with specific software such as video analyzing and vehicle license plate recognition. Firstly, through CV7L PC-based software, it can help users monitor and record images/videos from multiple cameras simultaneously by using a single PC and able to operate up to 16 channels with advanced features including event management and recording, tri-display monitoring, smart motion detection, PTZ control and E-map. Secondly, PLANET E-series of IP cameras support the CV7-VA, a software of video analytics that is designed to transform your video surveillance network into a smart detection system. The software provides Entering Area, People Counting, Missing Object, Line Crossing, Unattended Object and Tamper functions. Once a suspicious activity is detected, users can playback to watch these events and use them as references or evidences if needed. Moreover, the cameras also support the CV7-LP video analytics software that is designed to detect and recognize vehicle license plates. This software is able to automatically locate and read license plates appearing in a certain area, and match this data against the database. It provides efficiency in parking and traffic control, as well as law enforcement.

Extended Support with Specific Software

Intelligent Management

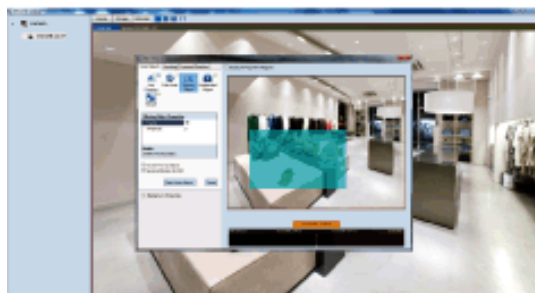

CV7-VA Software

Vehicle License Plate Recognition



CV7-LP Software

Professional, High Resolution, Day and Night Network Camera

PLANET ICA-E5550V Network Camera with IR Illuminator is a high resolution camera for the round-the-clock surveillance over IP networks. This camera supports H.264 and MJPEG compression formats and delivers excellent picture quality in 5 mega-pixel resolutions at 15 frames per second (fps) and full HD resolutions at 30fps. The ICA-E5550V is also equipped with IP66-rated and IK-10 vandalproof housing to protect the camera body against rain and dust and ensures operation under extreme weather conditions, which makes it an ideal solution for outdoor applications, e.g. surveillance of buildings, roads, parking areas, garages, railway stations, and airports.

5 Mega-pixel Resolution



Day & Night Functionality

To adapt to constantly changing lighting conditions during the day and night, the ICA-E5550V comes with a removable IR-cut filter and built-in IR illuminators, which enable the camera to provide color video when there is sufficient light, and black/white video in dark conditions. The ICA-E5550V is able to maintain clear images 24 hours a day.



Exceptional Image Quality

Together with powerful image processing attributes like Wide Dynamic Range (WDR) and 3-dimensional Noise Reduction (3DNR) technology, the ICA-E5550V is able to filter the intense backlight surrounding a subject and remove noises from video signal. The result is that an extremely clear and exquisite picture quality can be produced even under any challenging lighting conditions.



Advanced Event Management

The ICA-E5550V supports a number of advanced features to enhance surveillance flexibility and event management capabilities. The advanced features include 4 configurable regions of privacy mask to protect personal privacy, AV out for two-way audio function, and inputs/outputs for connecting to external devices such as door sensors and relays to activate light or close doors.



Flexible Installation and Power Functionality

The ICA-E5550V incorporates IEEE 802.3af Power over Ethernet technology and can be powered from a PoE sourcing equipment via the network, which eliminates the need for power cables and reduces installation costs. The ICA-E5550V is ONVIF-compliant and therefore interoperable with other brands in the market, greatly supporting users to integrate with their existing surveillance network. In addition, the ICA-E5550V includes 16-Ch video management software for efficient monitoring. The ICA-E5550V is indisputably the top choice for reliable and high performance surveillance.



1.3 Features

➤ Camera

- 1/3.2" 5MP progressive scan CMOS sensor
- 2.8~12 mm vari-focal, fixed-iris lens
- 0.1 lux minimum illumination at F1.4
- Maximum resolution 2592 x 1944
- Removable IR-cut filter for Day & Night function

➤ Video/Audio

- H.264/M-JPEG video compression
- Simultaneous multi-stream support
- H.264 high profile, main profile and baseline
- Max. resolution of 1080p at 30fps and 5 mega-pixel at 15fps
- 3DNR to improve picture quality at low lux
- WDR enhancement function strengthens visibility under extremely bright or dark environments
- Two-way audio support with enhanced audio quality

➤ Network and Configuration

- Compliant with IEEE 802.3af PoE interface for flexible deployment
- Supports both IPv6 and IPv4 protocols
- RTSP, UPnP, Bonjour, HTTPS protocols selectable

➤ Easy Installation & Management

- ONVIF compliant for interoperability
- Built-in 15 IR Illuminators, effective up to 30 meters
- IK-10/IP66 classification with vandal and weather proof
- Micro SD card local video recording supported
- Digital Input/Output for integration with sensors and alarms
- Cam viewer E-series software supported – CV7L, CV7-VA, CV7-LP

1.4 Product Specifications

Model	ICA-E5550V
Camera	
Image Device	1/3.2" 5 mega-pixel progressive scan CMOS Sensor
Lens	Vari-focal 2.8~12 mm, fixed-iris Mechanical IR-cut filter Angle of view: Horizontal: 28.2~69.2 degrees
Min Illuminator	0.1 lux @ F1.4
IR Illumination LED	IR LED*15, 850nm Built-in IR illuminators, effective up to 30 meters
Effective Pixels	2592 x 1944 pixels
Image	
Video Encoder	H.264/MJPEG
Video Profile	H.264: 2592 x 1944, 2048 x 1536, 1920 x 1080, 1280 x 720, 800 x 600, 640 x 480 MJPEG: 2592 x 1944, 2048 x 1536, 1920 x 1080, 1280 x 720, 800 x 600, 640 x 480
Frame Rate	5MP up to 15fps Full HD up to 30fps
Image Setting	Video Flipping, Video Mirroring, Brightness, Contrast, 3DNR, WDR (74dB)
Streaming	Simultaneous dual streams based on two configurations Controllable frame rate and bandwidth Constant and variable bit rate
Audio	
Compression	8kHz, Mono, PCM, 16-bit encoding; G.711
Audio Input	Terminal block
Audio Output	Terminal block
Network and Configuration	
Network Standard	IEEE 802.3 10BASE-T IEEE 802.3u 100BASE-TX
Supported Protocols	TCP, UDP, HTTP, HTTPs, DHCP, PPPoE, RTP, RTSP, IPv6, DNS, PLANET DDNS, PLANET Easy DDNS, NTP, ICMP, ARP, IGMP, SMTP, FTP, UPnP, SNMP, Bonjour
Security	Password protection, IP address filtering, HTTPS encryption, anonymous login, 802.1X network access control

Users	10 simultaneous unicast users
System Integration	
Application Programming Interface	Software Development Kit (SDK) available; ONVIF compliant
Alarm Triggering	Video motion detection (3 regions)
Alarm Events	Notify control center; Change camera settings; Command other devices; E-mail notification with snapshots; Save video or snapshot to local storage; Upload video and snapshot to FTP server; Activate external device through digital output
General	
Power Supply	PoE Class 2 (IEEE 802.3af)
Power Consumption	PoE: 6.49W (IR on)
Housing	IK-10 / IP66 classification with vandal and weather proof
Operating Temperature	-40 ~ 50 degrees C
Operating Humidity	10 ~ 85% (non-condensing)
Weight	1032g
Dimensions (Φ x L)	150 x 116 mm
Emission	CE, FCC
Connectors	10/100Mbps Ethernet, RJ45 Reset button Digital Input (1, Terminal block) Digital Output (1, Terminal block) Micro SDHC, Micro SDXC card slot (max. 32GB, class 10)

Chapter 2. Hardware Interface

2.1 Physical Descriptions

2.1.1 Identification of ICA-E5550V connectors

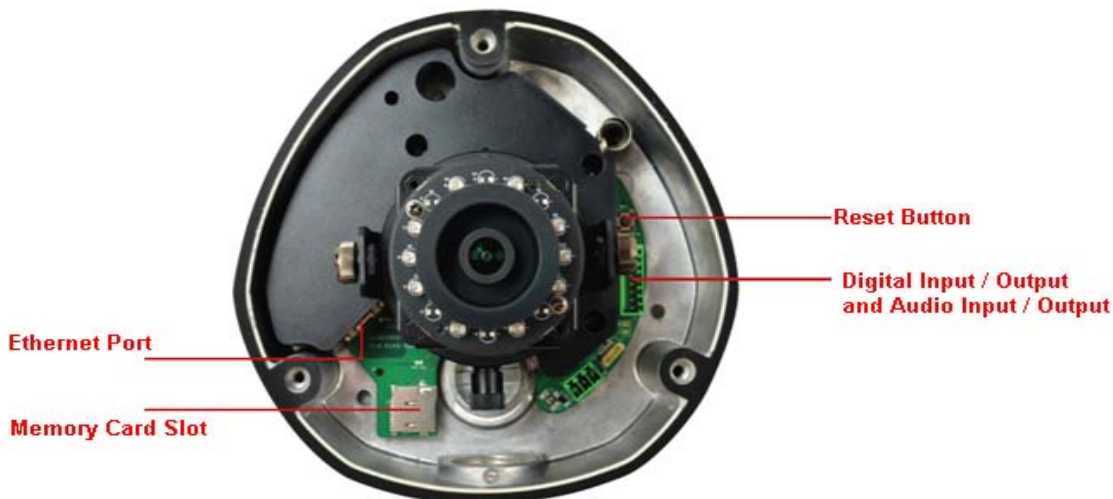

1. Memory Card Slot: Support microSDHC and microSDXC cards. Insert a memory card (not included) into this slot for local recording purposes.

2. Reset Button: Use the Reset Button to reset the camera to its factory default settings. To do the reset, press and hold the Reset button for at least 5 seconds or until the Power LED lights up. When the Power LED lights up again, reset is complete.

3. DI/DO
Depending on your surveillance needs, you may connect digital input / output or audio input / output devices to your camera. The camera comes with one terminal block for both digital and audio input/output devices..

4. Ethernet Port
Connect to a network using a standard Ethernet cable.

2.1.2 I/O Control Instruction

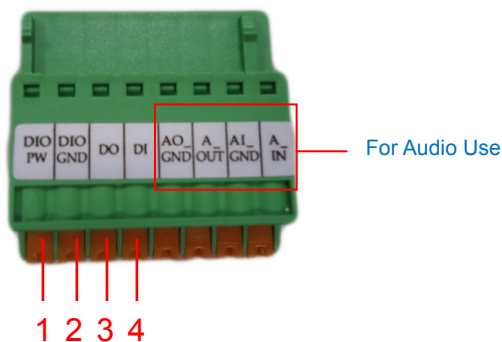

1) Identification

Device	Pin		Mapping Instructions
Digital Output (DO)	1	DIO PW	Connect the wires of the output device to DIO PW (Pin 1) and DO (Pin 3).
	3	DO	
Digital Input (DI)	2	DIO GND	Connect the wires of the input device to DIO GND (Pin 2) and DI (Pin 4).
	4	DI	

2) DI/DO Connection Specification

Device			
DI	Connection Design		TTL - compatible logic levels
	Voltage	To trigger	Logic level 0: 0V ~ 0.4V
		Normal	Logic level 1: 3.1V ~ 30V
Current	10mA ~ 100mA		
DO	Connection Design		Transistor (Open Collector)
	Voltage & Current		< 24V DC, < 50mA

3) Typical Connection

Based on these specifications, if the DI device has a voltage of 0V ~ 30V or the DO device has a voltage of < 24V (< 50mA), then the camera can supply internal power to these devices and there is no need to connect the DI/DO device to an external power source.

In this case, wire connection to Pins 1 to 4. Use the **DIO GND** and **DI** pins to connect a DI device and use the **DIO PW** and **DO** pins to connect a DO device. See wiring scheme below:

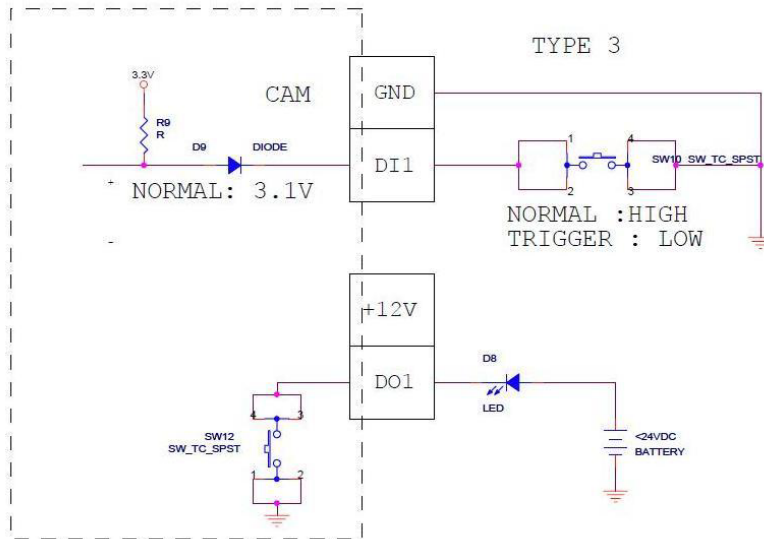

4) High Voltage DO Device Connection

Even though the camera provides 12V power, this may not be enough for some high voltage DO devices, such as a ceiling light or a motor that opens or closes a gate. In this case, there is a need to connect an external relay. See wiring scheme below:

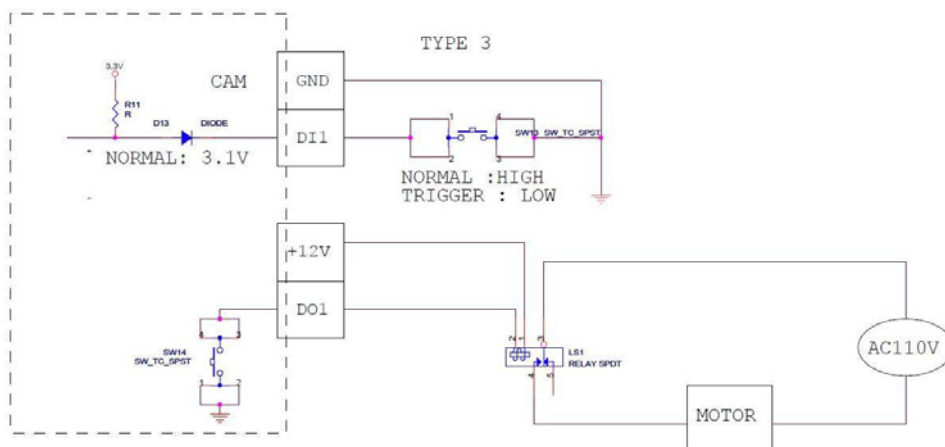

Note that when choosing an appropriate relay, please refer to its specifications and make sure they match the above design. The triggering circuit voltage has to be around 12V DC and the switch-controlled circuit voltage has to match the external power supply (e.g. 110V AC or 220V AC).

The illustration below is a graphic example of connecting a relay to a high voltage DO device.

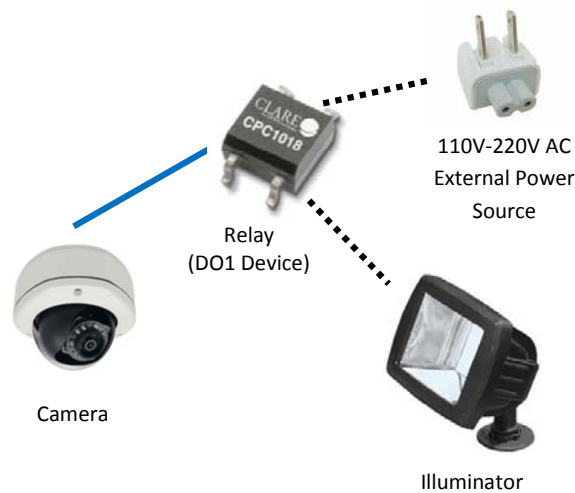

2.2 Hardware Installation

1. Place the Camera on the ceiling or fix it onto wall

Use mounting diagram to help you to drill the holes.

2. Plug an Ethernet cable into the Camera

Open dome cover and then connect an Ethernet cable to the LAN socket located on the Network Camera and attach it to the network.

3. Prepare for waterproof installation

- **Cable Gland:** For use with an **Exterior-grade Ethernet cable**. Exterior-grade Ethernet cables are already waterproof.
- **Conduit Gland:** For use with a flexible conduit. This solution is recommended when an exterior-grade Ethernet cable is not available or when other cable connections, like audio input, DC 12V power, etc. will be connected to the camera.

4. Done

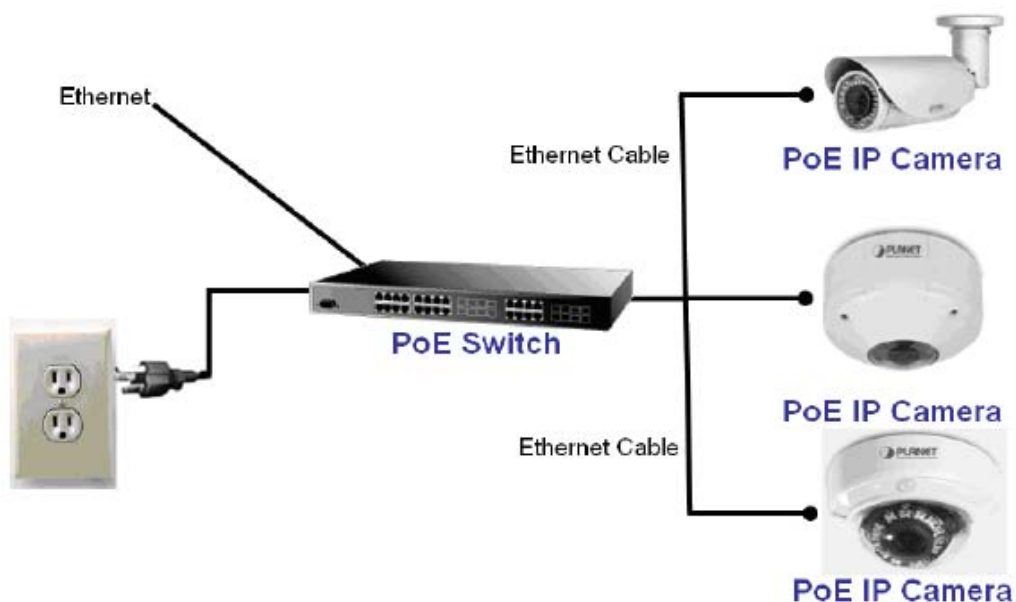

2.3 Initial Utility Installation

This chapter shows how to quickly set up your H.264 camera. The camera is with the default settings. However, to help you find the networked camera quickly the windows utility PLANET IP Utility can search the cameras in the network that will help you to configure some basic settings before you start advanced management and monitoring.

1. Go to PLANET website and look for the download function of the camera.
2. Put the "IP Utility" on a folder and then execute the program.
3. The GUI of IP Utility is as follows (Default IP: 192.168.0.20).

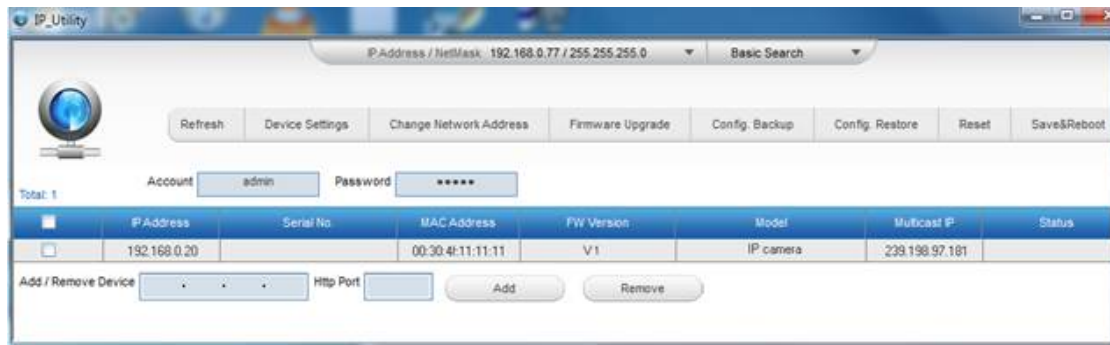

- (1) IP Utility will search all IP cameras connected to LAN. The user can click "**Refresh**" to search again.
- (2) Select one of IP cameras listed on the left side of IP Utility, and then click "**Change Network Address**" to change IP address. If parameters change, click on "**Apply**". Then, the network configuration will be changed.

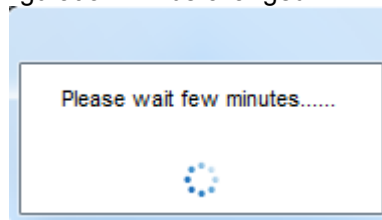

- (3) Please make sure the subnet of PC IP address and IP CAM IP address are the same.
IP CAM IP address: **192.168.0.20**
PC IP address: **192.168.0.100**
- (4) Different Subnets:
IP CAM IP address: **192.168.0.20**
PC IP address: **192.168.1.100**

- (5) To Change PC IP addresses:
Control Panel→Network Connections→Local Area Connection Properties→Internet Protocol (TCP/IP) →Properties
Please make sure your IP Camera and PC have the same Subnet. If not, please change IP Camera IP subnet or PC IP subnet accordingly.

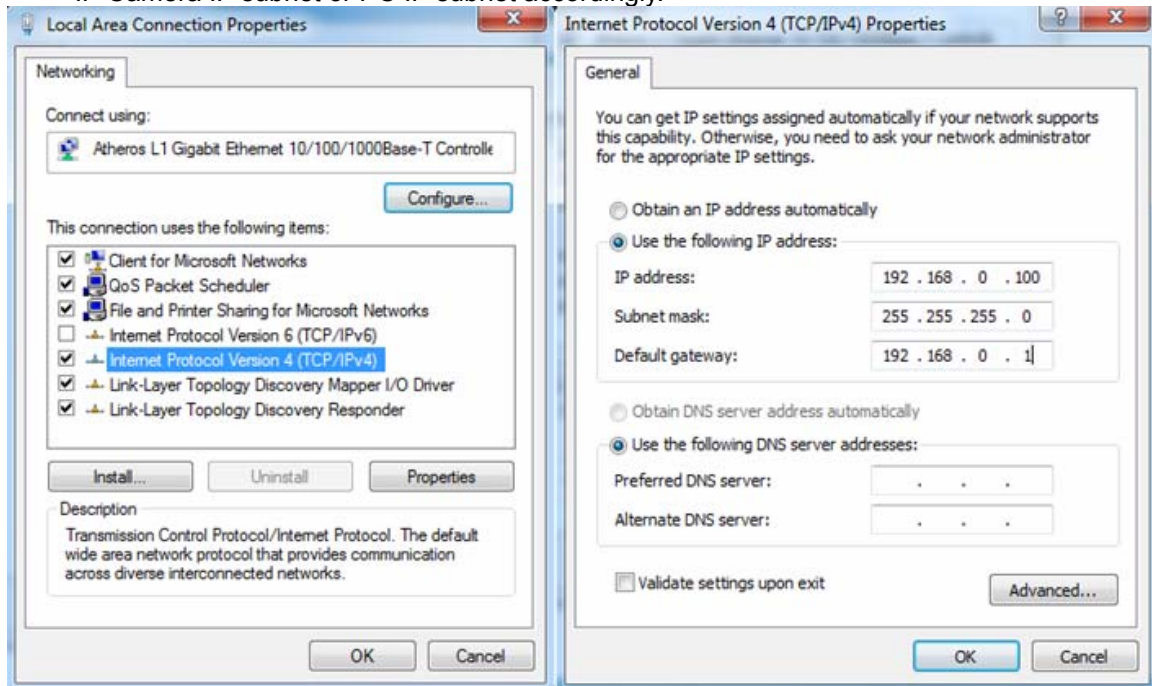

- (6) A quick way to access remote monitoring is to left-click the mouse twice on a selected IP camera listed on “Device list” of PLANET IP Utility. An IE browser will be opened.

- (7) Then, please key-in the default User Name “**admin**” and Password “**admin**” in the following window:

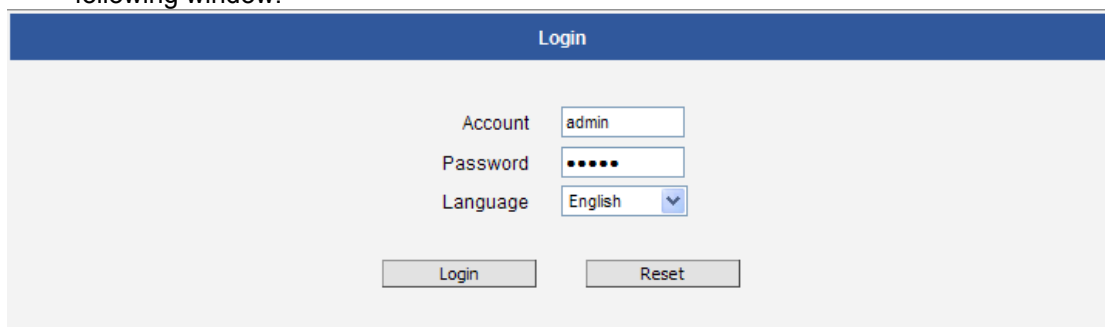

The image shows a 'Login' window with a blue header. It contains three input fields: 'Account' with the text 'admin', 'Password' with six dots, and 'Language' with a dropdown menu showing 'English'. At the bottom, there are two buttons: 'Login' and 'Reset'.

(8) If the user name and password are input correctly, the following web page will be displayed.



2.4 Using UPnP of Windows XP or 7

2.4.1 Windows XP

UPnP™ is short for Universal Plug and Play, which is a networking architecture that provides compatibility among networking equipment, software, and peripherals. This device is an UPnP enabled device. If the operating system, Windows XP, of your PC is UPnP enabled, the device will be very easy to configure. Use the following steps to enable UPnP settings only if your operating system of PC is running Windows XP.



Please note that MS Windows 2000 does not support UPnP feature.

Go to **Start > Settings**, and click **Control Panel**.

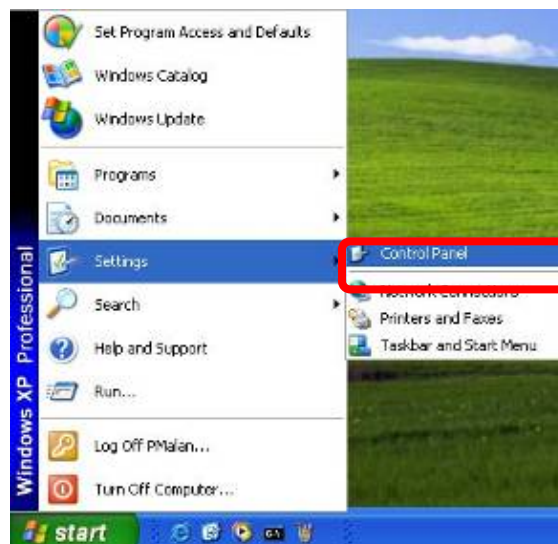

The “Control Panel” will be displayed on the screen and double-click “Add or Remove Programs” to continue.

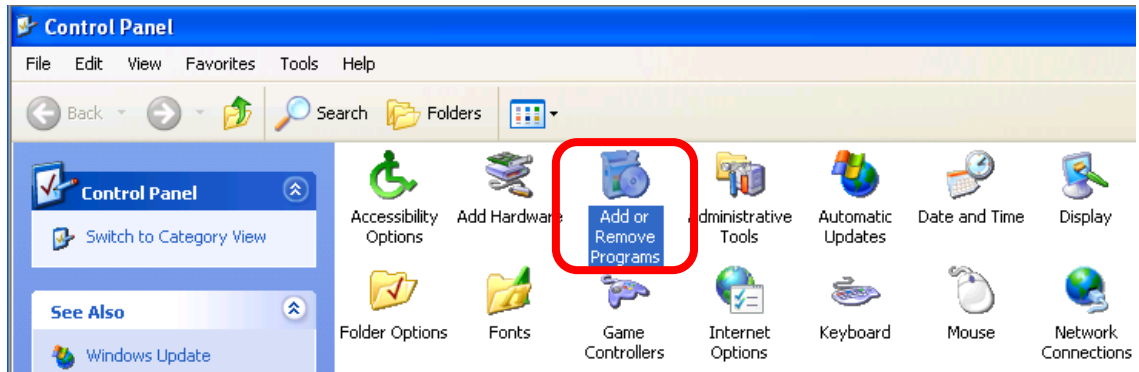

The “Add or Remove Programs” will display on the screen and click **Add/Remove Windows Components** to continue.

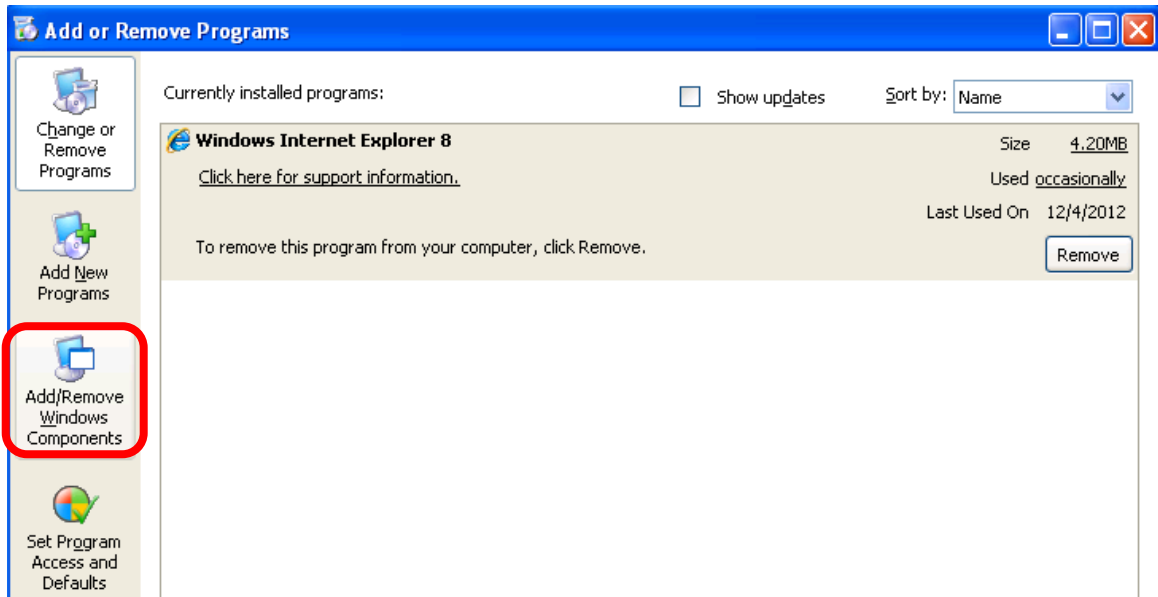

The following screen will appear; select “**Networking Services**” and click “**Details**” to continue.

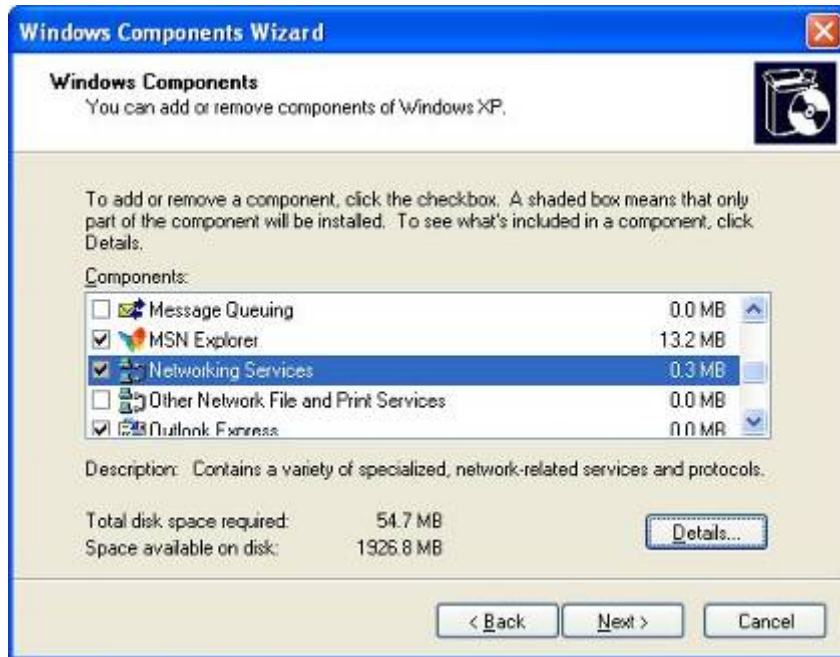

The “Networking Services” will be displayed on the screen; select “**Universal Plug and Play**” and click “**OK**” to continue.

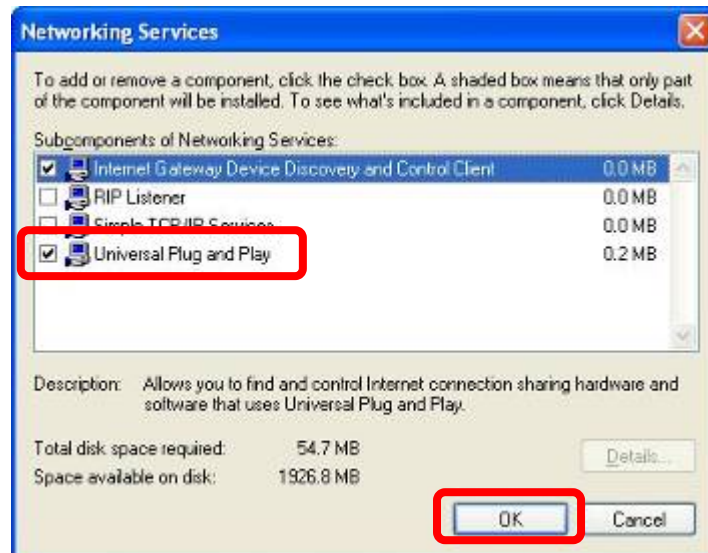

Please click “**Next**” to continue.



The program will start installing the UPnP automatically. You will see the pop-up screen as shown below. Please wait while Setup configures the components.

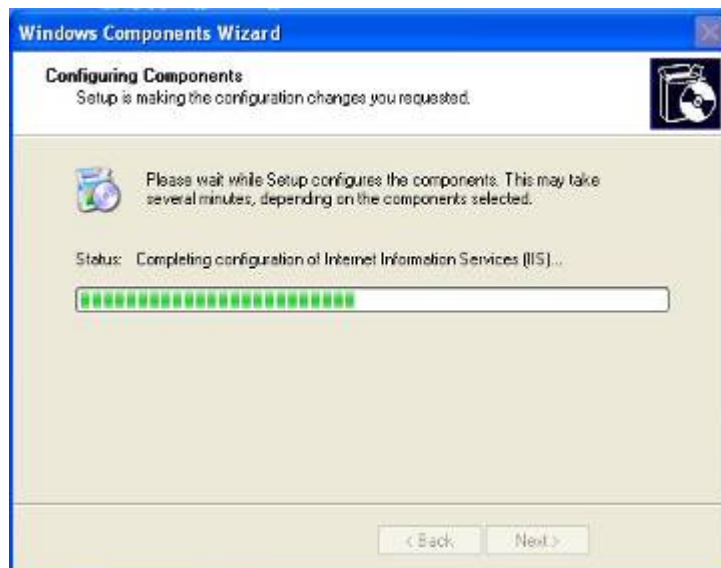

Please click **“Finish”** to complete the UPnP installation



Double-click **“My Network Places”** on the desktop; the “My Network Places” will be displayed on the screen and double-click the UPnP icon with Internet Camera to view your device in an Internet browser.

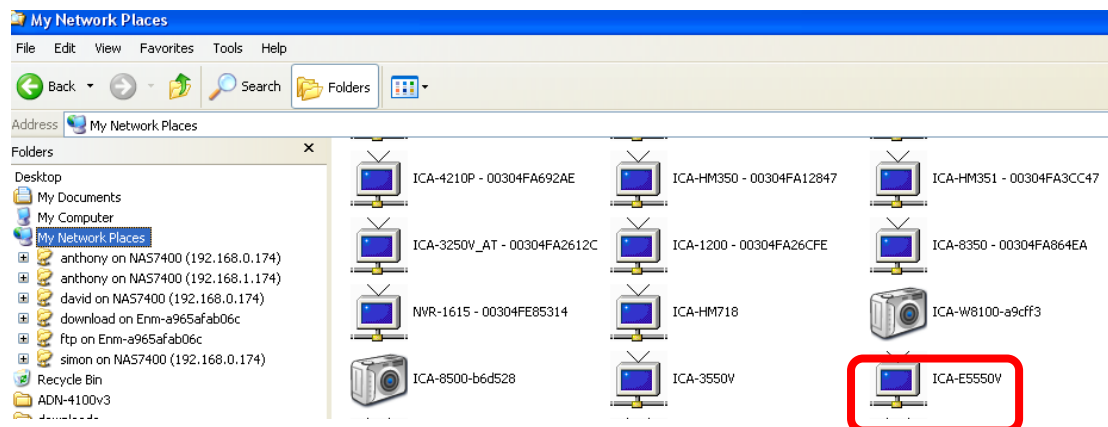

2.4.2 Windows 7

Go to **Start > Control Panel > Network and Internet > Network and Sharing Center**. If network discovery is off, click the arrow button  to expand the section.

Click Turn on network discovery, and then click Apply.  If you are prompted for an administrator password or confirmation, type the password or provide confirmation.

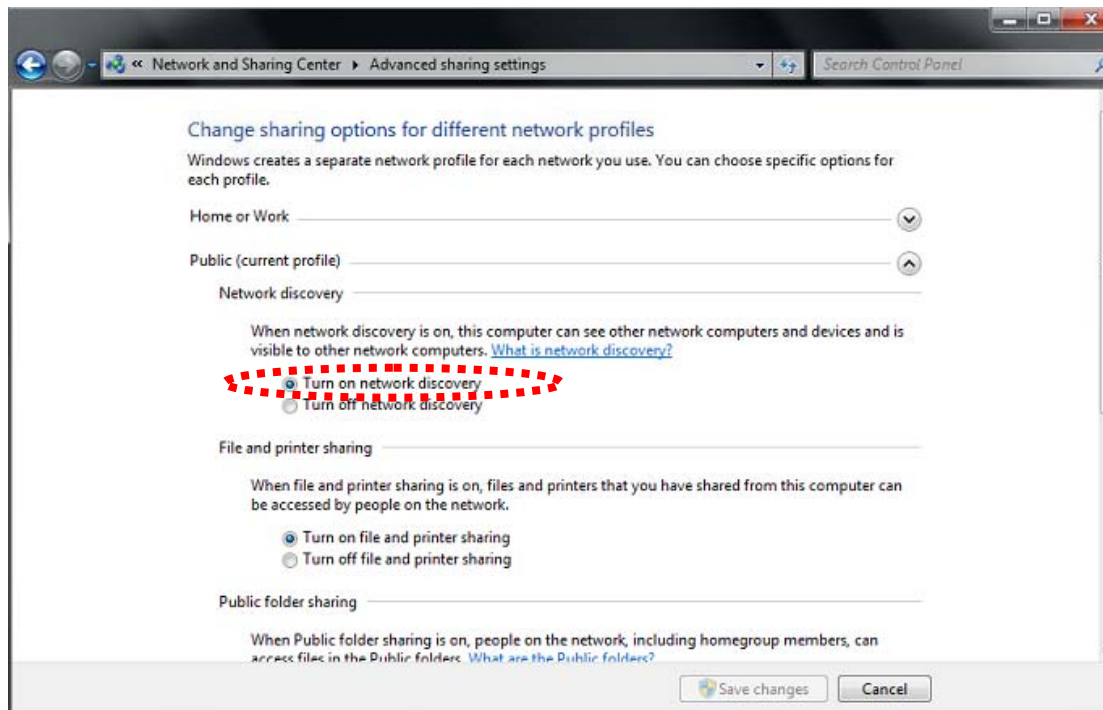
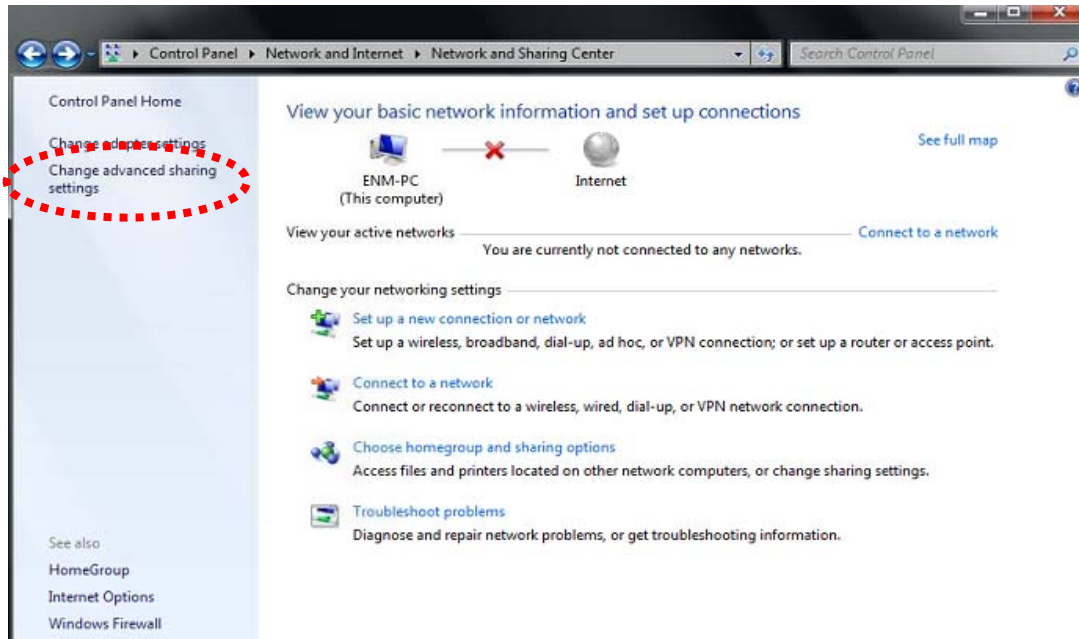

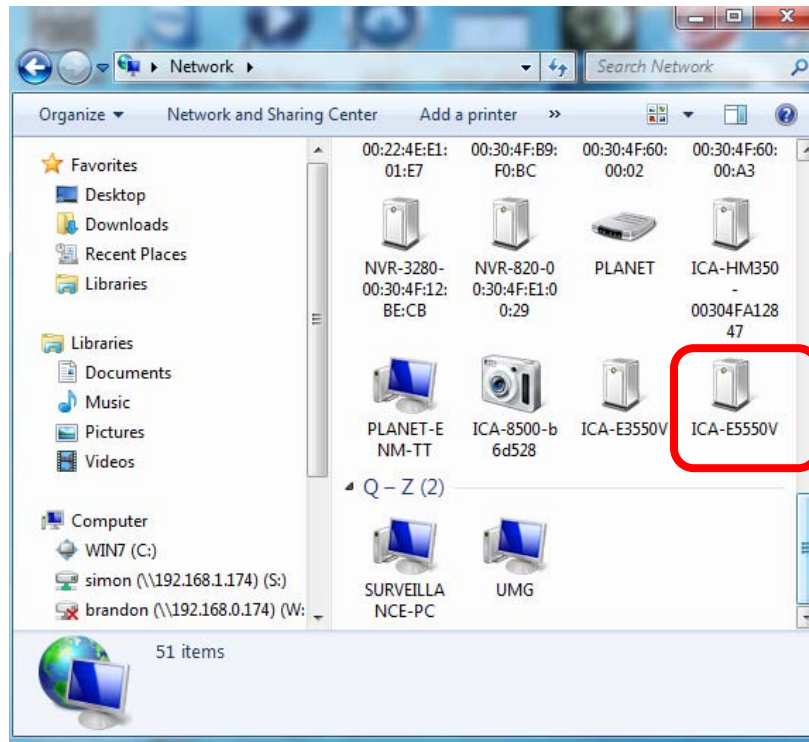

2.5 Setting Up ActiveX for Internet Camera

The Internet Camera web pages communicate with the Internet Camera using an ActiveX control. The ActiveX control must be downloaded from the Internet Camera and installed on your PC. Your Internet Explorer security settings must allow for the web page to work correctly. To use the Internet Camera, user must setup his IE browser as follows:

2.5.1 Internet Explorer 6 for Windows XP

From your IE browse → "Tools" → "Internet Options..." → "Security" → "Custom Level...", please set up your "Settings" as follows:

Set the first 3 items

- Download the signed ActiveX controls
- Download the unsigned ActiveX controls
- Initialize and script the ActiveX controls not masked as safe to Prompt

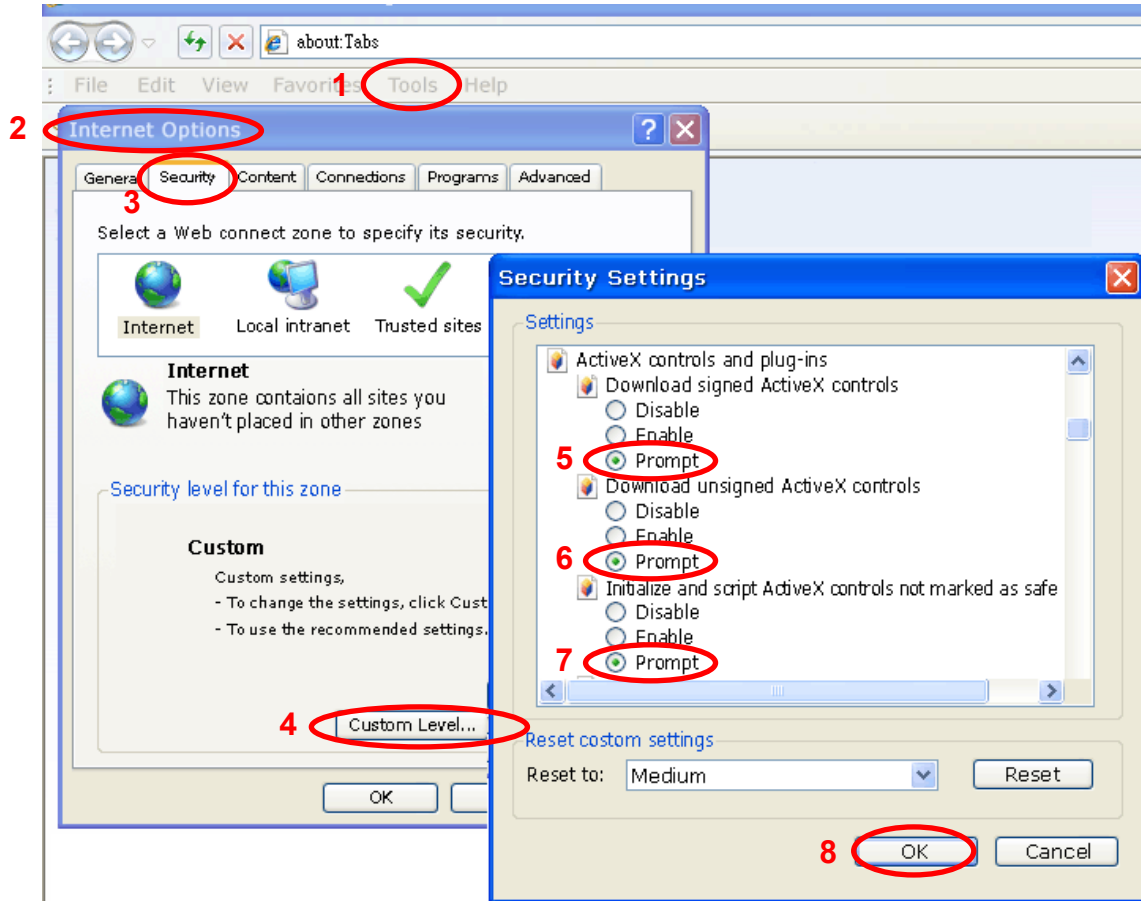

By now, you have finished your entire PC configuration for Internet Camera.

2.5.2 Internet Explorer 7 for Windows XP

From your IE browser → "Tools" → "Internet Options..." → "Security" → "Custom Level...", please set up your "Settings" as follows:

Set the first 3 items

- Allow previously unused ActiveX control to run...
- Allow Scriptlets
- Automatic prompting for ActiveX controls

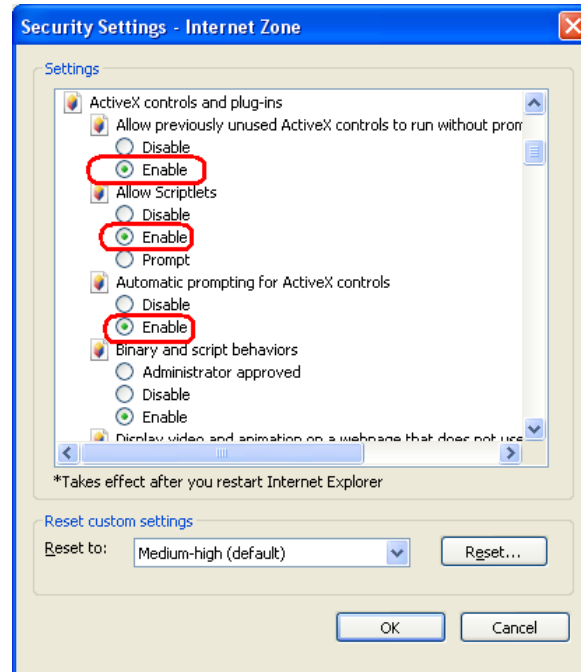

By now, you have finished your entire PC configuration for Internet Camera.

2.5.3 Internet Explorer 7 for Windows Vista

From your IE browser → "Tools" → "Internet Options..." → "Security" → "Internet" → "Custom Level...", please set up your "Settings" as follows:

- Enable "Automatic prompting for ActiveX controls"
- Prompt "Initialize and script active controls not marked..."

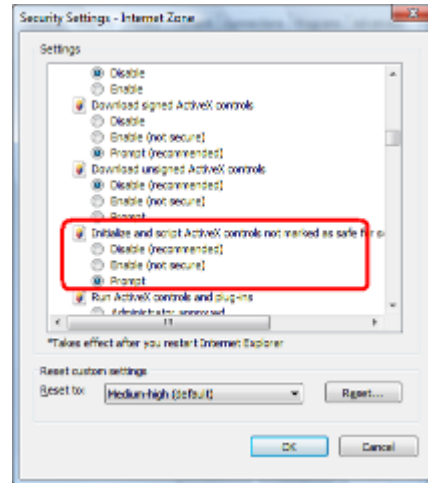
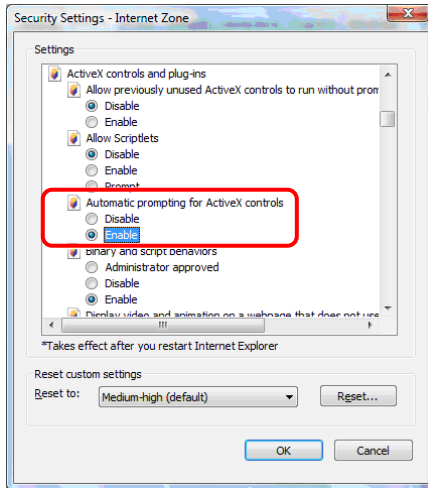

From your IE browse → "Tools" → "Internet Options..." → "Security" → "Trusted Sites" → "Custom Level...", please set up your "Settings" as follows:

- Enable "Automatic prompting for ActiveX controls"
- Prompt "Initialize and script active controls not marked..."

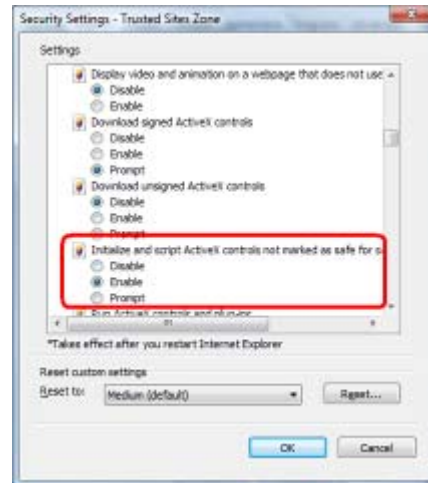
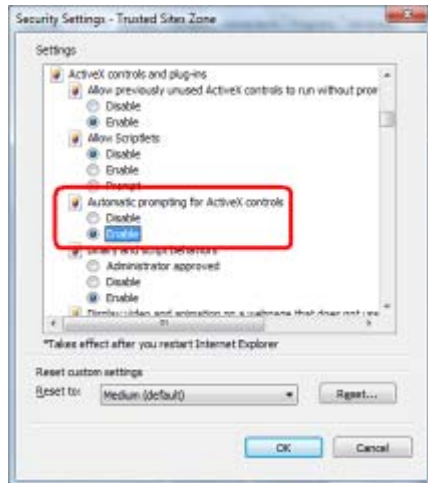

By now, you have finished your entire PC configuration for Internet Camera.

Chapter 3. Web-based Management

This chapter provides setup details of the Internet Camera's Web-based Interface.

3.1. Introduction

The Internet Camera can be configured with your Web browser. Before configuring, please make sure your PC is under the same IP segment as Internet Camera.

3.2. Connecting to Internet Camera

A. Use the following procedures to establish a connection from your PC to the Internet Camera.

B. Once the camera is connected, you can add the camera to your browser's Favorites or Bookmarks.

Start the web browser on the computer and type the IP address of the camera.

The default IP: "<http://192.168.0.20>"

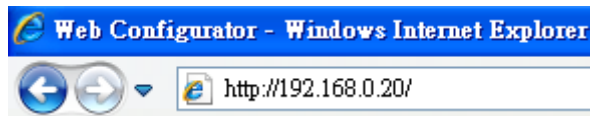

The login window of Internet Camera will appear,
Default login username and password are both **admin**.

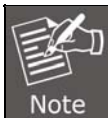
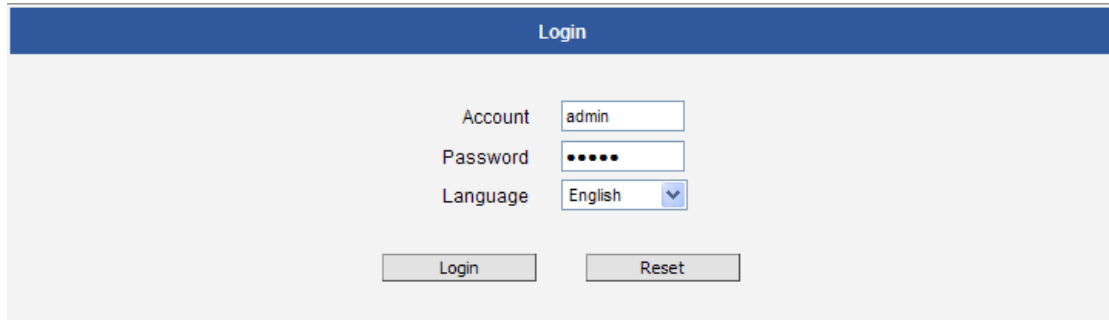

If the User Name and Password have been changed with PLANET IP Utility, please enter the new User Name and Password here.

After logging on, you should see the following messages at the bottom of Internet Explorer:
When you see this message, click **Allow** to install the required ActiveX control.

This webpage wants to run the following add-on: 'nvA1Media.ocx' from 'Global ISMP Corporation'. [What's the risk?](#)

Allow x

After the ActiveX control is installed and run, the first image will be displayed.



 **Note** If you log in the camera as an ordinary user, setting function will be not available. If you log in the camera as the administrator, you can perform all the settings provided within the device.



3.3 Live Viewing

The live view will appear automatically with the video resolution of 1280x720 (1MP cameras) or 1920x1080 (2-5MP cameras).



While being on the Live View page, the Live View icon appears as being pressed:
If you leave the Live View page, you can later return by pressing that button. The buttons shown on the Live View page vary depending on the functions supported by the camera.

If the resolution of the PC's monitor is bigger than the resolution of the live video, you will be able to see the whole size of the video immediately. If not, you will only see part of the video at first and you would have to use the scroll bars to see the rest of the video area. In order to see the whole video on your display, you can temporarily re-scale the video to better fit your screen by pressing the digital zoom buttons:

-  - Enlarge the video size digitally
-  - Reduce the video size digitally

Notice: These digital zoom adjustments do not influence the actual video resolution of the

camera. Regardless of how large or small the video appears on the display after pressing the digital zoom buttons, the actual video stream size of the camera is the same as before.

You can also digitally re-scale the video to fully match the size of your display with just 1 click:

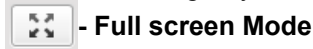

You may use **ESC** key from the keyboard to exit the full screen mode.

The cameras have the **dual stream** capability – **Stream 1** is usually the high resolution stream with the purpose of being recorded by NVR while **Stream 2** has lighter video configuration for NVR live view purposes, to reduce the computing power of the NVR PC. Both streams can be configured under Web Configurator's Setup page. To see how each of the stream looks like, there are quick buttons on the Live View page:



When pressing the Stream 2 button, the Live View would look like this:



To capture the snapshots of the current live view, press the snapshot button. The snapshots are saved in the Picture folder.

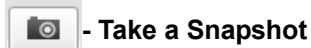





Cameras with audio function have the audio controls on Live View page.



To speak to the camera, press the  button. If the camera is connected to a network video recorder, the audio will be recorded with the video stream.

The digital output controls appear on the Live View page of the cameras with digital input/output function. The controls allow users to manually trigger a DO device.



Each DO port is controlled separately. For cameras with more than one DO port, select the DO port and press  to set the output power level to high or  to set the output power level to low. Consequently, setting the port to a high power level “activates” the DO device and setting the port to a low power level “deactivates” the DO device. For example, if an alarm is set as DO1 and  is pressed, the alarm will continuously sound until  is pressed to deactivate the device.

3.4 Configuration

To configure any of the camera settings, go to the Setup menu by pressing the following button on the Live View page:



The left side of the Setup page contains the list of Setup items.



The exact content of the menu list varies for each camera, depending on the actual capabilities of each camera. This manual, however, is designed to explain all the possible functions.

Several items in the Setup page are divided into groups, such as Network, IP Settings, etc. You can expand the groups to see the sub-items by pressing the [+] button.

The following chapters of this manual explain each Setup item separately. The chapters are listed in the same order as the list of Setup menu items.

3.5 Host Setup

The “Host Setup” section allows the administrator to define the name of the camera and preferred user interface language.

3.5.1 Host

Host

Host Name

Language ▼

Camera Name

Parameters	Description
Host Name	Host Name is used to identify the camera by a DHCP server. In some networks with very strict security policy, it is required that all the network devices should have their host name, and when the devices attempt to access the network by requesting an IP address from a DHCP server, the DHCP server would check if the host name is among the allowed devices. On this page, it is possible to edit the Host Name. To actually include the Host Name in DHCP discovery packet sent from a camera, please go to IP Settings and make sure the device is in Dynamic IP Address mode and “Use host name” is checked.
Language	Language selection under Host has the same purpose as the one on the login page of Web Configuration.
Camera Name	Camera Name is used to identify the device by Video Management System or by Software Tools. Usually, upon installation of the camera, the actual installation location is used as an easy-to-remember Camera Name, such

as “Front Gate” or “Elevator 1”. In many cases the VMS is able to modify the Camera Name directly via its own user interface without needing to access Web Configuration.

After changing any of the items above, press **Apply** to save the changes. The Reset button undoes the changes that had just been made but not Applied yet.

3.5.2 GPS Position

This section allows users to manually set the GPS position of the camera and find the location of the camera on the map when using a Network Video Recorder (NVR).

GPS Position

Enabled

Degree of Latitude

Degree of Longitude

Format of GPS Position : ddd.dddddd or -ddd.dddddd

Check the **Enabled** box to enable this feature.

Find the camera location on Google maps, for example, installed in the airport.

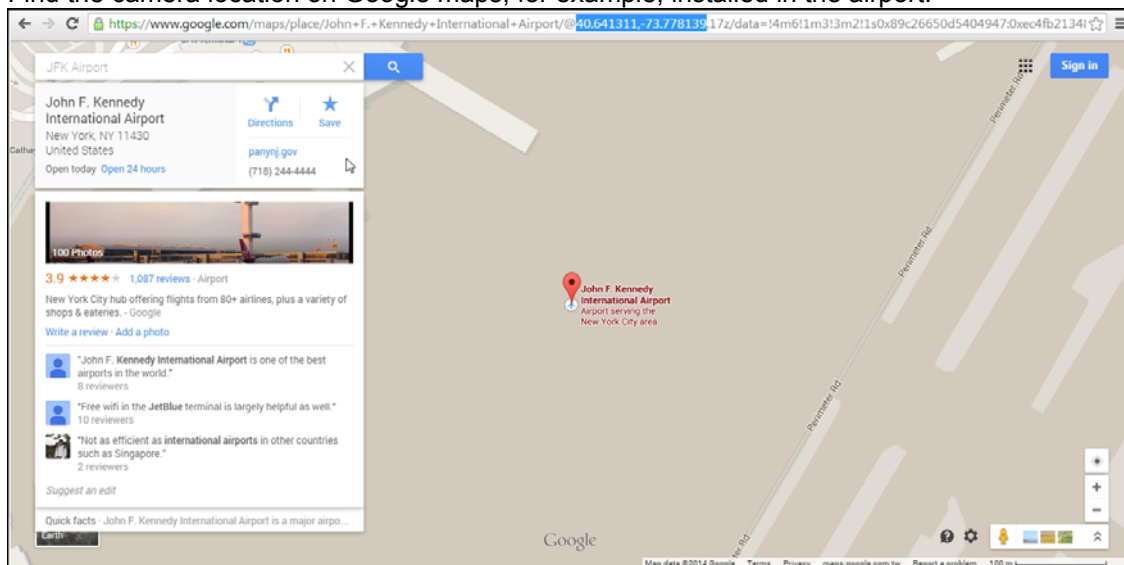

Copy the first GPS coordinates from the URL bar and paste it on **Degree of Latitude**. Copy the second part of the GPS coordinates to **Degree of Longitude**. Press **Apply** to save the changes.

3.6 Date and Time

Each video frame contains a time stamp. The accuracy of the time stamp is very important for incident investigators. Therefore the clock of the camera has to be adjusted to most accurate time possible.

The section **Date & Time** provides the options for adjusting the date and time of the camera.

There are two ways to adjust the date and time – **automatically** by getting date and time regularly from any of the **NTP servers** worldwide, or **manually** by selecting proper time zone,

date and time. The automatic way can be used only if the camera has an access to NTP servers. If you are using an isolated Local Area Network without Internet access, you can only use Manual date and time adjustment mode.

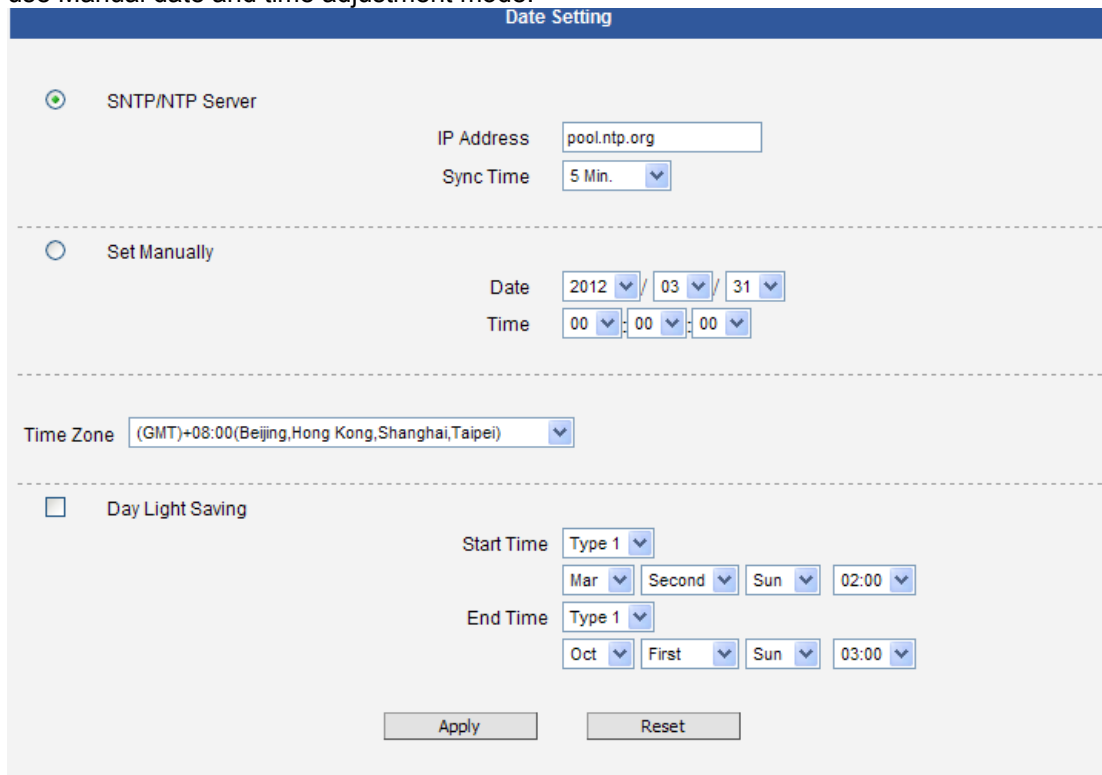

When choosing **SNTP/NTP Server** for automatic date and time updating, you can key-in the IP address of the NTP server and the time interval for automatic time synchronization. If you want to key-in the domain name of NTP server instead, please make sure the DNS server IP address has been set under IP Settings; otherwise, the camera will not be able to resolve the domain name of the NTP server.

If all the cameras are getting the date and time from the same NTP Server, you can be most sure that the video clips from different cameras can be well synchronized later for comparison purposes.

To choose the most suitable NTP Server to synchronize date and time with, please refer to the worldwide pool of NTP Servers: <http://www.pool.ntp.org/en/>

When choosing **Set Manually** mode, you can adjust the date and time by the select boxes. Choose the appropriate **Time Zone** from the select box, too. If your location is not listed there, then pick any of the listed zones which GMT is identical with your location.

For the countries with daylight saving policy, there is **Day Light Saving** function with two different types:

Type 1 – define the starting or ending time of daylight saving period by the **number of the week in the month** (First, Second, Third or Last week).

Type 2 – define the starting or ending time of daylight saving period by the **exact date in the month** (1-31).

Whether to choose Type 1 or Type 2, please refer to the daylight saving policy of given country.

After changing any of the items above, press Apply to save the changes. The Reset button undoes the changes that had just been made but not Applied yet.

3.7 Network

The section **Network** provides the list of network related functions and services. The [+] mark before Network indicates that the list can be expanded by clicking on it. Once expanded, the list can later be collapsed again by clicking on the [-] mark.

3.7.1 IP Address Filtering

By “**IP Address Filtering**” function it is possible to define which devices (their IP addresses) are allowed to connect to this camera, and which devices are forbidden to connect to this camera.

Check the box “Enabled” to activate the IP address filtering function and press Apply.



Below you can select either “Allowed” or “Blocked” list to add items there and Enable them with the checkbox behind each row.

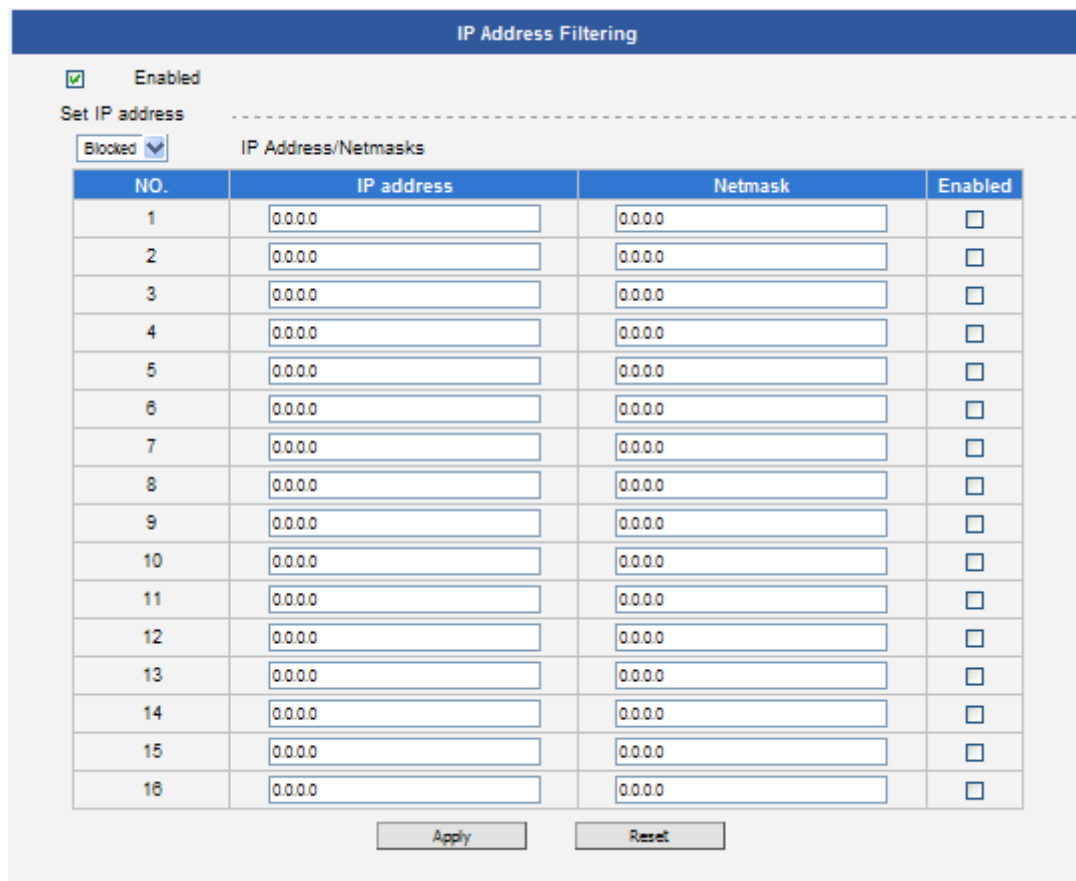

NO.	IP address	Netmask	Enabled
1	0.0.0.0	0.0.0.0	<input type="checkbox"/>
2	0.0.0.0	0.0.0.0	<input type="checkbox"/>
3	0.0.0.0	0.0.0.0	<input type="checkbox"/>
4	0.0.0.0	0.0.0.0	<input type="checkbox"/>
5	0.0.0.0	0.0.0.0	<input type="checkbox"/>
6	0.0.0.0	0.0.0.0	<input type="checkbox"/>
7	0.0.0.0	0.0.0.0	<input type="checkbox"/>
8	0.0.0.0	0.0.0.0	<input type="checkbox"/>
9	0.0.0.0	0.0.0.0	<input type="checkbox"/>
10	0.0.0.0	0.0.0.0	<input type="checkbox"/>
11	0.0.0.0	0.0.0.0	<input type="checkbox"/>
12	0.0.0.0	0.0.0.0	<input type="checkbox"/>
13	0.0.0.0	0.0.0.0	<input type="checkbox"/>
14	0.0.0.0	0.0.0.0	<input type="checkbox"/>
15	0.0.0.0	0.0.0.0	<input type="checkbox"/>
16	0.0.0.0	0.0.0.0	<input type="checkbox"/>

“**Allowed**” mode will refuse access to all IP addresses except the ones listed below.

“**Blocked**” mode will accept all incoming access except the IP addresses listed below.

Using **Netmask** (Subnet Mask) allows you to set filtering for a whole range of IP address at once, without the need to enter all of them individually. If you are not sure about the function of

Netmask, then you should use 255.255.255.255, and it will affect only a single IP address per line of entry, or use 255.255.255.0 to use the same setting for all IP addresses starting with the same three numbers. .

After changing any of the items above, press **Apply** to save the changes. The Reset button undoes the changes that had just been made but not Applied yet.



Caution Do not accidentally block your own IP address that you are connecting from; otherwise you will not be able to access the camera any more to undo the changes. If this happens by mistake, you can do the hardware reset – it will clear all the filtering rules.

3.7.2 Port Mapping

The section **Port Mapping** provides the list of services and protocols that require their own port number for communication. By default, the camera already has all the ports defined. On this page, the user can modify the port numbers in case there is a specific need for that. Most often, the HTTP port is changed to something other than 80 in order to match with easy-to-remember port forwarding rules of the router that acts as a bridge between local area network and Internet.

Port Mapping

HTTP Port*

HTTPS Port*

Search Server Port1

Search Server Port2

Control Server Port

Streaming Server Port

RTSP Server Port

Multicast Setting

	By Requests	Multicast IP	Network Port	Multicast TTL
Stream 1	<input checked="" type="checkbox"/>	<input style="width: 100px;" type="text" value="239.198.97.181"/>	<input style="width: 50px;" type="text" value="5100"/>	<input style="width: 50px;" type="text" value="16"/>
Stream 2	<input checked="" type="checkbox"/>	<input style="width: 100px;" type="text" value="239.198.97.182"/>	<input style="width: 50px;" type="text" value="5104"/>	<input style="width: 50px;" type="text" value="16"/>
Audio	<input checked="" type="checkbox"/>	<input style="width: 100px;" type="text" value="239.198.97.183"/>	<input style="width: 50px;" type="text" value="5102"/>	<input style="width: 50px;" type="text" value="16"/>

Multicast IP [224.5.0.1 ~ 239.255.255.255]

Multicast TTL [1~255]

* New settings will only take effect after [Save & Reboot]



Note Some items appear only if the camera model supports the function.

Parameters	Description
HTTP port	Select the port assigned for HTTP protocol access.
HTTPS Port	Select the port assigned for HTTPS protocol access.
Search Server Port1	Select the first port used by server search applications to detect this IP device (e.g. IP Utility).

Parameters	Description
Search Server Port2	Select the second port used by server search applications to detect this IP device (e.g. IP Utility).
Control Server Port	Select the port used to support video control function by application programs (e.g. NVR).
Streaming Server Port	Select the port used by this IP device for Video Streaming (TCP).
RTSP Server Port	Select the port assigned for RTSP protocol access.

Multicast Setting allows users to configure the IP addresses and ports for multicast video and audio (supported models only) streams. Multicast is a protocol where a data stream is sent only once and shared to requesting devices. This in turn saves network bandwidth. However, to use this feature, network devices, such as routers and switches, should support IP multicast.

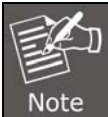
Parameters	Description
Stream 1	Refers to the video stream 1.
Stream 2	Refers to the video stream 2.
Audio	<p>Refers to the audio stream.</p> <div style="border: 1px solid black; padding: 5px;">  Appears only if the camera model supports audio input/output. </div>
By Request	When checked, the video or audio stream will be streamed only to a particular receiver when that receiver sends a request or in the case of the Network Video Recorder (NVR), select to view or record the stream. If unchecked, the video or audio stream will constantly be streamed to the network whether there are devices viewing the video or not. To save on network bandwidth, it is recommended to check this function.
Multicast IP	Set the multicast IP of the corresponding stream.
Network Port	Enter the assigned port for the corresponding stream.
Multicast TTL	Enter the multicast TTL (time-to-live) of the corresponding stream. This value determines the time span (in seconds) when the packet is retained in the network. When the time expires and no request is received, the packet is then discarded.

After changing any of the items above, press **Apply** to save the changes. The Reset button undoes the changes that had just been made but not Applied yet. New port settings will only take effect after pressing **System -> Save & Reboot**.

3.7.3 HTTPS

HTTPS protocol allows creating a secure channel over an insecure network in order to protect the data sent between the camera and its counterpart. Two things are required to have a secure communication – encrypted data, and verified counterpart of the communication. To make sure that the messages are being sent and received from true counterpart, the certificate is needed.

There are two methods to create certificates – **Certificate Signing Request (CSR)** and **Self-Signed Certificate**.

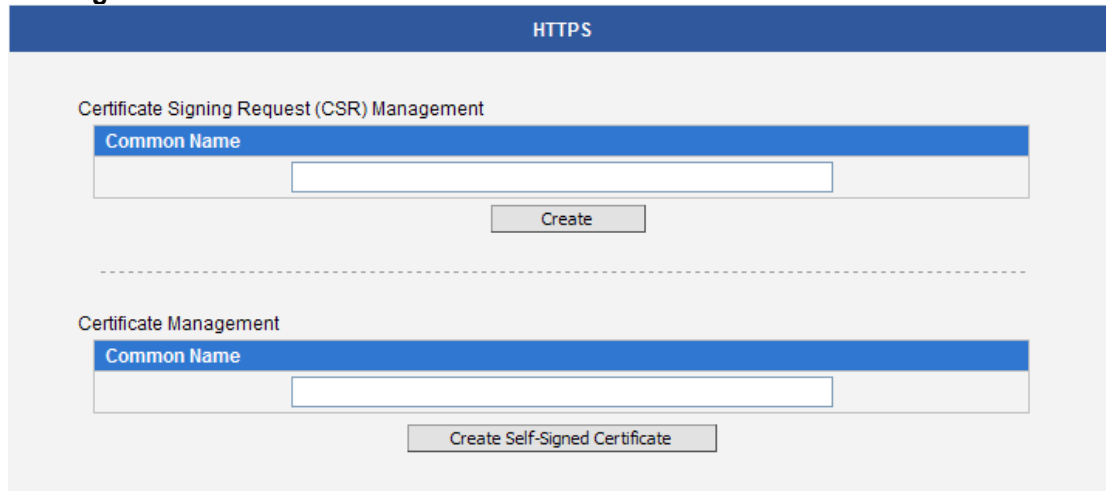

The screenshot shows a web interface for HTTPS configuration. At the top, there is a blue header with the text "HTTPS". Below the header, the page is divided into two sections. The first section is titled "Certificate Signing Request (CSR) Management" and contains a form with a blue header labeled "Common Name" and a text input field. Below the input field is a button labeled "Create". The second section is titled "Certificate Management" and also contains a form with a blue header labeled "Common Name" and a text input field. Below the input field is a button labeled "Create Self-Signed Certificate".

Certificate Signing Request (CSR): User uses a signed certificate issued by trusted Certification Authority (CA).

Self-Signed Certificate: User wants to use the certificate created and issued by user himself.

Press **Create** or **Create Self-Signed Certificate** button and configure settings in the pop-up screen to install the certificate.

Note that the new setting will only take effect after **Save & Reboot**.

3.7.4 IEEE 802.1X

IEEE 802.1X is an IEEE standard for port-based Network Access Control. 802.1X authentication involves three parties: a supplicant, an authenticator, and an authentication server.

The supplicant is a client device (such as an IP camera) that wishes to attach to the LAN/WLAN. The authenticator is a network device, such as an Ethernet switch or wireless access point; and the authentication server is typically a host running software supporting the RADIUS and EAP protocols.

The authenticator acts like a security guard to a protected network. The supplicant (i.e., client device) is not allowed access through the authenticator to the protected side of the network until the supplicant's identity has been validated and authorized. An analogy to this is providing a valid passport at an airport before being allowed to pass through security to the terminal. With 802.1X port-based authentication, the supplicant provides credentials, such as user name/password or digital certificate, to the authenticator, and the authenticator forwards the credentials to the authentication server for verification. If the authentication server determines the credentials are valid, the supplicant (client device) is allowed to access resources located on the protected side of the network.

Please **enable** IEEE 802.1X and configure settings on the screen below. Note that the new setting will only take effect after “Save & Reboot”.

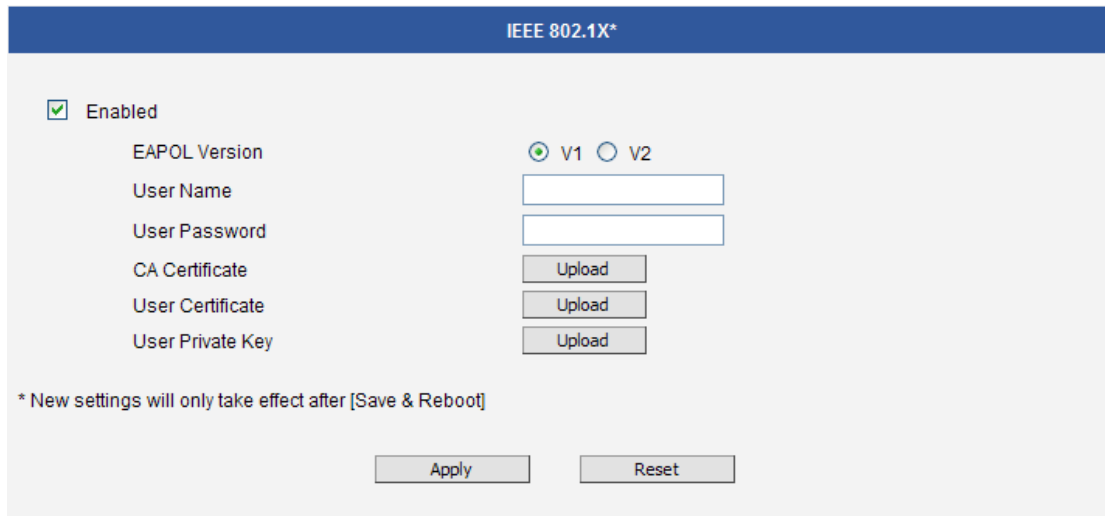

EAPOL Version 1 and 2 are the 802.1X communication types. **User name** and **User password** area created by user and set in RADIUS server. **Certificates** and **Private Key** are provided by RADIUS Server.

If certificates or private key exist already, there will be a **Remove** button behind these items, in order to remove these items when necessary.

After changing any of the items above, press **Apply** to save the changes. The **Reset** button undoes the changes that had just been made but not Applied yet.

3.7.5 SNMP Setting

The SNMP Setting item displays the SNMP configuration page.

SNMP provides an easy way to manage network devices. The main features are:

1. Monitoring device uptime
2. System detail description. (e.g., model name, model description and firmware version.)
3. Collect interface information. (e.g., MAC address, interface speed and local port.)
4. Measuring network interface throughput.

To use SNMP, just **enable** SNMP function in the camera (SNMP agents) and run SNMP management software in server (NMS: Network Management Station) to connect to the devices.

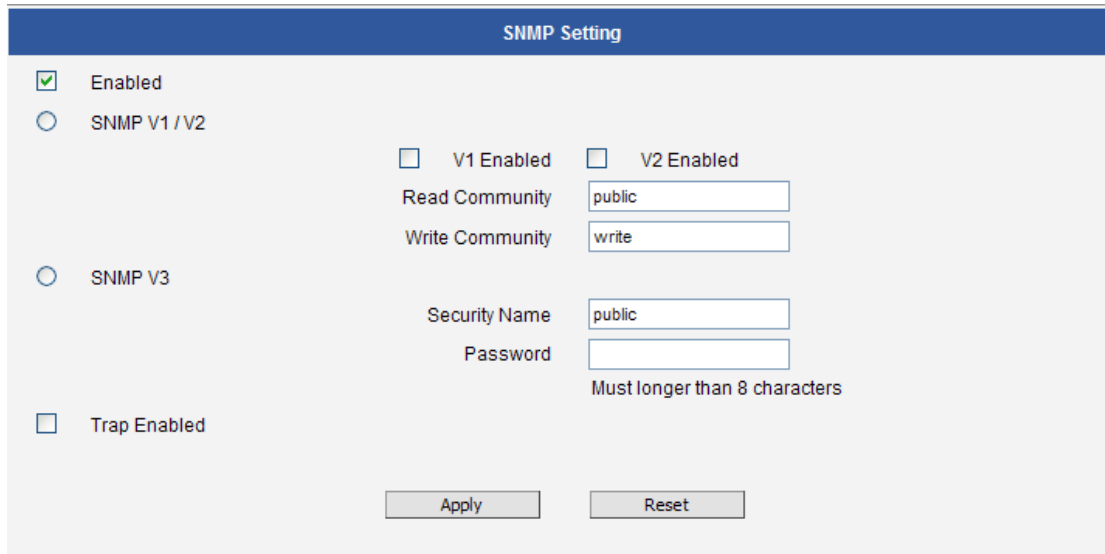

The image shows the 'SNMP Setting' configuration page. At the top, there is a blue header with the text 'SNMP Setting'. Below the header, there are several options:

- Enabled
- SNMP V1 / V2
 - V1 Enabled
 - V2 Enabled
 - Read Community:
 - Write Community:
- SNMP V3
 - Security Name:
 - Password:
 - Must longer than 8 characters
- Trap Enabled

 At the bottom of the page, there are two buttons: 'Apply' and 'Reset'.

The SNMP agent supports versions 1, 2 and 3. SNMP v1 is the initial implementation of SNMP. SNMP v2 is proposed to enhance the performance of management, such as the communication of server and devices, the confirmation of information delivery and receipt. Primary additions in SNMP v3 concern security and remote configuration enhancements.

SNMP v1/v2 uses “Community” name as password to authenticate identity. “Read Community” is the password for server to get information from devices. “Write Community” is the password for server to edit values on devices. The default is “public” for Read Community and “write” for Write Community. Of course, you can set any other password as your read/write community.

You can enable v1, v2 or both. Click “**Apply**” after you’ve completed the setup.

The security method of **SNMP v3** uses account/password for authentication. “Security Name” is the account name to be used with your “Password”. The default security name is “public” and the password must be at least 8 characters long. You also can set any other security name or password. Click “**Apply**” after you’ve completed the setup.

SNMP function is now enabled. You may now install and run the SNMP management software on computer server.

SNMP Trap Usage:

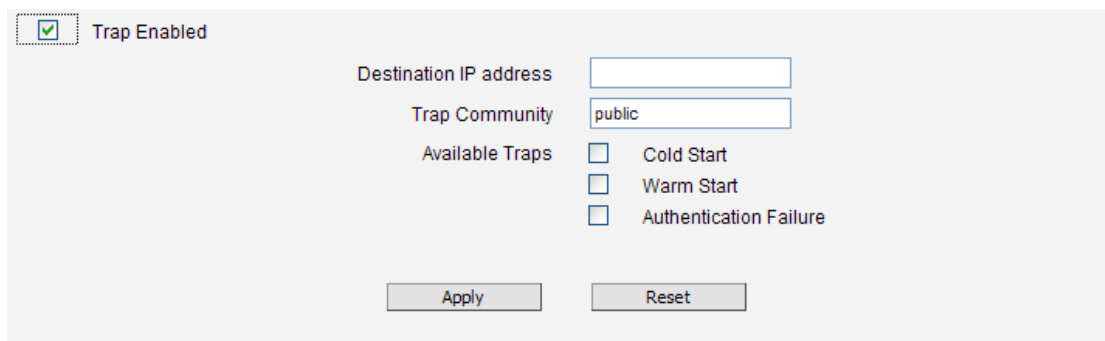

The image shows the 'SNMP Trap Usage' configuration page. At the top, there is a checkbox labeled 'Trap Enabled' which is checked. Below this, there are several fields:

- Destination IP address:
- Trap Community:
- Available Traps:
 - Cold Start
 - Warm Start
 - Authentication Failure

 At the bottom of the page, there are two buttons: 'Apply' and 'Reset'.

SNMP traps enable notifications from devices. Devices may send message to the management server whenever significant events occur such as cold start, warm start and

authentication failure. The manager will get the information immediately and take action if necessary.

Cold start means device reboot by power disconnection. **Warm start** means device reboot by firmware without power disconnection. If there other parties attempt to connect to the device with wrong security password under SNMP v1, v2 or v3 setting, the device will send an **authentication failure** message to the management server.

To enable SNMP Trap function in the camera, type the IP address of the computer running the SNMP management software and type trap community as password to allow server to get trap message from device (Default is public). Select available traps and click **Apply**.

Camera's SNMP offers the following information:

Group	Description
System	Provides general information about the managed device. <i>For example, system description and system name.</i>
Interface	Provides general information from the physical interfaces. <i>For example, interface speed and MAC address.</i>
Address Translation	Provides information about the mapping between network addresses and physical addresses for each physical interface. <i>For example, the IP/MAC addresses are to connect to the managed device.</i>
IP	Provides the status and operation of Network Layer (Layer 3). <i>For example, the information and traffic flow of received/delivered package.</i>
ICMP	Provides the status and statistics of ICMP. <i>For example, amount of receive/error message of ICMP.</i>
TCP	Provides the status and operation of Transport Layer (Layer 4) using TCP protocol. <i>For example, TCP Local Port and incoming/outgoing TCP segments.</i>
UDP	Provides the status and operation of Transport Layer (Layer 4) using UDP protocol. <i>For example, UDP Local Port and in/out datagram.</i>
SNMP	Provides the related statistics through SNMP

3.7.6 RTP

The **RTP** section allows user to configure RTP Settings.

If the **RTSP Authentication** is **Enabled**, then the RTP streaming will require account name and password authentication.

If the **RTP B2 Frame** is **Enabled** then the B2 frame is added to every video frame, containing additional information, such as **motion detection status on each frame, digital input and digital output levels, passive infrared status, other video intelligence data, frame counter, frame-rate mode and the frame-rate, bitrate, resolution, timestamp and much more**. The user side can operate with video data easily, including event management, storage consumption estimation, image resizing for preview, etc.

RTP

RTSP Authentication

RTP B2 Frame

After changing any of the items above, press **Apply** to save the changes. The **Reset** button undoes the changes that had just been made but not Applied yet.

3.7.7 Network

The Network section contains the controls for the following functions:

- Type of Service
- UPnP
- Bonjour
- ONVIF

Type of Service

The “Type of Service” provides 4 options to define the priorities of how the data from the camera should be handled by the routers that support ToS concept. By default, the ToS priority is set as “Normal Service”.

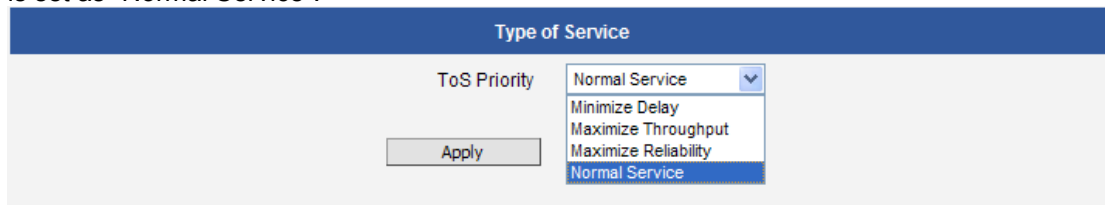

For special priority arrangement, there are 3 more options:

- Minimize Delay
- Maximize Throughput
- Maximize Reliability

After changing any of the items above, press **Apply** to save the changes. The Reset button undoes the changes that had just been made but not Applied yet.

UPnP™

The **UPnP™** section provides the option to enable or disable the Universal Plug and Play capability of the camera. Having the UPnP™ enabled allows the other network devices to seamlessly discover it on the network for convenient identification and access.

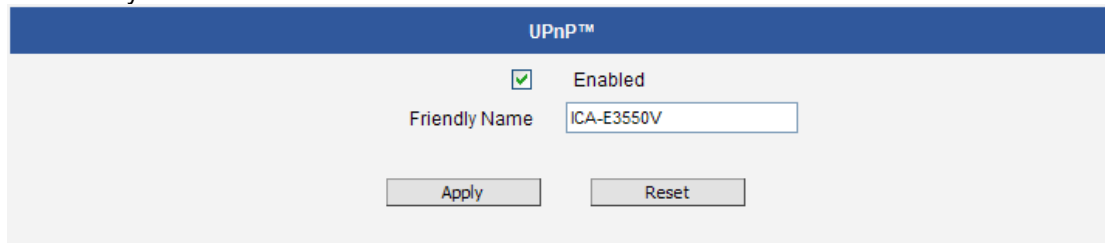

The **Friendly Name** is a human-readable name for the device that will be displayed when the camera is found. By default, the serial number of the camera is used as a friendly name; however, the user can modify the name according to the project needs.

After changing any of the items above, press **Apply** to save the changes. The Reset button undoes the changes that had just been made but not Applied yet.

Most of the Windows-based computers have the capability to discover the devices that support UPnP™. Below is the example of Windows 7: By clicking on the **Network** icon of **Windows 7**, the PC will discover the cameras instantly.

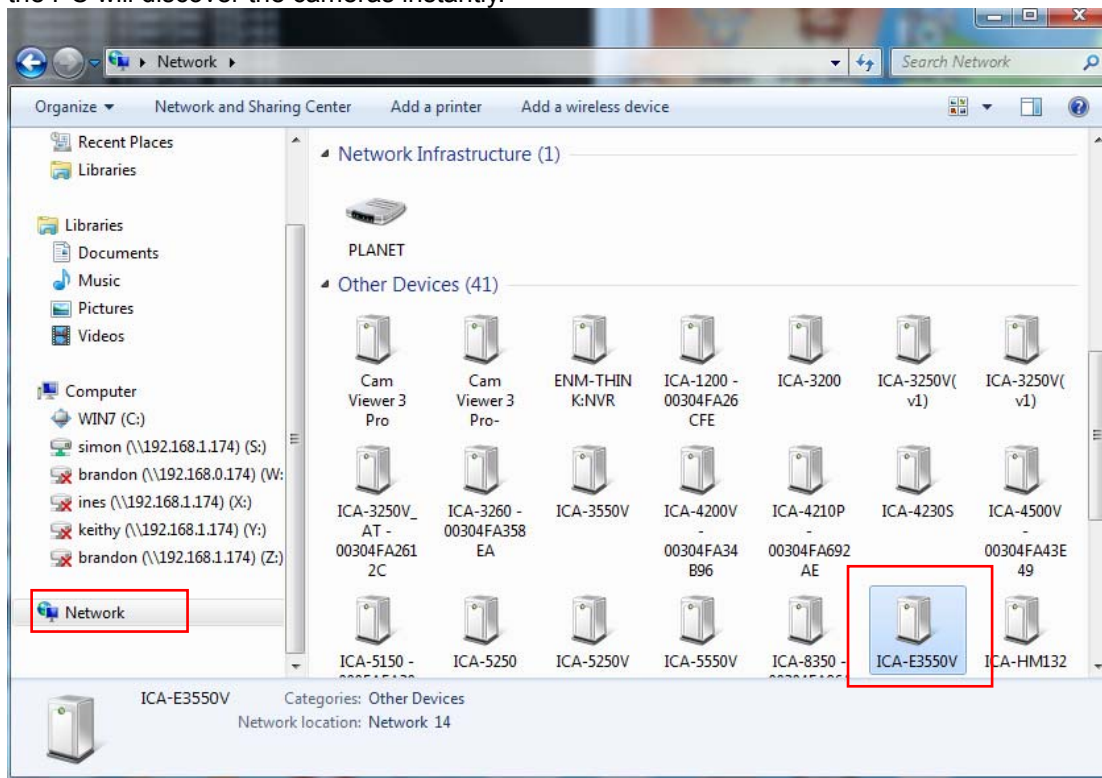

Bonjour

The **Bonjour** section provides the option to enable or disable the ability of the camera to be discovered by the other network devices using Bonjour protocol, developed by Apple Inc. Both Bonjour and UPnP serve the similar purpose – to discover devices conveniently.

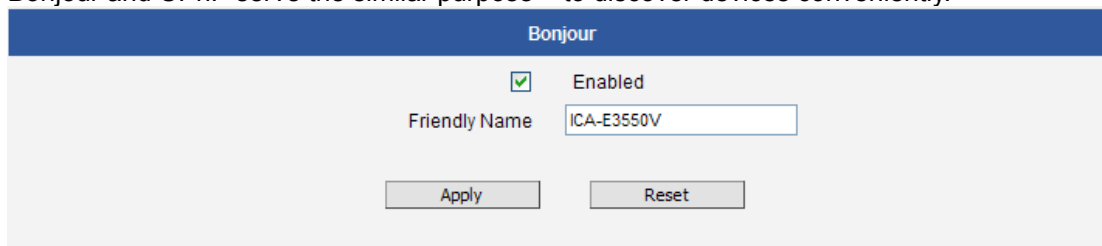

Similarly to UPnP, the human readable **Friendly Name** can be defined by the user. That name will be displayed when the camera is found in the network. By default, the Friendly Name is the serial number of the camera; however, the user can modify the name according to the project needs.

After changing any of the items above, press **Apply** to save the changes. The Reset button undoes the changes that had just been made but not Applied yet.

ONVIF

The camera with given firmware is ONVIF 2.2 compliant. By default, the ONVIF function is enabled.

To disable the ONVIF support, remove the check mark from the check box and press **Apply**.

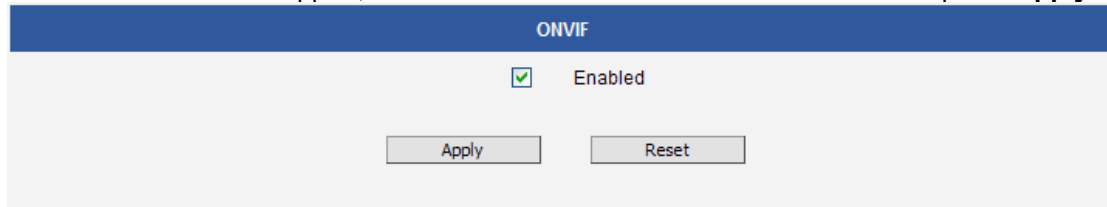

If you need to activate ONVIF on multiple cameras conveniently, you may use the IP Utility instead, using **system** cgi and **ONVIF_STATE=1** as URL command.

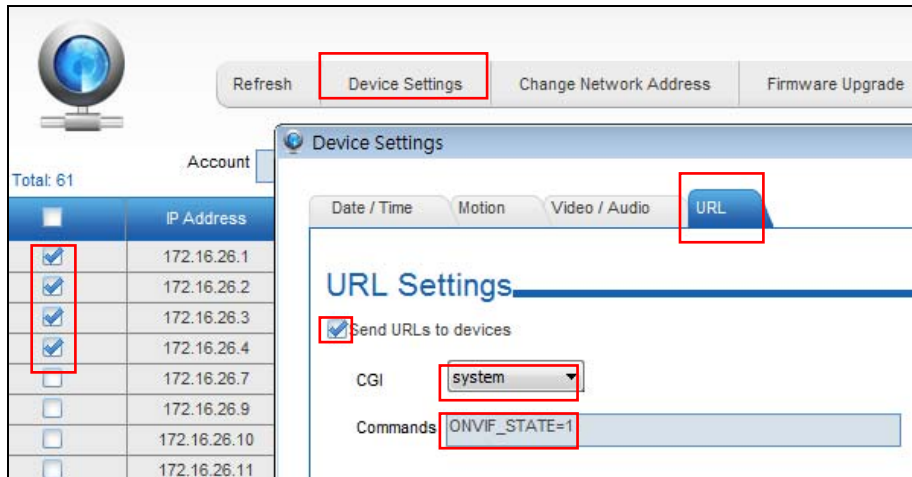

3.8 IP Settings

The **IP Settings** section provides the options to define how the camera would obtain its IP address; and to which DNS server should the camera connect, in order to resolve domain names.

3.8.1 Connection Type

The **Connection Type** allows defining the method of obtaining the IP address of the camera. By default, the camera is in **Dynamic IP Address** mode and attempts to get the IP address from a DHCP server. If such attempt fails after several seconds (for example the DHCP server does not exist), the camera will automatically assign itself an IP address, listed under the Static IP Address.

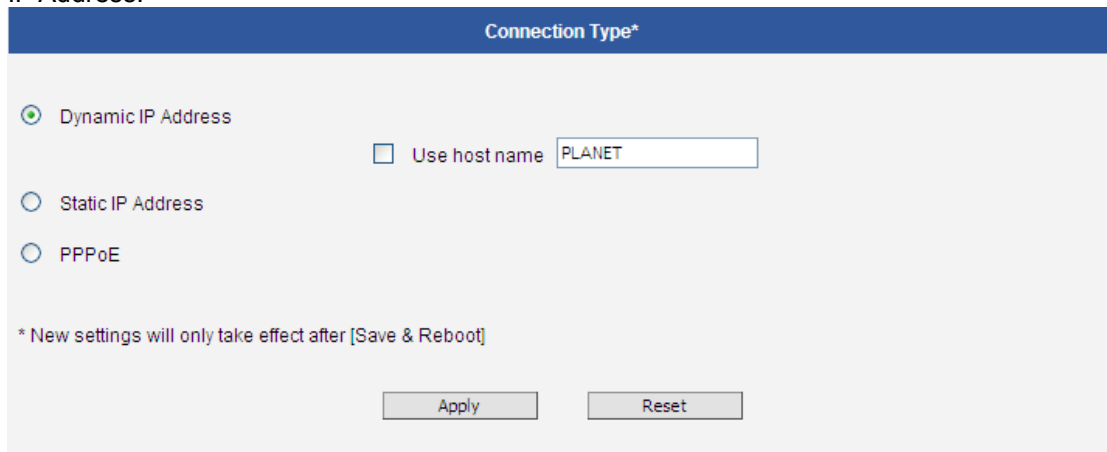

Host Name is used to identify the camera by a DHCP server. In some networks with very strict security policy, it is required that all the network devices should have their host name, and when the devices attempt to access the network by requesting an IP address from a DHCP

server, the DHCP server would check if the host name is among the allowed devices. On this page, it is possible to edit the Host Name and enable or disable the use of host name.

Connection Type*

Dynamic IP Address
 Static IP Address

IP Address
 Subnet Mask
 Gateway

PPPoE

* New settings will only take effect after [Save & Reboot]

Most installation projects include clear network topology and static IP addresses for each camera. In such cases, you can change the camera to **Static IP Address** mode and modify the **IP Address**, **Subnet Mask** and **Gateway** accordingly.

Connection Type*

Dynamic IP Address
 Static IP Address
 PPPoE

User Name
 Password

* New settings will only take effect after [Save & Reboot]

In some rare cases, the camera may be connected to the control center over Internet. Usually, the most cost efficient way is to use ADSL connection with **PPPoE**. To avoid the unexpected changes of IP addresses by Internet Service Provider upon the restart of the camera, it is recommended to activate a DDNS service for such scenario, and let the control center connect to the camera by the domain name instead. Please refer to the DDNS section for more details.

To set the camera in PPPoE mode, set the radio button to PPPoE and key-in the User Name and Password, provided by Internet Service Provider.

After changing any of the items above, press **Apply** to save the changes. The Reset button undoes the changes that had just been made but not Applied yet.

New IP address settings will only take effect after pressing **System -> Save & Reboot**.

3.8.2 DNS

The **DNS** section allows setting up the Domain Name Service for the camera. The camera will connect to the DNS server when there is a need to resolve a domain name for sending data to.

The most common usage is the FTP or e-mail server in the Event Handler section, which is defined by using domain names. Without having DNS service configured, the camera would not know how to resolve the domain names of FTP or e-mail servers.

It is possible to configure both **Primary** and **Secondary DNS servers**. The Secondary DNS Server will be used when the connection to the Primary DNS Server fails.

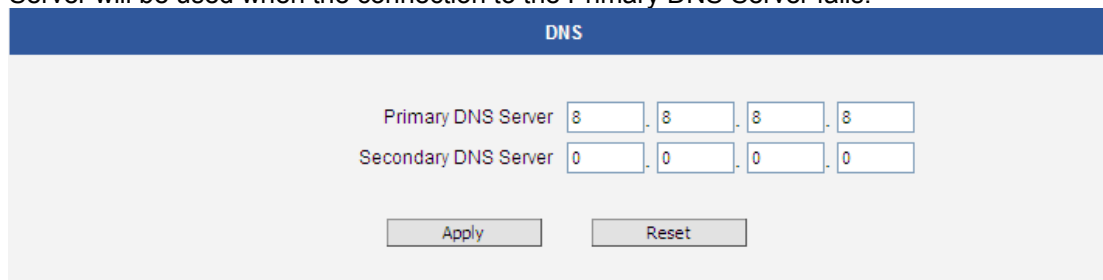

After changing any of the items above, press **Apply** to save the changes. The **Reset** button undoes the changes that had just been made but not Applied yet.

3.8.3 DDNS & P2P

There are surveillance solutions that consist of single cameras scattered over a wide territory, therefore each of those cameras should be connected to Internet in order to become accessible by Control Centers, such as chain stores, bus stops, currency exchange booths, etc.

In such cases, one of the practical networking solutions is to use DSL modem on camera site and let the camera obtain the dynamic IP address from the Internet Service Provider through the DSL modem using PPPoE connection, which is much more cost-effective than applying for static IP address.

However, there is one drawback in this solution – in order to do the remote surveillance from the Control Center, the NVR Server in the Control Center has to know the address of the IP camera at all times in order to get the video stream from the camera. If the camera's network connection has been reset for any reason, the camera will get a new IP address through DSL modem, which may be different from the previous one. NVR will not know about this change, and the connection between the camera and NVR will fail.

There however exists a solution that makes sure the NVR can find the camera even if the camera IP changes frequently. Our cameras support **Dynamic DNS** or **DDNS** service that allows frequently changing IP be mapped to a certain unchangeable domain name. The mapping database and its updating engine are hosted in one of the Dynamic DNS servers, most of which offer basic services for free, such as www.dyndns.org.

Every time the IP camera gets an IP that is different from previous one, it notifies the public DDNS Service about the change. The DDNS Service updates its database immediately, mapping the assigned domain name (for example *camera123.dyndns.org*) to the new IP address. In NVR settings, only the domain name (*camera123.dyndns.org*) is used to identify the camera. Every time when NVR needs to connect to the camera, it asks from DDNS Service what the current camera's IP is. The DDNS Service instantly responds to NVR and tells it the camera's IP. Now NVR will use the IP of the camera to connect to the camera and the video stream from the camera to NVR can be initiated.

As a result, NVR can always find the IP camera regardless of frequently changing IP address of the camera. Since there are so many public DDNS Services available for free, the PPPoE-based connection is really a good and low-cost solution for single-camera sites.

DDNS

Enabled

As a service / As a protocol reference

Host Name

User Name

Password

To activate DDNS, please check the “**Enabled**”. Select the service reference, input the **Host Name** (the domain name given to the camera by DDNS service, **User Name** and **Password** of the DDNS server account.

You will get the needed Host Name, User Name and Password information from the DDNS service provider once you have registered an account there and requested a domain name for your camera.

After changing any of the items above, press **Apply** to save the changes. The Reset button undoes the changes that had just been made but not Applied yet.

P2P function is reserved for future usage. This function is not available now.

P2P

Enabled

P2P Protal Address

P2P Protal Port

User Name

Password

UUID Status

3.9 Video & Audio

The **Video** or **Video & Audio** section (for audio supported cameras) provides the options to adjust the video quality, configure the streaming details of the camera, and audio settings (for Audio supported cameras only), which will be described on the succeeding pages.

The default settings of the camera are sufficient for most environments and the video adjustments are not necessary. The following sections explain the ways to configure the video quality or streaming details in case it is required to do so.

The **[+]** mark before Video indicates that the list can be expanded by clicking on it. Once expanded, the list can later be collapsed again by clicking on the **[-]** mark.

3.9.1 Camera Options

In general, the **Camera Options** allows users to set line frequency of the camera.

Line Frequency is the function that adjusts the shutter speed options to match with the frequency of artificial light source of given country. For example, in Europe the light frequency (due to power supply frequency of lights) is 50Hz, that is 50 flashes per second. By setting line frequency to 50Hz in such case, the shutter speed options will be proportional with light source frequency, such as 1/25s, 1/50s, 1/100s, etc.

It is necessary to have the camera's Line Frequency adjusted according to the power frequency of the light source to avoid flickering effect.

The natural light source (sun light) is a seamless flow of light – the Line Frequency setting does not matter for the cameras that are only exposed to natural light.

3.9.2 Video

The sub-section is also named **Video**. For Audio supported cameras, there will also be a sub-section named Audio. The video section is divided into tabs. The functionality of each tab is explained separately below.

Upon opening the sub-section named Video, the live view of the Stream 1 of the camera will appear. Since the camera is a dual stream device, it is possible to see how each of the 2 streaming configurations looks like, by selecting either **Stream-1** or **Stream-2** under the live video window.



Usually, Stream-1 is configured to be high quality video with maximum resolution and frame rate for recording purposes while Stream-2 is usually a moderate quality stream for live view purposes of the VMS, to reduce VMS computing power during video decoding of multiple channels.

Compression

The “Compression” section allows the user to define the compression settings of the video stream 1 and stream 2. The purpose of compression is to reduce the bandwidth and VMS storage consumption.

Usually stream 1 is configured to be the best quality stream for NVR recording purposes while the stream 2 is configured to be with the basic quality for the live view of NVR, to minimize the

computing power of NVR used for video decoding.

Stream 1	Stream 2
Encoder Type: H.264	Encoder Type: H.264
H.264 Profile: Main Profile	H.264 Profile: High Profile
VGA Aspect Ratio: 4:3	VGA Aspect Ratio: 4:3
Resolution: N2592x1944	Resolution: N640x480
Frame Rate: 15	Frame Rate: 15
Video Bit Rate Mode: Variable Bit Rate	Video Bit Rate Mode: Variable Bit Rate
Quality: High	Quality: Medium
GOP 1 I-frame / 1 Second	GOP 1 I-frame / 1 Second
<input type="button" value="Apply"/> <input type="button" value="Reset"/>	

Parameters	Description
Encoder Type	There are two encoder types available: H.264 (High Profile) and MJPEG.
H.264 Profile	<p>This item is available only if the Encoder Type is H.264. The H.264 Profile defines the video compression scheme: High Profile, Main Profile, and Baseline. These schemes vary from least compressed, Baseline, to most compressed, High Profile. By default, the H.264 Profile is High Profile, which provides the most compression with the best video quality, but more computing power.</p> <p>Some third-party video management system has longer latency or takes more time to decode High Profile compression scheme, in this case, you can select Main Profile or Baseline. In order to get the same video quality, you can select a higher bit rate with lower compression; this is the same as having a lower bit rate with a High Profile. For example, a video on High Profile with 2M bit rate will have the same video quality as a video with Baseline Profile at 3.5M bit rate.</p>
VGA Aspect Ratio	It is used to define the aspect ratio of VGA stream – it can be either 4:3 ratio (640x480) or 16:9 ratio (640x360). When “Auto Detected” is chosen, the VGA stream will follow the ratio of the higher resolution stream, to ensure the identical view of stream 1 and stream 2.
Resolution	Depending on the camera model, the number of available resolutions may be different. The default resolution setting of the camera may not necessarily be the maximum resolution of the camera. If the user wants to use the maximum resolution, it is possible to do it here. The maximum possible resolution of stream 2 will be smaller than stream 1.
Frame Rate	Defines the amount of frames per second.
Video Bit Rate Mode (only for H.264)	<p>Under “Constant Bit Rate” mode (CBR), the camera keeps the stable bitrate regardless of the complexity of the scene. Under this mode, the video quality may vary if the bit rate value is set too low. It is easier to do storage and network bandwidth consumption estimations under this mode compared to Variable Bit Rate mode.</p> <p>Under “Variable Bit Rate” mode (VBR), the camera will keep the video quality stable while the bit rate may occasionally go up or down, depending on the complexity of the scene.</p>
Video Max Bit Rate	Defines the upper limit of the bitrate (only available under CBR mode).

Parameters	Description
(only for H.264)	<p>The bitrate will be floating slightly under that limit. For example, if the limit is set as 2M, the bitrate will be floating around 1.6~2.0Mbps.</p> <div style="border: 1px solid #ccc; padding: 5px; width: fit-content; margin: 10px auto;"> <p>Video Bit Rate Mode Constant Bit Rate ▾</p> <p>Video Max Bit Rate Unlimited ▾</p> <p>Video Bit Rate 2M ▾</p> </div> <p>If the Video Max Bit Rate is chosen as “Unlimited”, then the “Video Bit Rate” selection box will appear that defines the bit rate level.</p>
Video Bit Rate (only for H.264)	<p>Under CBR mode, when Video Max Bit Rate is chosen “Unlimited”, the user can define the AVERAGE bit rate. For example, if the Video Bit Rate is chosen 2M, then occasionally, the actual bit rate may go below or beyond 2M, but in the long run, the average bit rate will be very close to 2M. This mode allows the most accurate storage estimations, however, while planning the bandwidth, please consider the occasional peaks of bit rate.</p>
Quality	<p>H.264 Compression:</p> <div style="border: 1px solid #ccc; padding: 5px; width: fit-content; margin: 10px auto;"> <p>Video Bit Rate Mode Variable Bit Rate ▾</p> <p>Quality Medium ▾</p> <p>GOP 1 I-frame / 1 Second ▾</p> </div> <p>Under VBR mode, the bit rate will be floating while the video quality will be stable and follows the quality standard set by the user. The user can choose either “High”, “Medium” or “Low” quality. The higher is the quality level, the more bit rate the camera will use to achieve the target quality.</p> <p>MJPEG Compression: The user can define the quality with the numeric scale from 1 to 100. The default MJPEG quality is 60. The higher is the quality level, the more bit rate the camera will use to achieve the target quality.</p>
GOP (only for H.264)	<p>Under VBR mode it is possible to adjust the GOP length - that is the occurrence rate of I-frames. By default, there is one I-frame per second. For example, in case of 30fps, there will be 1 I-frame and 29 P-frames every second by default. When the GOP is changed to “1 I-frame per 5 seconds”, then there will be one I-frame, followed by 149 P-frames. In case of the static scenes, long GOP can further minimize the bandwidth and storage consumption.</p>

After changing any of the items above, press **Apply** to save the changes. The Reset button undoes the changes that had just been made but not Applied yet.

Motion Detection

The “Motion Detection” section allows the user to configure the video motion detection system of the camera. Motion detection regions are based on Stream 1. By default, there are three (3) enabled pre-defined regions covering the whole camera view.

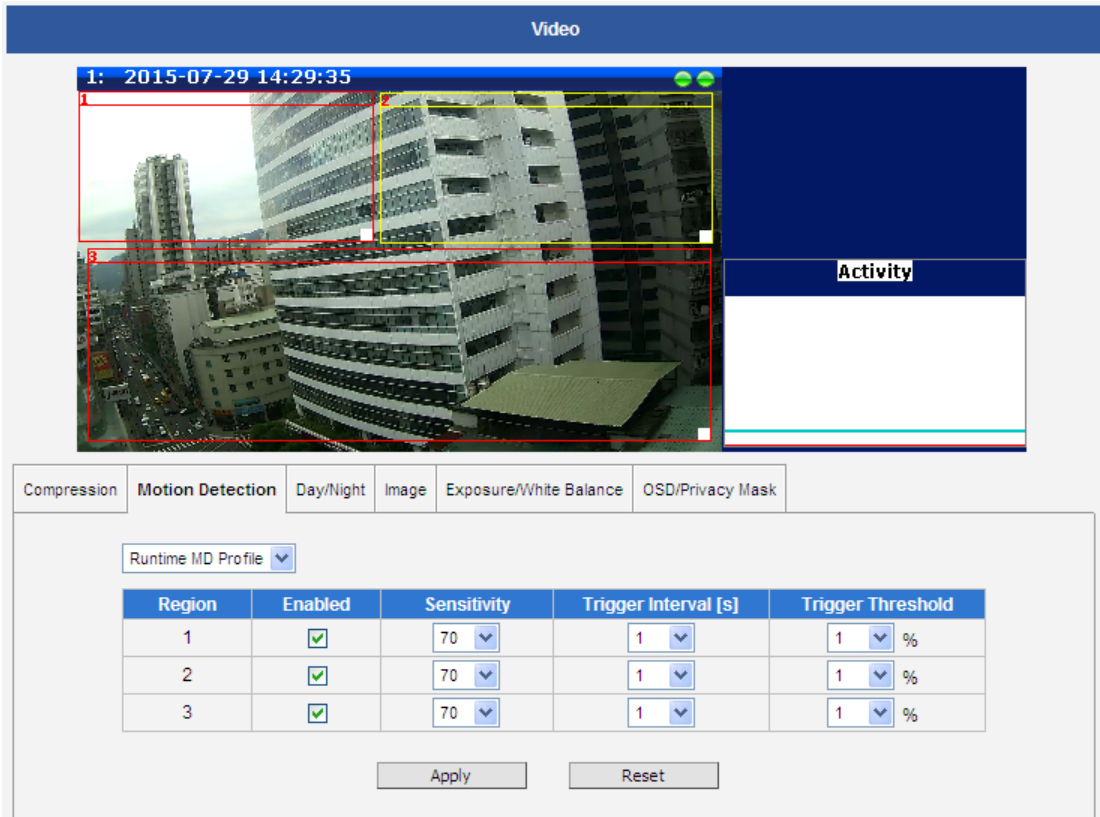

Region	Enabled	Sensitivity	Trigger Interval [s]	Trigger Threshold
1	<input checked="" type="checkbox"/>	70	1	1 %
2	<input checked="" type="checkbox"/>	70	1	1 %
3	<input checked="" type="checkbox"/>	70	1	1 %

Click on “Setup” to adjust the motion detection regions or its parameters. **Microsoft Internet Explorer** browser is required to configure the motion detection regions.

There are three independently configurable motion detection regions in the camera.

Each motion detection region has 6 configuration parameters:

- Enabled or disabled
- Location of the region
- Size of the region
- Sensitivity
- Trigger threshold
- Trigger interval

Enabled or disabled

Although all 3 motion detection regions are enabled by default, each can be disabled and enabled individually. Look at the example: Only region 1 is enabled while 2 and 3 are disabled. The disabled regions disappear from the video display.

Note that the number of the motion detection region is written in the upper left corner of the region.

Runtime MD Profile		
Region	Enabled	Sensitivity
1	<input checked="" type="checkbox"/>	70
2	<input type="checkbox"/>	70
3	<input type="checkbox"/>	70

Location of the region

You can move the motion detection region anywhere on the field of view by dragging the top of the motion detection rectangle as shown on the image. The motion detection regions may even be overlapping if you like.



Size of the region

By dragging the lower right corner of the motion detection region you can change the size of the region. The maximum size of the region can even be as big as the whole screen.



Sensitivity

Sensitivity is the parameter that helps us distinguish actual moving targets (people, vehicles) from the slightly moving background, such as leaves of the trees waving in the wind. In order to avoid false alarms, we might want the camera be able to ignore small motion. The higher is the sensitivity level of the camera the smaller shift of the object is needed to trigger the alarm. For example, if the object within motion detection region has moved for about 1-3 pixels during two video frames, then such small motion will be discarded by camera if the sensitivity is low, and will still trigger an alarm if the sensitivity is high. In other words, you can think of sensitivity level as a **reversed speed limit** – the smaller is the sensitivity, the faster are the objects allowed to move without being detected.

The biggest challenge of motion detection configuration is to find the settings that do not produce false alarms and at the same time do not miss any actual intrusions. The rule of thumb is: **the sensitivity should be as high as possible while not producing false alarms**. The default sensitivity level of the cameras is 70 (on a scale of 0-100) and it is a good setting for most standard cases.

Trigger threshold

Look at the moving object entering the area of motion detection: although moving quite slowly, it caused motion activity – several pixel regions reported a motion that was faster than allowed

“speed limit” of sensitivity (70).



Runtime MD Profile				
Region	Enabled	Sensitivity	Trigger Interval [s]	Trigger Threshold
1	<input checked="" type="checkbox"/>	70	1	10 %
2	<input type="checkbox"/>	70	1	10 %
3	<input type="checkbox"/>	70	1	10 %

The blue graph on the right side of the image shows how many percent of pixels within the motion detection region were considered as “currently in motion”. The activity panel itself is a timeline – for each moment of time you can see the height of the blue bars. You may notice that at certain moment the tallest bars in the activity graph reached about 25% (a quarter of the total height in activity panel) – it means, 25% of this motion detection area were filled with moving pixels at that moment. By visual observation you can also see that the object standing inside the motion detection region indeed covers about 25% of its size.









What if the object is really small but moves rather fast (gets triggered by the current sensitivity level)? For example, we want to detect people but not the cat walking in the room. Although both people and cat may move with the speed that will trigger motion, they have different size of triggered pixels. For example, a human passing by the motion detection region will trigger 25% of pixels in that region while the cat would trigger only 2%. Since we want to have a real alarm in case of human or vehicle passing by while ignoring birds, cats, butterflies, mice, etc, we need a filter that can define how many percent of triggered pixels will be considered as a real alarm. This parameter is called **trigger threshold**. The default value of trigger threshold is 10%. It means, only the objects that are bigger than 10% of the motion detection region size and move faster than allowed by sensitivity level (70) will produce actual alarm.

How to choose the most optimal trigger threshold level? The rule of thumb, **keep the trigger threshold as small as possible while not causing false alarms by the moving objects that are not humans or vehicles.**

You can have different sensitivity level and trigger threshold level for each motion detection region.

In order to understand all of the above even better, please refer to the table below containing four possible combinations of settings using sensitivity level and trigger threshold percentage.

The objects listed in each cell will trigger an alarm under given settings:

	Low threshold (0-5%)	High threshold (5-100%)
Low sensitivity (0-65)	Big and fast  Small and fast 	Big and fast 
High sensitivity (65-100)	Big and fast  Big and slow  Small and fast  Small and slow 	Big and fast  Big and slow 

The camera's default sensitivity is 70 and threshold is 10%. By these default values, only the rabbit and the turtle would trigger an alarm while the butterfly and the snail would be ignored by the motion detection system.

Important: Please remember that changing the size of the motion detection region has an impact on the threshold – the bigger is the size of the motion detection region the smaller should be the threshold value if you want the same object size to trigger motion. For example, if you increase the motion detection region to twice the previous size, please remember to reduce the threshold to half its original value (from 10% to 5%). On the other hand, changing the location of the motion detection region has no impact on threshold.

Trigger interval

The last configuration item is the trigger interval. It is the time period from the beginning of the triggered event during which the all motion activities are ignored by the camera. This is designed to avoid needless repetitive reporting of the same intrusion. Trigger interval 20 seconds would mean that when the even happens, camera will take certain one-time actions and ignore the continuing activity in the motion detection region for 20 seconds. When 20 seconds are over, the camera will produce a new alarm if there are still action in the motion detection region, and take actions again.

There is one more item on the Motion Detection configuration page which was not explained above – the **Profile of Motion Detection**. Think of them as **Profile 1** (Runtime MD Profile) and **Profile 2** (Event MD Profile). It means that you can configure two independent groups of Motion Detection regions with at most 3 regions in each group. Normally, the Profile 1 (Runtime MD Profile) is used as an active profile of the camera. However, in some cases it is possible to let the camera switch to Profile 2 by using the Event Handler system of the camera.

Runtime MD Profile		Enabled	Sensitivity
1	<input checked="" type="checkbox"/>	70	
2	<input type="checkbox"/>	70	
3	<input type="checkbox"/>	70	

For example, you might want to have different motion detection parameters for day and night

time. Then the two profiles become really handy. In such case, remember to configure the motion detection parameters for both profiles before moving on to configure the event response system.

After changing any of the items above, press **Apply** to save the changes. The Reset button undoes the changes that had just been made but not Applied yet.

Day/Night

The **Day/Night** section allows user to control the switching between day mode and night mode. This section will be displayed only for day/night models.

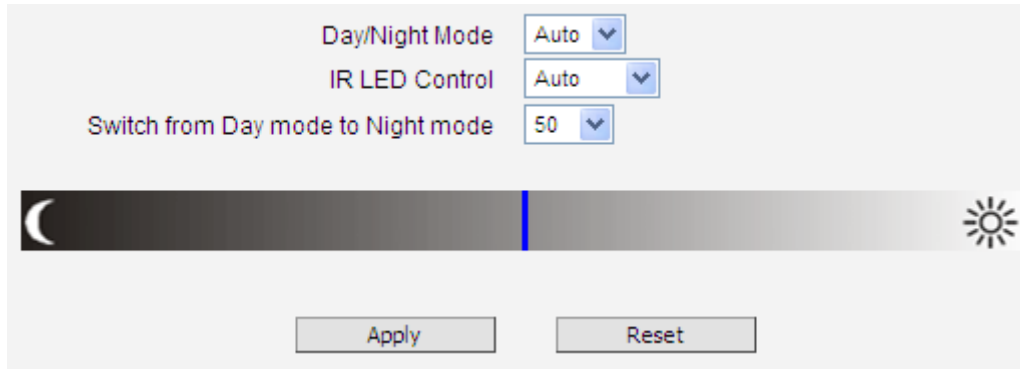

Parameters	Description
Day/Night mode	<p>There are three modes:</p> <p>Auto: The camera will automatically switch between day mode (color) and night mode (black/white) under certain exposure level, defined by user at “Switch from Day mode to Night mode”.</p> <p>Day: The camera always stays in day mode (color) regardless of exposure level.</p> <p>Night: The camera always stays in night mode (black/white) regardless of exposure level.</p>
IR LED Control	<p>This feature is visible only in cameras with built-in IR LED.</p> <p>There are two modes:</p> <p>Auto: The built-in IR LED will be turned on automatically upon day to night switch and turned off upon night to day switch.</p> <p>Disabled: The IR LED will be off regardless of day and night mode.</p> <p>Zoom cameras have adaptive IR profile, which means that when IR LED Control is set to “Auto” (default setting), the IR LED automatically adapts to the required IR LED power as the camera is zoomed in or out.</p>
Switch from Day mode to Night mode	<p>The scale of 0~100 allows user define the exposure level at which the day to night switch should happen. The higher is the value, the darker the environment has to be to trigger the day to night switch.</p>

Image

The **Image** section allows user to control certain parameters of a video frame.

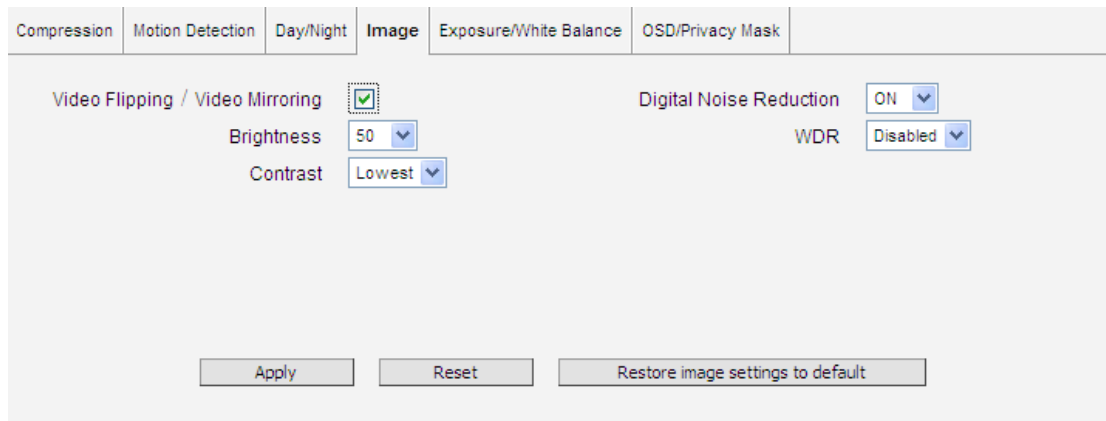

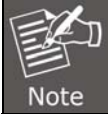
Parameters	Description
Video Flipping/Video Mirroring	Check this box to flip the video up-side-down and left-right to achieve the 180-degree rotation effect.
Brightness	Select the Brightness value (0~100). The higher the value, the brighter the image.
Contrast	Select the Contrast level from following options: Lowest, low, medium, high, highest
Digital Noise Reduction	Turn ON or OFF the Digital Noise Reduction. When turned on, the noise on the video (especially in low light) is reduced and image will look smoother and clearer.
WDR	Choose the WDR level from following options: Disabled, low, medium, high, highest. <div style="border: 1px solid black; padding: 5px; margin-top: 5px;">  Note WDR is disabled and will not appear on screen if Exposure Mode is set to "Manual". </div>

After changing any of the items above, press **Apply** to save the changes. The Reset button undoes the changes that had just been made but not Applied yet.

The button "**Restore image settings to default**" is a quick way of restoring factory default image settings without needing to reset the whole camera to factory default.

Exposure/White Balance

The **Exposure / White Balance** section allows the user to configure Exposure (shutter, iris and gain control) and White Balance settings. In most cases, the default settings are sufficient and no adjustment is needed. Some options will only appear under certain Exposure/White balance modes. Each mode is described in detail below.

IR Exposure Compensation - Enabled

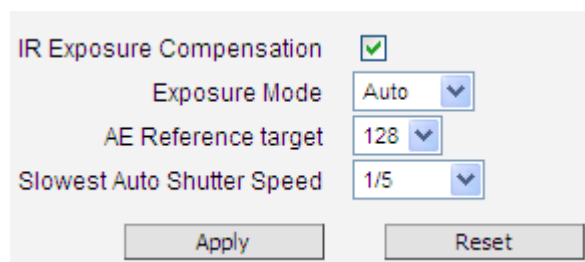

IR Exposure Compensation is available on all cameras with IR LEDs. This feature automatically balances the IR exposure to eliminate over-exposed images cause by too much IR on the subject. When enabled, the AE reference target is automatically adjusted to control the sensor's shutter speed and gain to compensate IR effect.

Exposure Mode -Auto

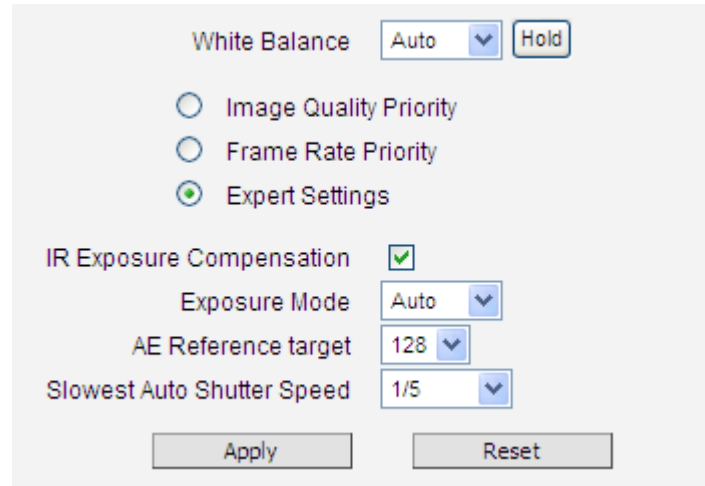

In Auto Exposure Mode, you control the image brightness by configuring the AE Reference Target and Slowest Auto Shutter.

AE Reference Target (Auto Exposure reference target) can be considered as the “Target Brightness on Sensor”. The camera will use several internal parameters to achieve best quality with reference to this. **The higher this value, the brighter the overall scene, however, there may be more noise at night in such case.** The range of AE Reference Target is 1~255.

The camera will automatically control shutter speed, auto iris (if available) and signal gain to achieve the target level set by the user. If the auto iris does not exist or is already opened to a maximum size, and the image is still darker than the user defined target, it will further slow down the shutter speed within the allowed range (set by user under Slowest Auto Shutter Speed) and increase the signal gain.

Slowest Auto Shutter Speed is the user defined threshold for slowest allowed speed of auto shutter. For example, if by default the shutter speed would vary between 1/5s ~ 1/2000s depending on the lighting conditions, then setting the Slowest Auto Shutter Speed to 1/30s would narrow down the auto shutter range to work between 1/30s ~ 1/2000s. The purpose of allowing user to define the threshold for slowest speed is to avoid motion blur caused by too slow shutter at night.

It is also important to know that very high shutter speed is not recommended for indoor solutions with artificial light that flashes with certain frequency, as it may produce flickering effect, regardless of Exposure mode.

In extreme low light conditions, the shutter speed is slowed down to get more light into one image, but not slower than the user defined threshold.

If the exposure time extends beyond the interval between frames (too slow shutter), (i.e. 1/30 second), then the frame rate will be automatically reduced. **Longer time in this value gives clearer images at night for slow moving objects, but more motion blur for fast moving objects.**

White balance refers to the capability of the camera to understand what “true white color is”. When the camera knows the true white color, then the rest of the colors will be accurate, too. While human eye can easily adapt to different lighting sources (even mixed sources, such as sun light through the window and indoor lights turned on at the same time), the camera has to

understand what is the dominant light source in given scene and what is the “white color” of such light source.

By default the camera is in **auto white balance** mode and attempts to recognize the light source and its color spectrum automatically and adjusts the image accordingly. This function works continuously in the background. It is re-evaluated for each frame, to make sure if there is any change in dominant light source (e.g. the user closes the curtains to block the sun light and turns on the indoor lights).

In most cases the auto white balance works perfectly and the user does not have to adjust anything! In some rare installation cases, especially when there are no white color objects in the field of view, and the light sources are mixed, the camera may have difficulty to identify the true white color to fine tune the rest of the colors.

In such cases, the installer can “help” the camera to understand the true colors by placing a white object (for example a piece of white paper) in front of the camera to cover the whole field of view and wait a few seconds – the auto white balance system will adjust the colors until the white paper will really look white on the display. At that moment, the user can freeze these white balance settings by pressing the **Hold** button. After pressing that button, the White Balance will switch from Auto mode to Manual mode, together with the color values captured at the moment of Hold. The user can now remove the white object from the field of view, and the colors will stay correct for given scene.

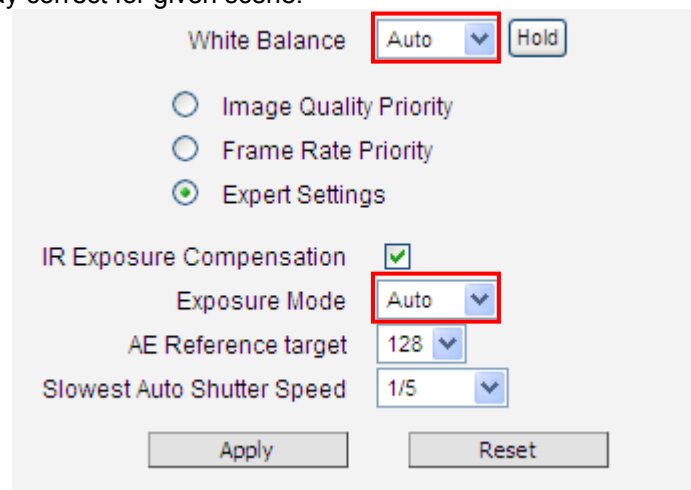

For advanced users, there is also an option to switch from Auto mode to **Manual mode** of White Balance directly and input the R Gain and B Gain values manually.

After changing any of the items above, press **Apply** to save the changes. The Reset button undoes the changes that had just been made but not Applied yet.

Exposure Mode - Manual

When the lighting conditions are stable 24 hours a day, the advanced users may consider using manual exposure mode, to further fine tune the image quality in order to fulfill the special project requirements. Please note that in most cases, it is highly recommended to keep the camera in Auto Exposure mode and let the intelligent system of the camera find the best possible exposure settings instead.

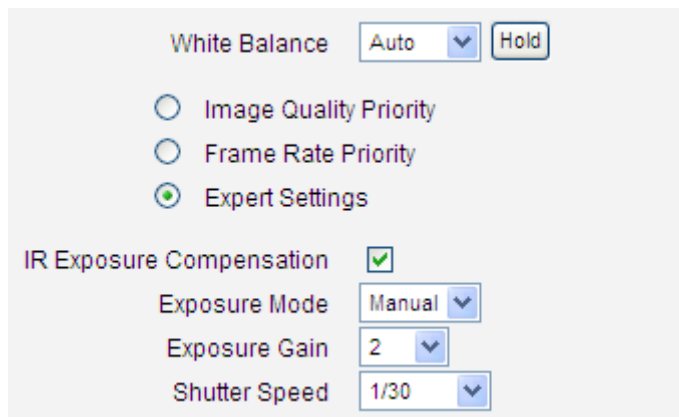

In manual exposure mode, the user can directly manually adjust the signal **Exposure Gain**, **Shutter Speed**, and even on select models, the **IRIS Control** (I-series zoom cameras only). The **White Balance** and **Line Frequency** controls have already been explained in the previous chapter.

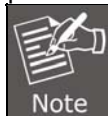

WDR is disabled in manual exposure mode.

After changing any of the items above, press **Apply** to save the changes. The **Reset** button undoes the changes that had just been made but not Applied yet.

OSD/Privacy Mask

The **OSD/Privacy Mask** section allows user to do one of the two on-video operations:

1. Add text to the upper or lower left corner of the video. This function is called **Text Overlay** or **On-Screen Display (OSD)**. It is possible to display the camera name, date and time, IP address or any custom text as Text Overlay. **The text is kept as small as possible and is not resizable.** The text can be read normally when the video is enlarged on the display to 1:1 ratio. The purpose of having the text so small is to provide sufficient legal evidence while blocking the smallest possible area of the video to avoid valuable video evidence being blocked by text overlay. The text will be embedded into video and cannot be removed later upon playback or export.
2. Cover up some sensitive areas of the video that should not be captured by the camera, such as manager's computer screen or bathroom entrance. This function is called **Privacy Mask**. It is possible to configure several independent regions for masking. **Microsoft Internet Explorer** browser is required to configure the Privacy Mask. The privacy masks will be embedded into video and cannot be removed later upon playback or export.

Text Overlay (OSD) Setup

It is possible to define up to 4 regions of text. If more than 1 region of text is **enabled** and positioned in the same location, then the texts will appear one below another, row by row.

OSD

Region	Enabled	Color	Transparent	Position	Format of Texts
1	<input checked="" type="checkbox"/>	Blue	50	Top	
2	<input type="checkbox"/>	Black	0	Top	
3	<input type="checkbox"/>	Black	0	Top	
4	<input type="checkbox"/>	Black	0	Top	

In the example above, one region of text was enabled with blue color and 50% transparency, located at left lower corner and containing the text of "Office View" together with current date. The date would be automatically changing every day, according to camera's date and time settings. The result of the example configuration would look like this (Live View page, 1:1 scale):



Below is the list of characters with special meaning that can be used in the text field:



Parameters	Description
%YYYY	Year in four-digit format. For example, 2008
%YY	Year in two-digit format. For example, 08
%MM	Month in two-digit format. For example, 01 for January, 12 for December
%DD	Date in two-digit format. 01~31
%hh	Hour in two-digit format. 00~23. Note that only 24-hour indication is supported.
%mm	Minutes in two-digit format. 00~59
%ss	Seconds in two-digit format. 00~59
%H	a hyphen, "-"
%C	a colon, ":"
%X	a slash, "/"
%N	show Camera Name (It might be truncated if exceeds max OSD length)

After changing any of the items above, press **Apply** to save the changes. The **Reset** button undoes the changes that had just been made but not Applied yet.

Privacy Mask Setup

This function puts blocks over parts of the cameras view that should not be seen. It is possible to set up up to 4 regions of privacy masks. The adjustment of the privacy mask region can be done when region is checked under "Setup" column.

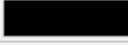
Privacy Mask (Don't overlap privacy mask regions)

Region	Enabled	Color	Setup
1	<input checked="" type="checkbox"/>		<input checked="" type="checkbox"/>
2	<input type="checkbox"/>		<input type="checkbox"/>
3	<input type="checkbox"/>		<input type="checkbox"/>
4	<input type="checkbox"/>		<input type="checkbox"/>

Apply Reset

You may resize and drag the region the same way as the motion detection regions: upper bar that contains the number of the region can be used for dragging the region across the video while the white box at the right lower corner of the privacy mask region can be used for resizing the region.

There are 4 pre-defined color options for privacy masks. If the user wants to use any other colors, please use URL commands to set up the privacy mask instead. To do that, please refer to the Guide that explains the use of URL commands.



When switching back to live view, the privacy mask would look like this:



Please note that the Text Overlay (OSD) and Privacy Masks will take effect for both Stream 1 and Stream 2.

After changing any of the items above, press **Apply** to save the changes. The **Reset** button undoes the changes that had just been made but not Applied yet.

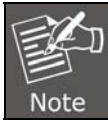

It may take several seconds to update the region location on video display after pressing Apply!

3.9.3 Audio

The **Audio** section is available only for audio-supported models. The user interface for audio control looks like below:

Parameters	Description
Audio In	The option "Enabled" would activate incoming audio (either line in or built-in microphone). The option "Disabled" would turn off the incoming audio. In such case, the video stream is captured without audio.
Audio Out Volume	The audio out volume level can be adjusted in the scale of 0-100. It will influence the volume level of the speakers connected to the camera.
Audio Format	Choose the compression format of audio: PCM, G.711A (<i>A-law</i>) or G.711U (<i>μ-law</i>).

3.10 Event

This section describes how to setup the Event Handler, which deals with how the IP devices respond to situations. Each IP device can have a maximum of 10 Event Rules. Each rule includes one single trigger, and one or many responses. Several types of responses are available. And there are multiple external servers for the device to interact with.

When setting up Event Handler, there are four types of settings. Event Server, Event Configuration, Event List and Manual Event

Click the **+** item before **Event** to expand the list.



3.10.1 Event Server

Event servers define whom the device may interact with. They can be other servers or devices on the network, or even the camera itself. **Event Configuration** sets up a list of what to tell the other party during interaction. Event list lays down the rules and conditions about when to initiate which responses from which triggers. **The options available for Event rules are selected from the event servers and event configurations.**

Event servers are classified as FTP servers, SMTP servers and HTTP servers

Event Server			
Type	Network Address	Ports	User Name
FTP Server Configuration	none	21	none
SMTP Server Configuration	none	none	none
HTTP Server 1 Configuration	none	80	none
HTTP Server 2 Configuration	none	80	none

FTP Server

FTP servers can receive snapshot or video uploads that are issued as part of the response from event handlers. You may setup one FTP server.

FTP Server Configuration

Network Address

Network Port

User Name

User Password

Mode

Max. Connection Time sec. (0~60 sec)

To setup FTP servers, make sure to enter the network address of FTP server, the Network (FTP) port, the User Name and Password of FTP account, Connection mode (Passive or Active) and Connection time before timeout.

After changing any of the items above, press **Apply** to save the changes. The Reset button undoes the changes that had just been made but not Applied yet.

SMTP Server

SMTP servers can send email upon request from the IP device. The email can be a simple subject and text email, or attached with snapshot/video. You may set up two SMTP servers. The device will first attempt to send the message via the Primary email SMTP server. If the first attempt fails (after the maximum connecting time), the device will attempt to send it via the secondary SMTP server. If the device sends email successfully via the primary SMTP server, then it will not use the secondary SMTP server.

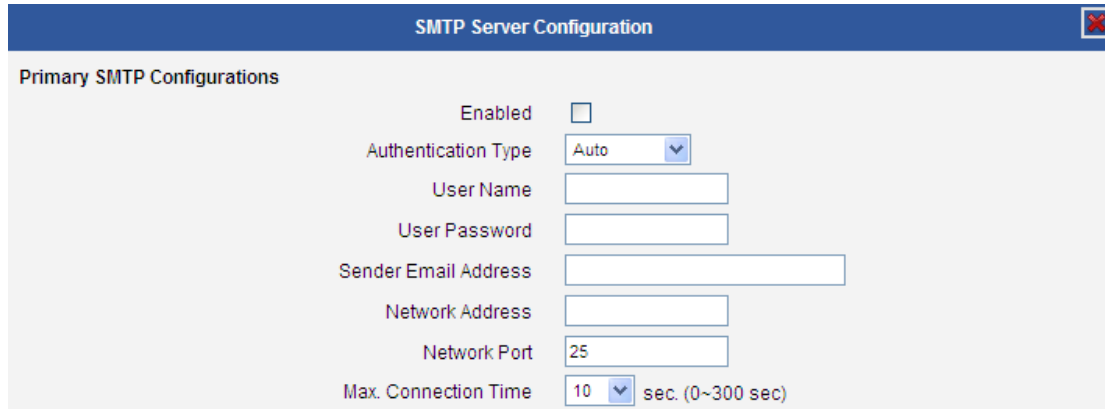

To setup SMTP servers, make sure to enable the SMTP account and choose the proper Authentication type. There are many types available. The default is Login. We recommend you to use Auto Detection. Available authentication types include: Auto Detection, None, Login, Plain, Cram MD5, Digest MD5 and PoP Relay. Please also enter the User Name, Password, the email address displayed as sender (can be different than the user name), Network (SMTP server) address, Network (SMTP server) Port number and Max Connection time before timeout (in [seconds](#)).

After changing any of the items above, press **Apply** to save the changes. The Reset button undoes the changes that had just been made but not Applied yet.

HTTP Server

HTTP CGI servers are programs that run on web sites or many devices. They can be custom-programmed to perform a large variety of actions based upon the input. You can define which CGI server to connect to here, and the user / password required to log into the target server. The actual message/command is setup in the Notification messages/URL commands section. You may define two separate CGI servers.

IP devices are also CGI servers. This means that IP devices can now issue commands to each other, which creates endless possibilities for highly coordinated response. The IP device can also give a loopback command to itself, in effect changing almost all possible settings dynamically. For detail on the commands used to control the cameras, please contact your customer representative.

An example will help you gain a better sense of how to utilize this unique function. Camera A is a fixed camera that looks at a corridor leading to the main hall. It has a motion detection window located near the point where the corridor arrives at the large hall. Camera B is a PTZ camera located in the hall, which is usually left on auto-tour patrol. When motion activity in the motion detection region triggers MD1 in Camera A, this then in turn activates an event rule in Camera A that gives out a command to Camera B. Camera B would then swivel to the preset point where the corridor leads into the entrance and switch to higher bit rate to temporarily provide clearer image. After the event ends, Camera B will go back to its normal routine in lower bit rate.

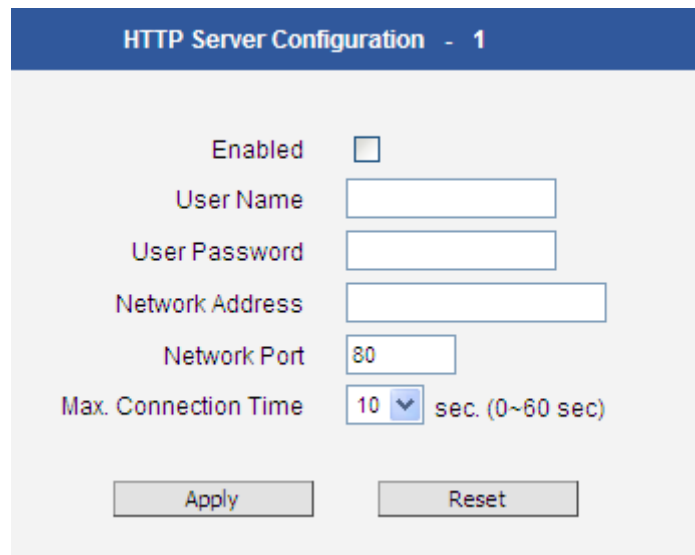

To setup HTTP servers, make sure to enable the HTTP server, enter the user name, the user password, Network (HTTP Server) address, Network (HTTP Server) port number and Max connection time before timeout (in seconds).

After changing any of the items above, press **Apply** to save the changes. The Reset button undoes the changes that had just been made but not Applied yet.

3.10.2 Event Configuration

Event configurations are the responses to be performed when an event is triggered. For most types of responses, you can create several different preset responses, then mix and match in event rules.

The configurable responses are classified as Digital I/O ports, Notification messages, Upload Video/Snapshot and Audio and Send URL Commands.

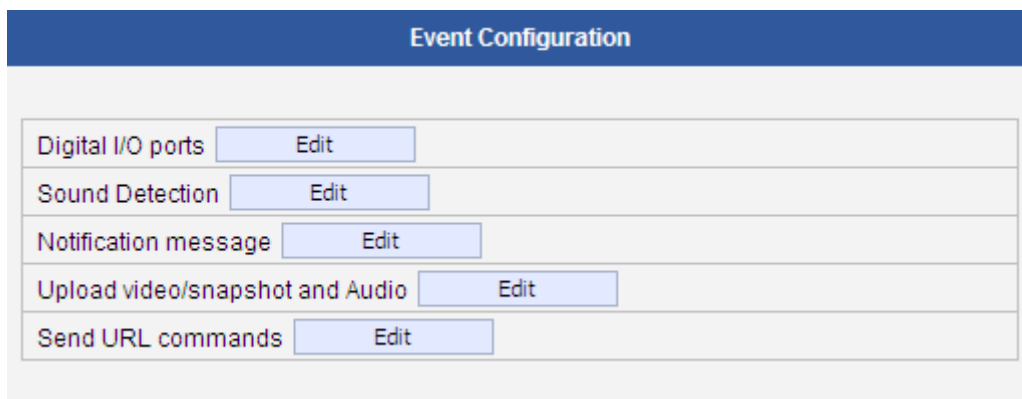

Event Configuration	
Digital I/O ports	Edit
Sound Detection	Edit
Notification message	Edit
Upload video/snapshot and Audio	Edit
Send URL commands	Edit

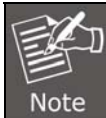

Digital I/O ports appear only for the camera models that support this function.

Digital I/O ports

Digital input/output ports (select models only) are used to connect digital input (DI) and digital output (DO) devices. DI is a trigger device like a switch or sensor (e.g. “panic button”), which when pressed or triggered, notifies the camera to perform specific actions or the DO device to respond. DO’s can be alarms or lights, etc.

Digital I/O ports
✖

Digital Input Port

Port	Active Level	Interval (0~86400 seconds)
DI 1	0 ▾	0

Digital Output Port

Port	Active Level	Interval* (0~86400 seconds)
DO 1	1 ▾	0

*: When 0, the digital output port stays at active level until the associated event becomes inactive

The Digital I/O Ports page displays the number of available DI and DO ports on the camera, which varies depending on camera model.

DI: To configure the digital input device, define the active level and trigger interval of the DI. The default **Active Level** is “0”, which means the DI device remains inactive unless triggered. A good example is a “panic button”, which always stays in inactive mode “0” until the button is pressed; when the button is pressed, its active level becomes “1” which means the DI is triggered. Active level “1” returns back to “0” (inactive mode) after the specified **Interval**. The **Interval** is the duration of time when the trigger remains in active mode which is also the minimum time interval between the previous trigger and the next. For example, if the interval is set to “5 seconds”, the DI will not respond if the “panic button” is pressed within 3 seconds after the previous trigger. To issue another trigger, press the button after 5 seconds from the previous trigger.

DO: To configure the digital output device, define the active level and response interval. The default **Active Level** is “1”, which means the DO will turn to active mode and respond once triggered. The duration of its response will last according to the set **Interval**. A good example is an alarm siren, wherein the siren will start sounding only when it is triggered by an event or another device like a DI. The siren will stop sounding once the set interval time elapsed.

After changing any of the items above, press **Apply** to save the changes. The Reset button undoes the changes that had just been made but not yet applied or saved.

Sound Detection

Sound detection is available on cameras with Audio in capability and is shown on the user interface only if the **Audio In** function is enabled in **Audio** setup menu. Sound detection is used to trigger the camera or another camera to perform specific actions or a digital output device, such as alarms or lights, etc. to respond.

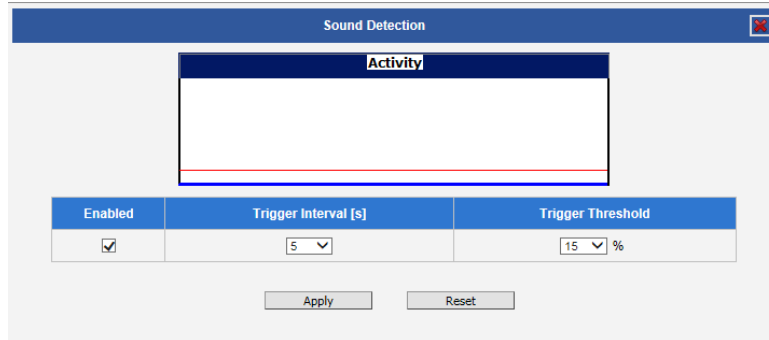

Check the **Enabled** box to enable **Sound Detection**.

The **Trigger Interval** refers to the time interval of the first detected sound to the next detected sound. For example, if trigger interval is set at 5 (seconds), the next sound detection is triggered only after 5 seconds. If the next sound is detected 3 seconds after the first sound, the trigger is not activated.

To set the range or loudness of sound, set the **Trigger Threshold**. This helps define which sound is considered loud enough to be a trigger. For example, the sound of blowing wind should not be considered, while the sound of a door creaking is a cause for alarm. The red line on the Activity graph shows the threshold set at 15%. The blue graph shows the sound activity. If the blue graph exceeds the red line, sound is triggered.

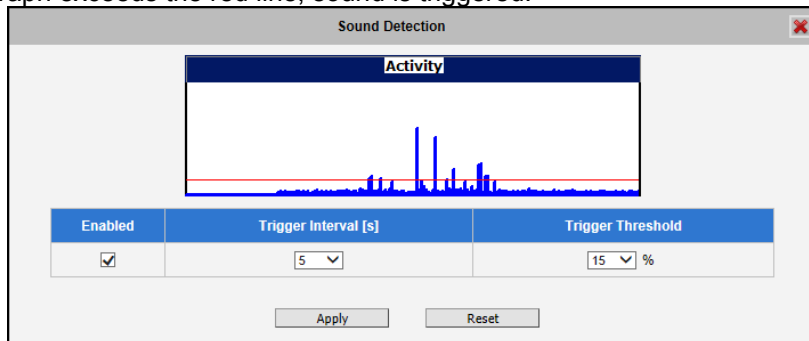

How to choose the most optimal trigger threshold level. The rule of thumb, **keep the trigger threshold as small as possible while not causing false alarms**.

After changing any of the items above, press **Apply** to save the changes.

Notification message

*Pre-requisites: **SMTP server / HTTP CGI server setup**.

Notification messages may be sent to either an email or a HTTP CGI server. If sent to a CGI server, it works the same as an URL command, but it does not allow a second message at end of event. You may configure up to three preset messages. You can configure a message, but disable it. This will allow you to keep the settings without using it, which will be useful in testing and troubleshooting.

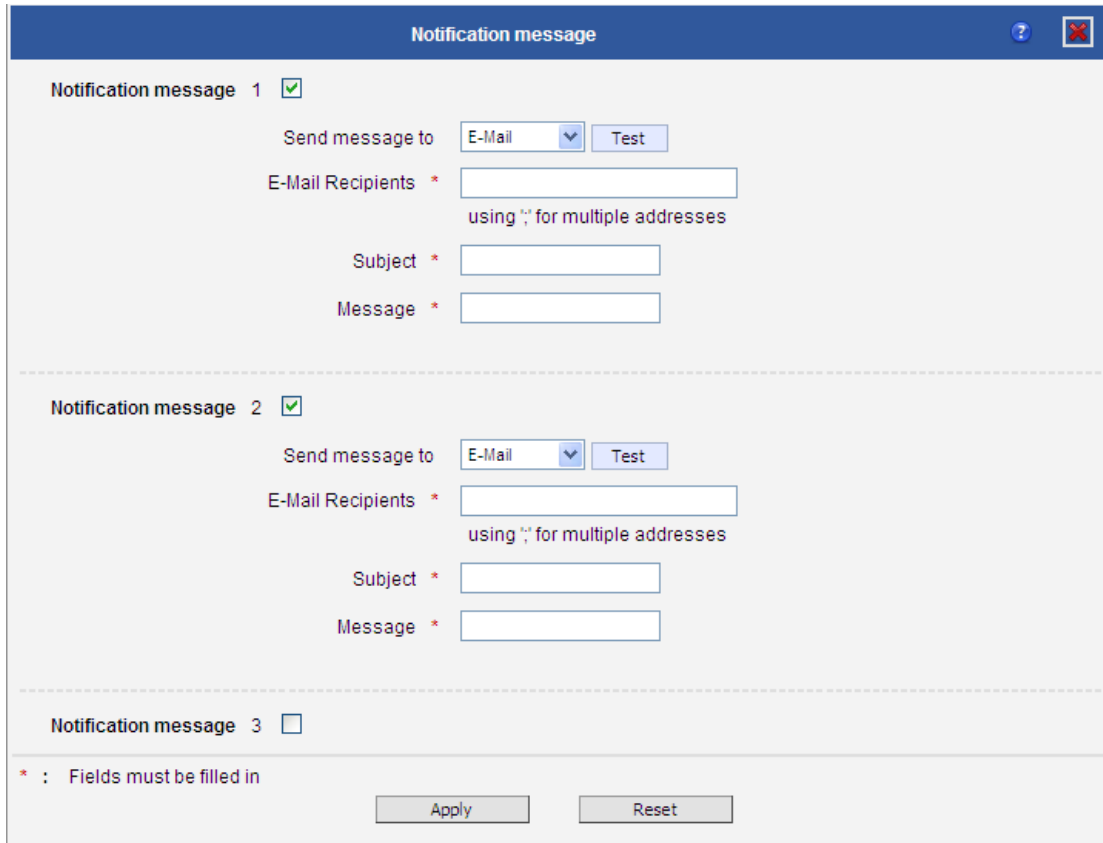

The screenshot shows a web interface titled "Notification message" with three sections for configuring messages:

- Notification message 1**: Enabled (checked). Fields include "Send message to" (E-Mail selected), "E-Mail Recipients" (with a note "using ',' for multiple addresses"), "Subject", and "Message".
- Notification message 2**: Enabled (checked). Fields include "Send message to" (E-Mail selected), "E-Mail Recipients" (with a note "using ',' for multiple addresses"), "Subject", and "Message".
- Notification message 3**: Disabled (unchecked). No fields are visible.

A legend at the bottom left states: "* : Fields must be filled in". "Apply" and "Reset" buttons are located at the bottom center.

To set up Notification Messages, make sure to enable the message and then determine what type of message to send (HTTP CGI or email).

If you are sending to CGI server, you need to enter the CGI path, the URL command itself, and an optional message.

If you are sending email, please enter the recipient e-mail address, the email subject, and the body message.

After changing any of the items above, press **Apply** to save the changes. The Reset button undoes the changes that had just been made but not Applied yet.

Upload Video/snapshot and Audio

***Pre-requisites: SMTP server / FTP server / HTTP CGI server setup.**

IP devices may send video recording / snapshots to your chosen server upon event. Video will be in .RAW format, while snapshots will be .JPG files. You can define up to three groups of settings to upload video/snapshot. Snapshots can be sent to FTP/HTTP CGI, e-Mail, or local storage (for select models only), while video can only be uploaded to FTP, HTTP CGI servers, or local storage (for select models). If Audio in is enabled in device, the uploaded video will include audio.

The parameters needed to setup this function are different for each task combination (snapshot/FTP or video/HTTP, etc), and are explained below:

Enable							UI
							Upload video/snapshot and Audio 1 <input checked="" type="checkbox"/>
Upload Media Type	Snapshot			Video			Upload Media Type <input checked="" type="radio"/> Snapshot <input type="radio"/> Video
Upload Media to	Email	FTP	CGI	FTP	CGI	Local	Upload Media To E-Mail
Upload Period	Y	Y	Y	Y	Y	Y	Upload Period 0 (0~86400 seconds)
Image during Upload Period	Y	Y	Y				Images during Upload Period 0 (Use 0 for maximum number of images)
Pre-Buffer Time				Y	Y	Y	Pre-Buffer Time 0 (0~10 Second)
Image File Name	Y	Y	Y	Y	Y		Image File Name Front_Door_%YYYY_%MM_%DD
Upload Path		Y	Y	Y			Upload Path Camera/%N
CGI Path & Program			Y		Y		CGI Path & Program
E-Mail Recipients	Y						E-Mail Recipients using ; for multiple addressed
Subject	Y						Subject Front Door Snapshot
Video Source	Y	Y	Y	Y	Y	Y	Video Source 1

Upload Video/snapshot and Audio checkbox: This decides if this rule is in effect, or disabled. Sometimes it is useful to keep the settings for troubleshooting purposes, but keep them as disabled.

Upload Media to: These define the task at hand, and change the field that needs to be filled out.

Upload Period: IP device will provide video/snapshots for the number of seconds here. It will stop uploading video/snapshot at the end of this period. If you have video management software recording from this camera at the same time, the normal recording through NVR will not be affected, and goes on throughout the event period and afterwards. But the special upload session will end as the event ends.

Image during Upload Period: This is used only by snapshots. This tells the camera how many snapshots it should attempt to capture during the Upload Time. If this value is set to 0, then the IP device will attempt to capture as many snapshots as possible. Depending upon the device loading, the number of snapshots taken may not reach the number you specified.

Pre-Buffer Time: This is only used by video. If this is set to more than 0, then the IP device will start to buffer video in its internal memory. The maximum pre buffer is **10 seconds**. When an event requires video upload, the IP device will first upload the video taken right before the event then keep uploading until it reaches the upload time.

Image File Name/ Upload Path: You will need to specify rule for file names and upload paths (upload path is not needed for Email. Just put a slash “/” in the field). The rules contain flexible parameters. A sample rule and corresponding filename will look like this:

Front_Door_%YYYY_%MM_%DD@%hh%mm%ss
Front_Door_2009_10_12@195037.JPG

Upload Path folders may also be named dynamically. For the IP device to create folders on FTP and HTTP CGI servers properly, your FTP/CGI account will need to have permission to create folders. For syntax on auto naming, please see online help or the inset box at the end of this section.

The symbol “%” cannot be the first character in filename or upload path. Please use either an alphabet or a number as the starting character. For Upload Path, be sure to start and end eight a backslash“\”. An example will be : \Backgate%MM%DD\

CGI path & Program: Some CGI servers may require special info and settings. Please refer to CGI server designer for this section. IP devices do not allow upload of Snapshots / Video into their embedded CGI servers.

E-Mail Recipient/Subject: When uploading video/snapshots via email, these fields are required.

Auto Naming Rules for Files and Folders:

To properly track images and videos, a well-thought naming rule is necessary. There are a number of automatic variables available to design a proper naming system, which may be used both on files and folders.

Symbol	Description	Example
%YYYY	4 digits for year	2009 for year 2009
%YY	the last 2 digits of 4 digits year	09 for year 2009
%MM	two digits for month. 01~12	01 for January
%DD	two digits for date. 01~31	01 for the 1st day of a month
%hh	two digits for hour. 00~23	
%mm	two digits for minute. 00~59	
%ss	two digits for second. 00~59	
%W	a space character. ' '	' '
%N	camera name	camera-1
%Y	File serial counter. It starts from 1 in every uploading task. The counter will be increased by 1 for next uploading file.	1,2,3,4,5,...

Example

1. Entrance-%YYYY-%MM-%DD@%hh%mm%ss for time 2009/06/05 22:50:30.

The full name is Entrance-2009-06-05@225030

2. X_%w-%N_TEST%Y for camera name is 'my-camera' and three successive uploaded files.

The full names of these three files are

X_ -my-camera_TEST1, X_ -my-camera_TEST2, X_ -my-camera_TEST3

Video Source: Choosing the video source from video 1 or video 2.

Send URL commands

*Pre-requisites: **HTTP CGI server setup.**

URL commands can be sent to HTTP CGI servers upon event. This provides the possibility of highly intelligent response upon event. IP devices and many other devices also have embedded CGI servers that may be controlled.

When Event Handler sends an URL command, it will send one set of command when the event is triggered, and another as the event becomes inactive. Depending on the CGI design, the URL commands may be able to be stringed together, and multiple commands may be issued in a single line.

An example would be when the access control device at the entrance detects an entry, this device provides a DI signal to the PTZ camera, and triggers an event. This event then sends a loopback command to the PTZ Camera itself (by setting its own IP as the HTTP CGI server). The PTZ Camera then moves to a preset location, stays until the event is over, and then moves back to another location. At the same time it moves to the pre-set location, it increases the bitrate from 1M to 3M, and the frame rate from 4 fps to 8 fps. The bitrate / fps changes are reverted at the end of event.

3.10.3 Event List

You may define a maximum of 10 Event rules, which will be shown in abbreviated form in the Event List panel. It will display under each Event ID, the days of the week it will be active, the start time and duration of the active period, the type of the source of trigger, and the actions used in the response. If the row is grayed out, this means the rule is currently not enabled and stays inactive.

Event List						
ID	Week Day	Start	Duration	Source	Action	
1	1234567	00:00	24:00	MD1	MSG1	
2	1234567	00:00	24:00	SCH	NONE	
3	1234567	00:00	24:00	SCH	NONE	
4	1234567	00:00	24:00	SCH	NONE	
5	1234567	00:00	24:00	SCH	NONE	
6	1234567	00:00	24:00	SCH	NONE	
7	1234567	00:00	24:00	SCH	NONE	
8	1234567	00:00	24:00	SCH	NONE	
9	1234567	00:00	24:00	SCH	NONE	
10	1234567	00:00	24:00	SCH	NONE	

You may start creating a new event by clicking the event ID number in the list, for example “2”. There are several parts to the Event rule:

When is it active?

You may choose to enable the rule or not. The settings will be kept in internal memory even if the event rule is disabled. Select the days in a weekly cycle in which this rule and schedule is active.

Determine the start time and duration of the active period. For example, a rule that lets motion detection trigger snapshot uploads to FTP would only take place after 19:00 each day for 12 hours. Outside of this time the rule will not be active.

In the example below, the event handler rule is active 24 hours a day, 7 days a week.

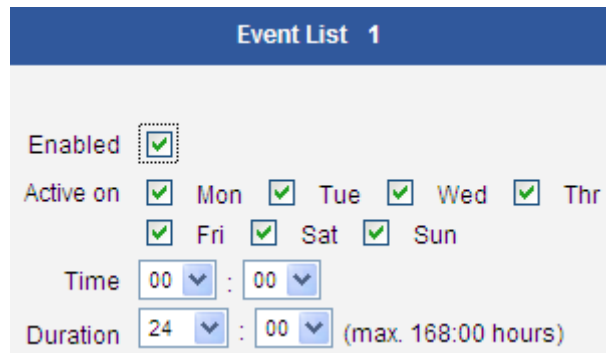

Event List 1

Enabled

Active on Mon Tue Wed Thr
 Fri Sat Sun

Time 00 : 00

Duration 24 : 00 (max. 168:00 hours)

How is it triggered?

Events may be triggered by one of the several sources.

Scheduler: You can trigger an event based on the set schedule. For example, in the example below, the schedule is set for an alarm to sound at 4:00, and will sound once every 5 minutes within the next 10 minutes.

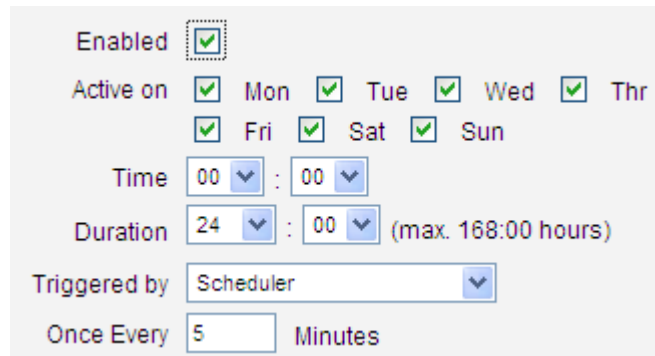

Enabled

Active on Mon Tue Wed Thr
 Fri Sat Sun

Time 00 : 00

Duration 24 : 00 (max. 168:00 hours)

Triggered by Scheduler

Once Every 5 Minutes

DIs: For selected models only, the IP device may be triggered by Digital Input. Select the digital input and make sure to configure it on the **Event Configuration** page

Motion: You may trigger the event if one or many Motion Detection regions encounter a motion trigger. Trigger from any of them will initiate the event. The duration of event will be the same as the MD trigger length, or the Trigger interval time, defined in the Motion Detection section on Video Adjust page. In the example below, Motion Detection region 1 is used as the event trigger.

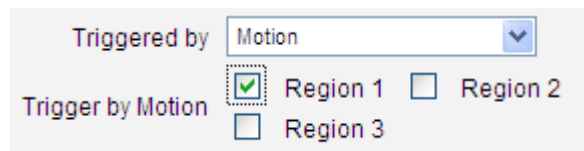

Triggered by Motion

Trigger by Motion Region 1 Region 2
 Region 3

You may also ask the event to be repeatedly triggered during this scheduled time. The interval is determined in minutes. You may use this with email / FTP upload to take snapshots at regular intervals.

Sound Detection: The event may be triggered when sound is detected. This feature is available on cameras with Audio in capabilities only. The Sound Detection must be configured first to use this feature.

Switch to Night mode: This is available to selected models only. When camera changes between day and night modes, the embedded event handler will notice this change, and may act upon this information.

Potential uses include changing the motion detection profile to another set of Event MD parameters. By having two sets of parameters each optimized for day and night, this provide better overall accuracy in both day and night conditions. Some night time only MD regions may also be activated this way. The event period will end when the camera returns to day mode, which will then reset the camera to the original settings.

Device boots successfully: This will trigger the event responses once the device boots up. You can use this to create a notification system that keeps record of when the device has been rebooted via email.

Reboot device: This triggers the event response when the device is shut down via web UI "Save and Reboot". Use this to keep record of when was the device setting edited. Note that this will not take effect when the device is unplugged, as this is not normal shutdown.

Fail to write storage (with storage card only): Trigger occurs when there is an error in writing data to the memory card.

Remove storage media (with storage card only): Trigger occurs when the memory card is suddenly removed from the device.

What responses will occur?

Available responses vary depending on what triggered the event.

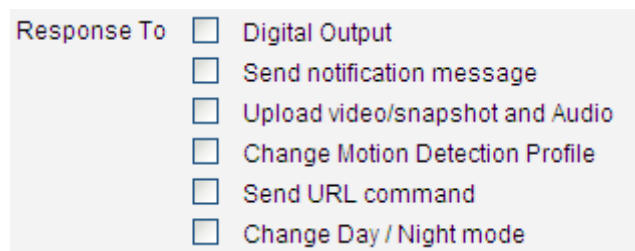

Response To

- Digital Output
- Send notification message
- Upload video/snapshot and Audio
- Change Motion Detection Profile
- Send URL command
- Change Day / Night mode

Digital Output (selected models only): This is a useful link to other devices. Click to include this in the response for this rule.

Send notification Message: Select from the three pre-defined messages which you've setup in the Event Configuration section. You may enable multiple messages at the same time. For sending Email, please limit the recipient to one per event rule. If you need to send email to more than one recipient, please use separate event rules triggered by the same trigger.

Upload video/snapshots: Select which of the event configurations to include in this response set. If you are sending email via upload video and sending notification message at the same time, the system will automatically merge the two emails into one. The subject and image will be based upon the Upload snapshot Event configuration enabled, but the message in the body text will be based upon the Notification messages.

In general, please stick to the "one email per event rule" limit for best performance.

Change Motion Detection profile: This will switch the profile of the selected Motion Detection region from Runtime profile to Event profile. The profile will return to runtime settings at the end of this event. You may program one motion detection region to be disabled at runtime, but enable it with event handler under some circumstances.

Send URL command: Select the URL command to include in the response set. Two different commands will be sent at the time when the event is triggered and un-triggered. For example, going to a preset point, if the device is a PTZ camera, and there are preset points already configured in PTZ setup page, then you may include this in the response section of the event rule by using Send URL Command method. It is possible to let the camera return to another preset point at the end of the event.

Change to Day/Night Mode (Selected models only): For some models, you may force the Camera into Day or Night mode. The camera will return to its previous setting (whether auto or forced day/ night) upon the end of the event.

After changing any of the items above, press **Apply** to save the changes. The **Reset** button undoes the changes that had just been made but not Applied yet.

3.10.4 Manual Event

You may select one event in the Manual Event area below to be triggered via web user interface.

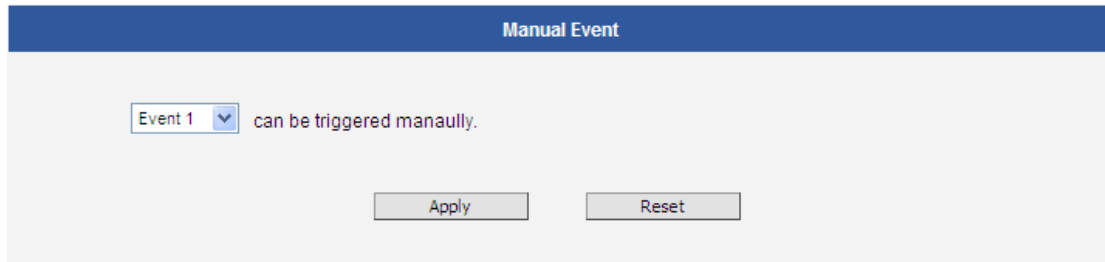

After changing any of the items above, press **Apply** to save the changes. The **Reset** button undoes the changes that had just been made but not Applied yet.

Once selected, the trigger button on the video display screen will show as clickable. Click to trigger the selected event. This is useful during event rule testing.

The live view panel would look like this:



3.11 System

The **System** section provides the list of functions that help manage the camera. The [+] mark before System indicates that the list can be expanded by clicking on it. Once expanded, the list can later be collapsed again by clicking on the [-] mark.

3.11.1 User Account

The User Account section allows doing the following user management tasks:

1. Change the account name or password of the Root account that has a full access to the camera.
2. Create up to 10 common users that only have an access for live view and PTZ control.

3. Enable/disable the option of seeing the live view without needing user name and password (anonymous login), which is especially convenient function for camera installers on the field. For security reasons, account name and password is always required when entering Setup page of Web Configurator or when trying to access camera or change settings by URL commands.

User Account

Live view without account name and password

User	Account	Password
Root	<input type="text" value="admin"/>	<input type="text" value="admin"/>
User 1	<input type="text"/>	<input type="text"/>
User 2	<input type="text"/>	<input type="text"/>
User 3	<input type="text"/>	<input type="text"/>
User 4	<input type="text"/>	<input type="text"/>
User 5	<input type="text"/>	<input type="text"/>
User 6	<input type="text"/>	<input type="text"/>
User 7	<input type="text"/>	<input type="text"/>
User 8	<input type="text"/>	<input type="text"/>
User 9	<input type="text"/>	<input type="text"/>
User 10	<input type="text"/>	<input type="text"/>

After changing any of the items above, press **Apply** to save the changes. The Reset button undoes the changes that had just been made but not Applied yet.

3.11.2 System Info

The **System Info** section provides the full information about camera status, settings and log. This information is very helpful while doing the camera configuration, maintenance or troubleshooting.

System Information

System Information :

Firmware Version = A1D-500-V8.09.31-NB
 MAC Address = 00:30:4F:0F:EE:4D
 Factory Default Type = Two Ways Audio (0x71)
 Company Name = PLANET Technology Corporation
 WEB Site = www.planet.com.tw
 Build Revision = 1
 PTZ_IMAGE = None
 PT_ENABLE = 0

WAN Status :

WAN_NETMASK='255.255.255.0'
 WAN_GATEWAY='192.168.1.254'
 DNS_PRIMARY='8.8.8.8'
 DNS_SECONDARY=""
 MAC='00:30:4F:0F:EE:4D'
 BONJOUR_CONFIG='1,ICA-E3550V'
 LLIP='169.254.39.108'
 IPv6='fe80:0000:0000:0000:020f:7cff:fe0f:ee4d/64'

System Log :

Mount jffs2 filesystem
 Loading System Config files ...
 Bootloader Version BOOTLOADER-500-V01.15
 Starting network interface ...
 Starting 802.1x Authentication ...
 802.1x disabled.
 Loading GetJiffies driver
 Initiating factory button ...

Config file:

The unit's parameters and their current settings. Parameter List

Always attach the server report when contacting your support channel. Server Report

Third party software licenses. Show License

The **Server Report** is a convenient way of exporting the full list of camera related information in a text format, so that it can be sent to the technical support team for faster service.

3.11.3 Factory Default

The **Factory Default** section allows the camera settings be reset to the original factory settings.

Factory Default

Preserve network setting and HTTP/HTTPS port.
 Reset parameters to the original factory settings.

If you want to keep network settings and restore other settings to factory default, please select the first option. If you select the second one instead, all the settings would be removed during factory default. You will have to use factory default IP setting to connect to this camera.

3.11.4 Firmware Upload

The **Firmware Upload** section allows remote upgrade or downgrade of camera firmware. The upgrade to newer version is usually done in order to gain new functions or fix existing bugs or limitations while downgrade to older version is used mostly for integration purposes where the newly purchased camera model comes with the newer firmware version than supported by a third party video management system of a given project.

The firmware image file can be downloaded from the website. It has the file extension “.upp”.

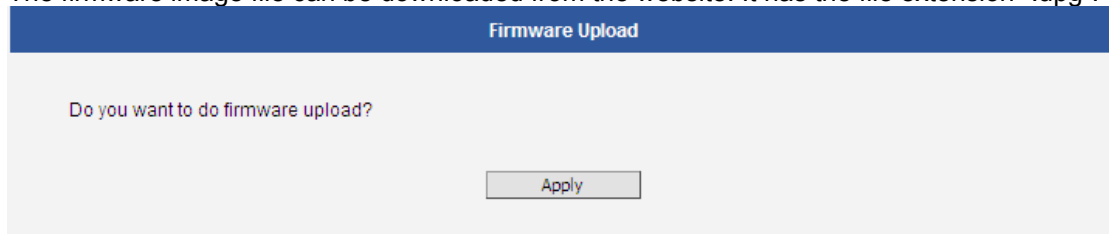

The screenshot shows a web interface titled "Firmware Upload". Below the title bar, the text "Do you want to do firmware upload?" is displayed. At the bottom center, there is a single button labeled "Apply".

After pressing **Apply** button, it is possible to browse for firmware image file that has already been downloaded to the computer that has the Web Configurator running.

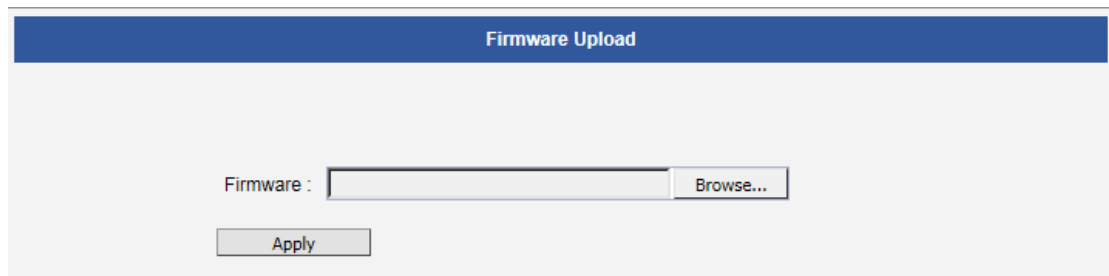

The screenshot shows a web interface titled "Firmware Upload". Below the title bar, there is a text input field labeled "Firmware :". To the right of the input field is a button labeled "Browse...". Below the input field and button, there is an "Apply" button.

Click **Browse** to select the upload image file. Click the **Apply** button to start the upload. Once the process is finished, you will get an “OK” message and system will reboot itself.

3.11.5 Save & Reboot

The **Save & Reboot** section allows saving the settings and rebooting the camera remotely. This is critical because some settings might not take effect before save & reboot.

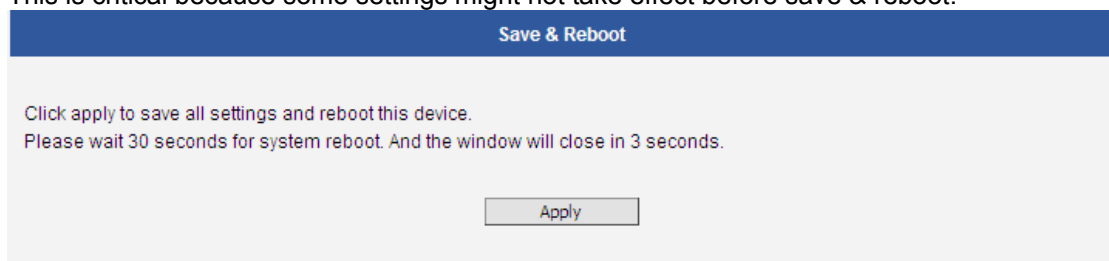

The screenshot shows a web interface titled "Save & Reboot". Below the title bar, the text "Click apply to save all settings and reboot this device." is displayed, followed by "Please wait 30 seconds for system reboot. And the window will close in 3 seconds." At the bottom center, there is a single button labeled "Apply".

3.11.6 Logout

Clicking this item allows you to log out of the IP device. Be sure to logout this IP device once you have completed all the tasks via Web Configurator.

Appendix A. Factory Default

To recover the default IP address and password, please follow the steps:

- Remove the upper cover; the Ethernet cable is still connected.
- Press and hold the reset button over 5 seconds. Do not release the button until power LED (red) lights up solidly.

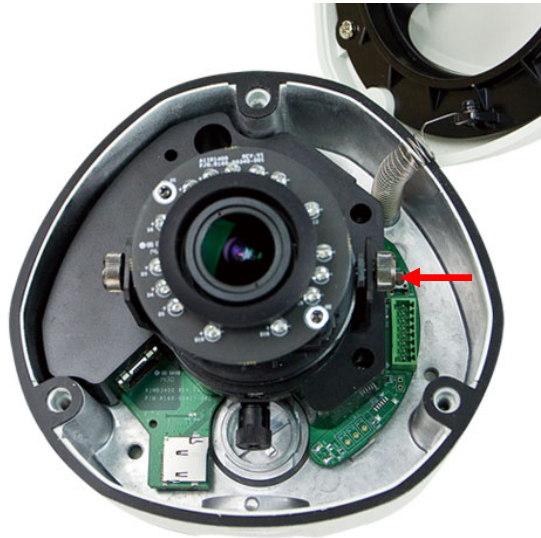

ICA-E5550V

- Replace the upper cover.
- Login the camera using the default IP (<http://192.168.0.20>) where both user name and password are **admin**.

Appendix B. Ping IP Address

The ping (stands for Packet Internet Groper) command is used to detect whether a specific IP address is accessible by sending a packet to the specific address and waiting for a reply. It's also a very useful tool to confirm whether or not Internet camera is installed or if the IP address conflicts with any other device over the network.

If you want to make sure the IP address of Internet camera, utilize the ping command as follows:

- Start a DOS window.
- Type ping x.x.x.x, where x.x.x.x is the IP address of the internet camera.

The replies, as illustrated below, will provide an explanation to the problem.

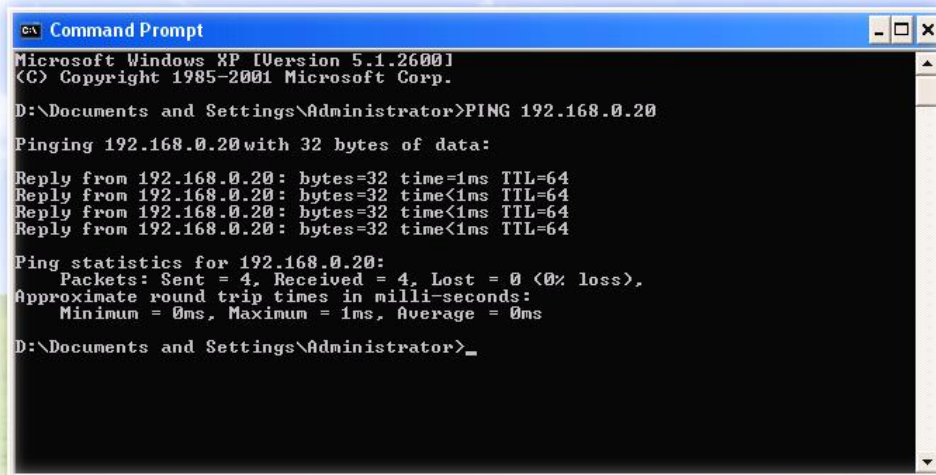

```
Microsoft Windows XP [Version 5.1.2600]
(C) Copyright 1985-2001 Microsoft Corp.

D:\Documents and Settings\Administrator>PING 192.168.0.20

Pinging 192.168.0.20 with 32 bytes of data:

Reply from 192.168.0.20: bytes=32 time=1ms TTL=64
Reply from 192.168.0.20: bytes=32 time<1ms TTL=64
Reply from 192.168.0.20: bytes=32 time<1ms TTL=64
Reply from 192.168.0.20: bytes=32 time<1ms TTL=64

Ping statistics for 192.168.0.20:
    Packets: Sent = 4, Received = 4, Lost = 0 (0% loss),
    Approximate round trip times in milli-seconds:
        Minimum = 0ms, Maximum = 1ms, Average = 0ms

D:\Documents and Settings\Administrator>_
```

If you want to detect any other device that conflicts with the IP address of Internet camera, you also can utilize the ping command but you must disconnect the Internet camera from the network first.

Appendix C. Planet DDNS Application

Configuring PLANET DDNS steps:

Step 1: Visit DDNS provider's web site and register an account if you do not have one yet. For example, register an account at <http://planetddns.com>

Step 2: Enable DDNS option through accessing web page of the camera.

Step 3: Input all DDNS settings.

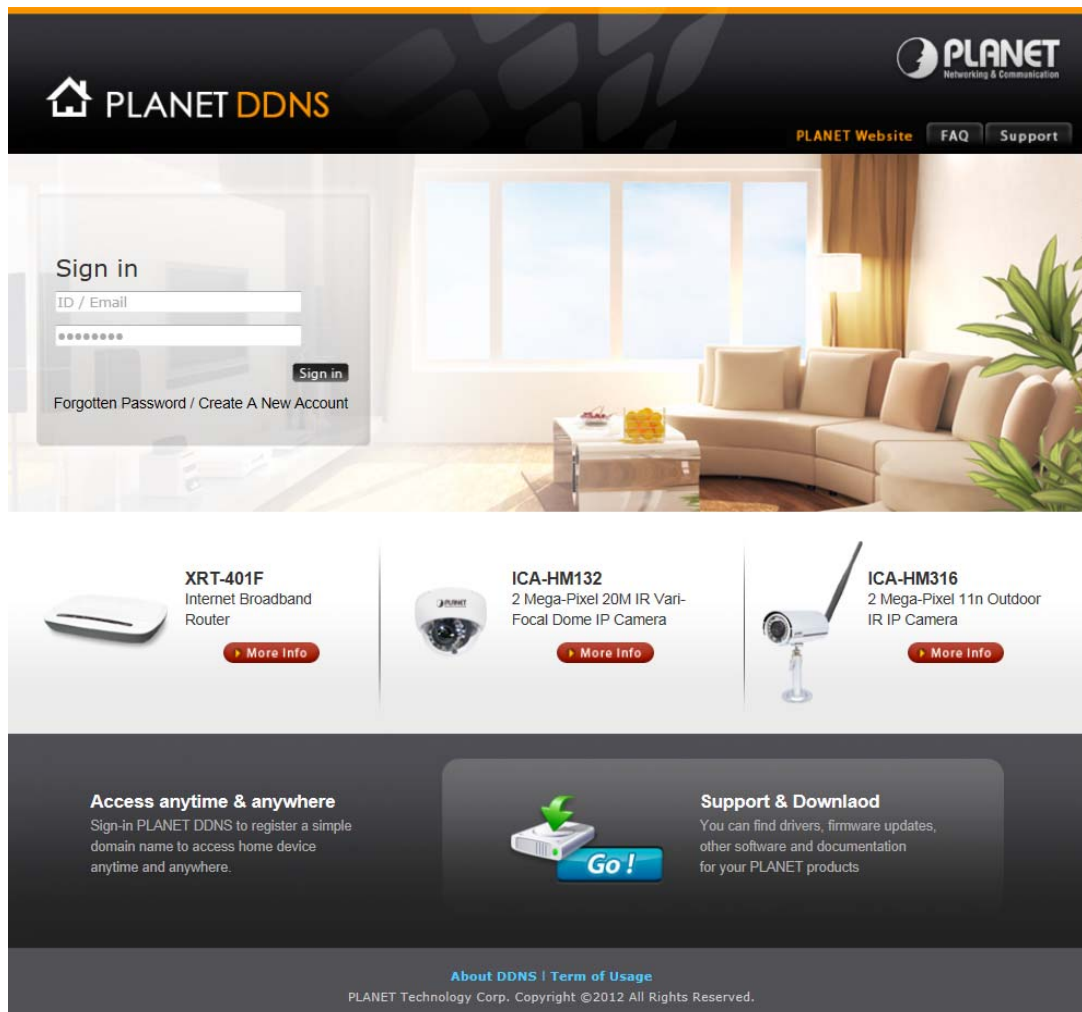

The screenshot shows the PLANET DDNS website. At the top, there is a navigation bar with the PLANET logo and links for 'PLANET Website', 'FAQ', and 'Support'. Below the navigation bar is a large banner image of a living room. On the left side of the banner, there is a 'Sign in' form with fields for 'ID / Email' and a password field, and a 'Sign in' button. Below the form are links for 'Forgotten Password / Create A New Account'. Below the banner, there are three product cards: 1. XRT-401F Internet Broadband Router with a 'More Info' button. 2. ICA-HM132 2 Mega-Pixel 20M IR Vari-Focal Dome IP Camera with a 'More Info' button. 3. ICA-HM316 2 Mega-Pixel 11n Outdoor IR IP Camera with a 'More Info' button. At the bottom, there is a dark grey section with two columns: 'Access anytime & anywhere' with a sub-header and text, and 'Support & Download' with a sub-header and text. A 'Go!' button is positioned between these two columns. At the very bottom, there is a footer with the text 'About DDNS | Term of Usage' and 'PLANET Technology Corp. Copyright ©2012 All Rights Reserved.'

Appendix D. Configuring Port Forwarding Manually

The device can be used with a router. If the device wants to be accessed from the WAN, its IP address needs to be set up as a fixed IP address. The port forwarding or Virtual Server function of router also needs to be set up. This device supports UPnP traversal function. Therefore, user could use this feature to configure port forwarding of NAT router first. However, if user needs to configure port forwarding manually, please follow the steps below:

Manually installing the device with a router on your network is an easy 3–step procedure as follows:

1. Assign a local/fixed IP address to your device
2. Access the Router with Your Web browser
3. Open/Configure Virtual Server Ports of Your Router

1. Assign a local/fixed IP address to your device

The device must be assigned a local and fixed IP Address that allows it to be recognized by the router. Manually setup the device with a fixed IP address, for example, *192.168.0.100*.

2. Access the Router with Your Web browser

The following steps generally apply to any router that you have on your network. PLANET wireless AP is used as an example to clarify the configuration process. Configure the initial settings of the router by following the steps outlined in the router's **Quick Installation Guide**.

If you have cable or DSL service, you will most likely have a dynamically assigned WAN IP address. 'Dynamic' means that your router's WAN IP address can change from time to time depending on your ISP. A dynamic WAN IP address identifies your router on the public network and allows it to access the Internet. To find out what your router's WAN IP address is, go to the **Status** screen on your router and locate the WAN information for your router. As shown on the following page the WAN IP address will be listed. This will be the address that you will need to type in your web browser to view your camera over the Internet. Be sure to uncheck the **Reset IP address at next boot** button at the top of the screen after modifying the IP address. Failure to do so will reset the IP address when you restart your computer.

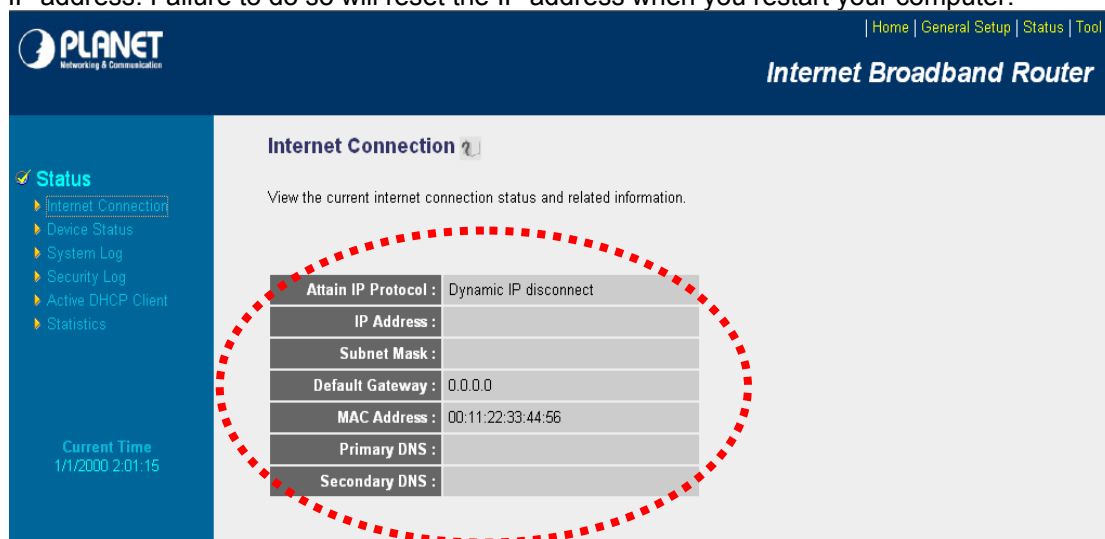

The screenshot shows the 'Internet Connection' status page. A table lists the following information:

Attain IP Protocol :	Dynamic IP disconnect
IP Address :	
Subnet Mask :	
Default Gateway :	0.0.0.0
MAC Address :	00:11:22:33:44:56
Primary DNS :	
Secondary DNS :	

Your WAN IP Address will be listed here.

3. Open/set Virtual Server Ports to enable remote image viewing

The firewall security features built into the router and most routers prevent users from accessing the video from the device over the Internet. The router connects to the Internet over

a series of numbered ports. The ports normally used by the device are blocked from access over the Internet. Therefore, these ports need to be made accessible over the Internet. This is accomplished using the **Virtual Server** function on the router. The Virtual Server ports used by the camera must be opened through the router for remote access to your camera.

Follow these steps to configure your router's Virtual Server settings

- Click **Enabled**.
- Enter a unique name for each entry.
- Select **Both** under **Protocol Type (TCP and UDP)**
- Enter your camera's local IP address (e.g., **192.168.0.100**, for example) in the **Private IP** field.
- If you are using the default camera port settings, enter **80** into the **Public** and **Private Port** section and click **Add**.

A check mark appearing before the entry name will indicate that the ports are enabled.



Some ISPs block access to port 80. Be sure to check with your ISP so that you can open the appropriate ports accordingly. If your ISP does not pass traffic on port 80, you will need to change the port the camera uses from 80 to something else, such as 8080. Not all routers are the same, so refer to your user manual for specific instructions on how to open ports.

Home | General Setup | Status | Tool

Internet Broadband Router

Virtual Server ?

You can configure the Broadband router as a Virtual Server so that remote users accessing services such as the Web or FTP at your local site via Public IP Addresses can be automatically redirected to local servers configured with Private IP Addresses. In other words, depending on the requested service (TCP/UDP) port number, the Broadband router redirects the external service request to the appropriate internal server (located at one of your LAN's Private IP Address).

Enable Virtual Server

Private IP	Private Port	Type	Public Port	WAN Port	Comment
<input type="text"/>	<input type="text"/>	Both	<input type="text"/>	WAN1	<input type="text"/>

Current Virtual Server Table:

Private IP	Private Port	Type	Public Port	WAN Port	Comment	Select
192.168.0.100	80	TCP+UDP	80	WAN1	ICA-HM230	<input type="checkbox"/>

Enter valid ports in the **Virtual Server** section of your router. Please make sure to check the box on this line to enable settings. Then the device can be accessed from WAN by the router's WAN IP address.

By now, you have finished your entire PC configuration for this device.