

## L2+ 46-Port 100/1000BASE-X SFP + 2-Port Gigabit TP/SFP + 4-Port 10G SFP+ Managed Switch

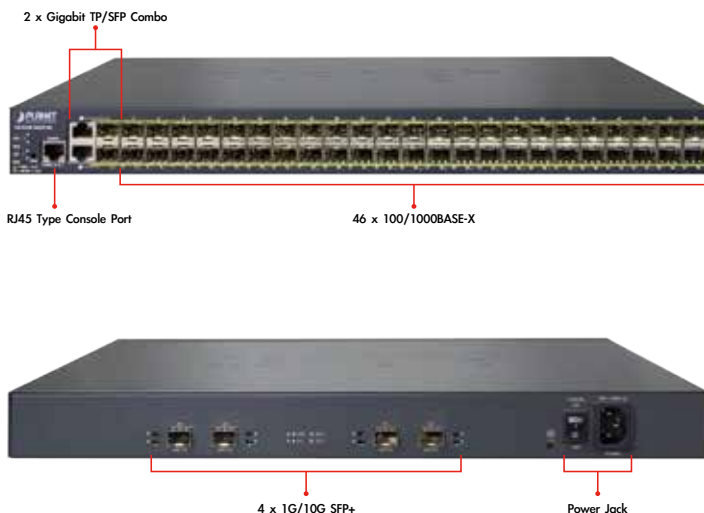

### Ideal Combination of 10G Uplink, High-density, Gigabit and Layer 3 Static Routing

PLANET GS-5220-46S2C4X is a Layer 2+ Managed Gigabit Switch that features 46-port 100/1000BASE-X + 2-port Gigabit TP/SFP Combo + 4-port 10G SFP+ and supports **static Layer 3 routing** in a 1U case. With **10Gbps uplink** capability and total 176Gbps high performance switch architecture, the GS-5220-46S2C4X can handle extremely large amounts of data in a secure topology linking to a data center/service provider backbone or high capacity servers. Each of the SFP+ slots supports **Dual-Speed, 10GBASE-SR/LR or 1000BASE-SX/LX**, meaning the administrator now can flexibly choose the suitable SFP/SFP+ transceiver according to the transmission distance or the transmission speed required to extend the network efficiently.



### Physical Port

- 48 100/1000BASE-X mini-GBIC/SFP slots
- 2 10/100/1000BASE-T RJ45 copper ports, shared with port-1 to port-2
- 4 10GBASE-SR/LR SFP+ slots, compatible with 1000BASE-SX/LX/BX SFP
- RJ45 to RS232 DB9 console interface for basic management and setup

### Layer 2 Features

- Prevents packet loss with back pressure (half-duplex) and IEEE 802.3x pause frame flow control (full-duplex)
- High performance of Store-and-Forward architecture, and runt/CRC filtering eliminates erroneous packets to optimize the network bandwidth
- Storm control support
  - Broadcast / Unicast / Unknown-unicast
- Supports VLAN
  - IEEE 802.1Q tagged VLAN
  - Up to 255 VLANs groups, out of 4095 VLAN IDs
  - Provider Bridging (VLAN Q-in-Q) support (IEEE 802.1ad)
  - Private VLAN Edge (PVE)
  - Protocol-based VLAN
  - MAC-based VLAN
  - IP Subnet-based VLAN
  - Voice VLAN
- Supports Spanning Tree Protocol
  - STP, IEEE 802.1D Spanning Tree Protocol
  - RSTP, IEEE 802.1w Rapid Spanning Tree Protocol
  - MSTP, IEEE 802.1s Multiple Spanning Tree Protocol, spanning tree by VLAN
  - BPDU Guard
- Supports Link Aggregation
  - 802.3ad Link Aggregation Control Protocol (LACP)
  - Cisco ether-channel (Static Trunk)
  - Maximum 26 trunk groups, up to 8 ports per trunk group
  - Up to 16Gbps bandwidth (full duplex mode)
- Provides port mirror (many-to-1)
- Port mirroring to monitor the incoming or outgoing traffic on a particular port
- Loop protection to avoid broadcast loops

**High-level IPTV Application with MVR (Multicast VLAN Registration) Solution**

High-level IPTV application is designed for using wide-scale deployment of multicast traffic across a service provider network. It's important to reduce the redundant bandwidth of IPTV stream in the higher bandwidth required network. MVR allows a subscriber on a port to subscribe and unsubscribe to a multicast stream on the network-wide multicast VLAN. It enables the single multicast VLAN to be shared in the network while subscribers remain in separate VLANs. MVR provides the ability to continuously send multicast streams in the multicast VLAN, but to isolate the streams from the subscriber VLANs for bandwidth and security reasons.

**Reducing IPTV Stream Bandwidth with MVR Solution**

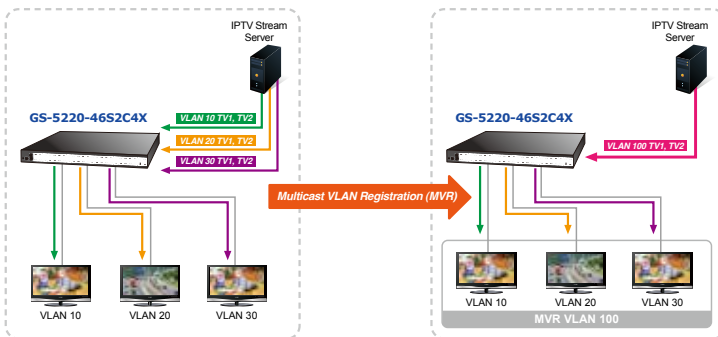

**Intelligent SFP Diagnosis Mechanism**

The GS-5220-46S2C4X supports SFP-DDM (Digital Diagnostic Monitor) function that greatly helps network administrator to easily monitor real-time parameters of the SFP, such as optical output power, optical input power, temperature, laser bias current, and transceiver supply voltage.

**Digital Diagnostic Monitor (DDM)**

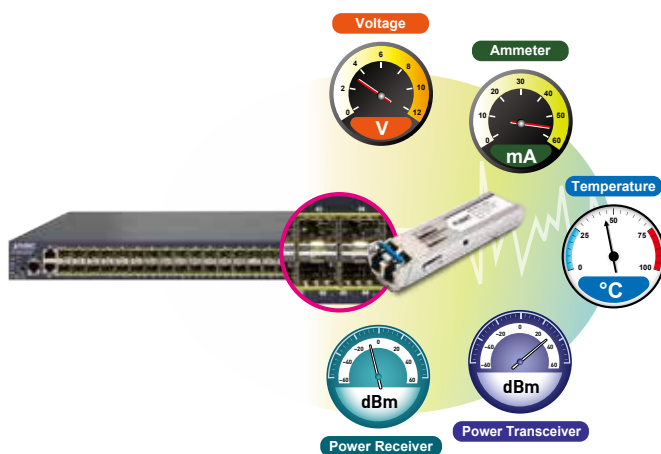

**IPv6 / IPv4 Dual Stack**

Supporting both IPv6 and IPv4 protocols, the GS-5220-46S2C4X helps the data center/service provider to experience the IPv6 era with the lowest investment as its network facilities need not to be replaced or overhauled if the IPv6 FTTx edge network is set up.

**Layer 3 IP Routing Features**

- Supports maximum 32 static routes and route summarization

**Quality of Service**

- Ingress shaper and egress rate limit per port bandwidth control
- 8 priority queues on all switch ports
- Traffic classification
  - IEEE 802.1p CoS
  - ToS / DSCP / IP Precedence of IPv4/IPv6 packets
  - IP TCP/UDP port number
  - Typical network application
- Strict priority and Weighted Round Robin (WRR) CoS policies
- Traffic-policing policies on the switch port
- DSCP remarking

**Multicast**

- Supports IGMP snooping v1, v2 and v3
- Supports MLD snooping v1 and v2
- Querier mode support
- IGMP snooping port filtering
- MLD snooping port filtering
- MVR (Multicast VLAN Registration)

**Security**

- Authentication
  - IEEE 802.1x port-based / MAC-based network access authentication
  - IEEE 802.1x authentication with guest VLAN
  - Built-in RADIUS client to cooperate with the RADIUS servers
  - RADIUS / TACACS+ users access authentication
- Access Control List
  - IP-based Access Control List (ACL)
  - MAC-based Access Control List (ACL)
- Source MAC / IP address binding
- DHCP Snooping to filter distrusted DHCP messages
- Dynamic ARP Inspection discards ARP packets with invalid MAC address to IP address binding
- IP Source Guard prevents IP spoofing attacks
- IP address access management to prevent unauthorized intruder

### Layer 3 IPv4 and IPv6 VLAN Routing for Secure and Flexible Management

The GS-5220-46S2C4X not only provides ultra high transmission performance, and excellent layer 2 and layer 4 technologies, but also layer 3 IPv4/IPv6 VLAN routing feature which allows to cross over different VLANs and different IP addresses for the purpose of having a highly-secured, flexible management and simpler networking application.

### Robust Layer 2 Features

The GS-5220-46S2C4X can be programmed for advanced switch management functions such as dynamic port link aggregation, **Q-in-Q VLAN**, private VLAN, **Multiple Spanning Tree protocol (MSTP)**, Layer 2 to Layer 4 QoS, bandwidth control and **IGMP/MLD Snooping**. Via the link aggregation of supporting ports, the GS-5220-46S2C4X allows the operation of a high-speed trunk to combine with multiple fiber ports and supports fail-over as well.

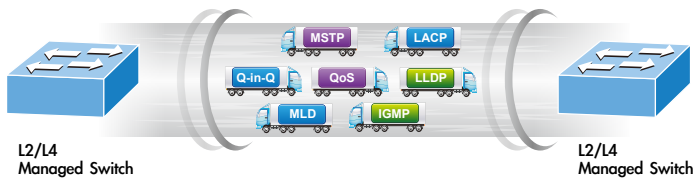

### Powerful Security

The GS-5220-46S2C4X offers a comprehensive layer 2 to layer 4 Access Control List (ACL) for enforcing security to the edge. It can be used to restrict network access by denying packets based on source and destination IP address, TCP/UDP ports or defined typical network applications. Its protection mechanism also comprises 802.1X Port-based and MAC-based user and device authentication. With the private VLAN function, communication between edge ports can be prevented to ensure user privacy. The GS-5220-46S2C4X also provides DHCP Snooping, IP Source Guard and Dynamic ARP Inspection functions to prevent IP snooping from attack and discard ARP packets with invalid MAC address. The network administrators can now construct highly-secured corporate networks with considerably less time and effort than before.

### Excellent Traffic Control

The GS-5220-46S2C4X is loaded with powerful traffic management and QoS features to enhance connection services by service provider. The QoS features include wire-speed Layer 4 traffic classifiers and bandwidth limit that are particularly useful for multi-tenant unit, multi business unit, Telco, or network service provider's applications. It also empowers the enterprises to take full advantage of the limited network resources and guarantees the best performance in VoIP and video conferencing transmission.

### Efficient and Secure Management

The GS-5220-46S2C4X Managed Switch is equipped with console, Web and SNMP management interfaces. The GS-5220-46S2C4X supports standard Simple Network Management Protocol (SNMP) and can be managed via any management software based on standard of SNMP protocol. For reducing product learning time, the GS-5220-46S2C4X offers Cisco-like command via Telnet or console port and customer doesn't need to learn new command from these switches. Moreover, the GS-5220-46S2C4X offers secure remote management by supporting SSH, SSL and SNMPv3 connections which encrypt the packet content at each session.

### Management

- IPv4 and IPv6 dual stack management
- Switch Management Interfaces
  - Console / Telnet command line interface
  - Web switch management
  - SNMP v1, v2c, and v3 switch management
  - SSH / SSL secure access
- IPv6 Address / NTP management
- Built-in Trivial File Transfer Protocol (TFTP) client
- BOOTP and DHCP for IP address assignment
- System Maintenance
  - Firmware upload / download via HTTP / TFTP
  - Reset button for system reboot or reset to factory default
  - Dual images
- DHCP relay and option 82
- User privilege levels control
- NTP (Network Time Protocol)
- Link Layer Discovery Protocol (LLDP) and LLDP-MED
- Network diagnostic
  - SFP-DDM (Digital Diagnostic Monitor)
  - Cable diagnostic technology provides the mechanism to detect and report potential cabling issues
  - ICMPv6 / ICMPv4 remote ping
- SMTP / Syslog remote alarm
- Four RMON groups (history, statistics, alarms and events)
- SNMP trap for interface link up and link down notification
- System Log
- PLANET Smart Discovery Utility for deploy management

*Flexibility and Extension Solution*

The 48 mini-GBIC slots built in the GS-5220-46S2C4X support dual speed as it features 100BASE-FX and 1000BASE-SX/LX SFP (Small Form-factor Pluggable) fiber-optic modules. Now the administrator can flexibly choose the suitable SFP transceiver according to not only the transmission distance, but also the transmission speed required. The distance can be extended from 550 meters to 2km (multi-mode fiber) up to above 10/20/30/40/50/70/120 kilometers (single-mode fiber or WDM fiber). They are well suited for applications within the enterprise data centers and distributions.

## Applications

*Highly Available Mesh Networking Solution for Big Data System*

By means of improving the technology of Optical Fiber Ethernet with highly-flexible, highly-extendable and easy-to-install features, the GS-5220-46S2C4X offers up to 176Gbps data exchange speed via Optical Fiber interface and the transmission distance can be extended to 10km. The GS-5220-46S2C4X features strong rapid self-recovery capability to prevent interruptions and external intrusions. It incorporates **Multiple Spanning Tree Protocol (802.1s MSTP)** into customer's automation network to enhance system reliability and uptime. The GS-5220-46S2C4X is the ideal **Big Data** solution for data centers, service providers and telecoms to build redundant connection and establish high bandwidth for server farm.

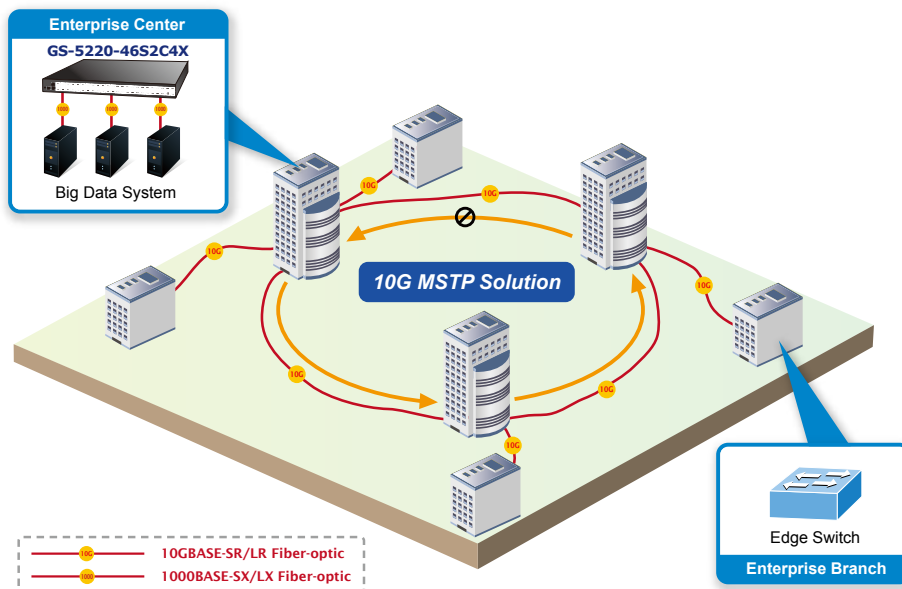

*Triple Play Service of Backbone Network Solution*

In telecommunications, triple play service is a marketing term for the provisioning, over a single broadband connection of more bandwidth-intensive services, such as broadband Internet access and television, and the latency-sensitive telephone. The GS-5220-46S2C2X offers up to **176Gbps** bandwidth to exchange data, voice, video packets via fiber patch cable. It's the suitable aggregation switch for ISP and Telco in the heavy traffic backbone network.

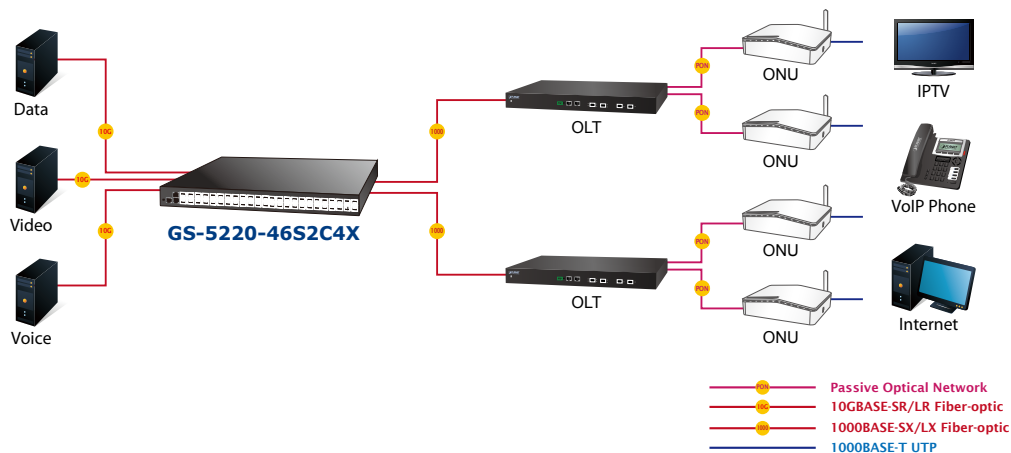

*Layer 2+ VLAN Static Routing and 10G Uplink Application*

With the built-in robust IPv4 / IPv6 Layer 3 traffic routing protocols, the GS-5220-46S2C4X ensures reliable routing between VLANs and network segments. The routing protocols can be applied by VLAN interface with up to 128 routing entries. The GS-5220-46S2C4X is certainly a cost-effective and ideal solution for enterprises.

### VLAN Routing + 10G Uplink Applications

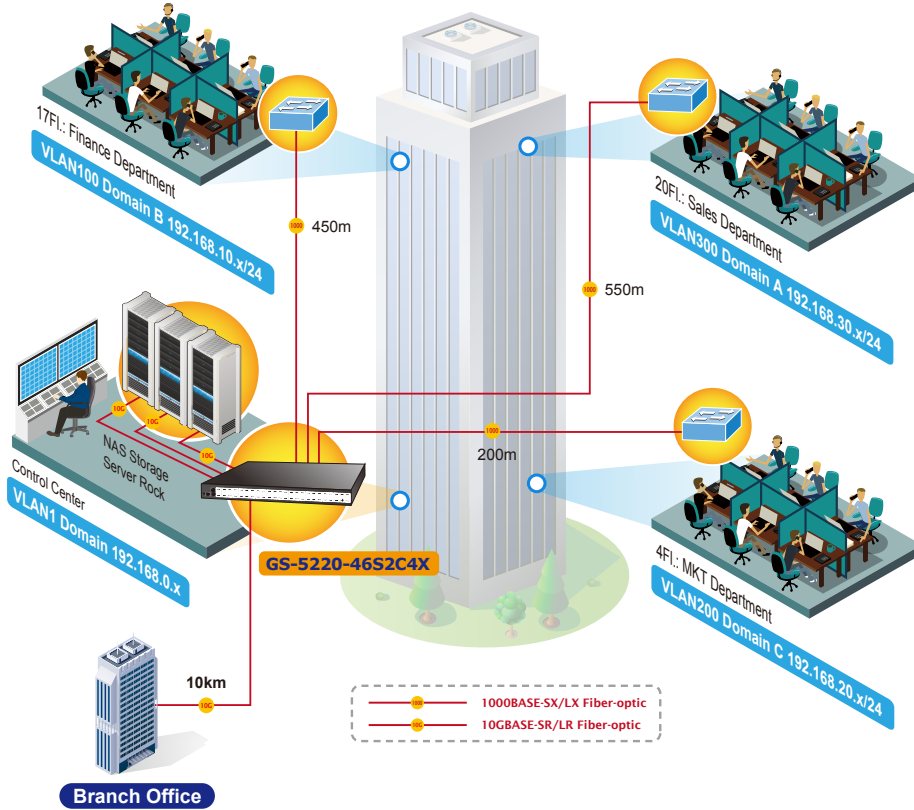

## Specifications

|                                     |   |
|-------------------------------------|---|
| Product                             | GS-5220-46S2C4X   |
| <b>Hardware Specifications</b>      |   |
| Copper Ports                        | 2 10/100/1000BASE-T RJ45 auto-MDI/MDI-X ports, shared with Port-1 to Port-2   |
| SFP/mini-GBIC Slots                 | 48 100/1000BASE-X SFP interfaces<br>Compatible with 100BASE-FX SFP transceiver  |
| SFP+ Slots                          | 4 10GBASE-SR/LR SFP+ interface (Port-49 to Port-52)<br>Compatible with 1000BASE-SX/LX/BX SFP transceiver  |
| Console                             | 1 x RS-232-to-RJ45 serial port (115200, 8, N, 1)  |
| Switch Architecture                 | Store-and-Forward   |
| Switch Fabric                       | 176Gbps   |
| Throughput                          | 130.95Mpps@64Bytes  |
| Address Table                       | 32K entries, automatic source address learning and ageing   |
| Shared Data Buffer                  | 32M bits  |
| Flow Control                        | IEEE 802.3x pause frame for full-duplex<br>Back pressure for half-duplex  |
| Jumbo Frame                         | 10K bytes   |
| Reset Button                        | < 5 sec: System reboot<br>> 5 sec: Factory default  |
| Dimensions (W x D x H)              | 440 x 300 x 44.5 mm, 1U height  |
| Weight                              | 4346g   |
| LED                                 | System:<br>PWR (Green), SYS (Green), Fan 1 (Red), Fan 2 (Red)<br>10/100/1000T RJ45 Combo Interfaces (Port 1 to Port 2):<br>1000Mbps LNK/ACT (Green)<br>10/100Mbps LNK/ACT (Orange)<br>100/1000Mbps SFP Interfaces (Port 1 to Port 48):<br>1000Mbps LNK/ACT (Green)<br>100Mbps LNK/ACT (Orange)<br>1/10Gbps SFP+ Interfaces (Port 49 to Port 52):<br>10G (Green)<br>1G (Green) |
| Power Requirements                  | 100~240V AC, 50/60Hz  |
| Power Consumption                   | 80 watts / 272.9 BTU/hr (max.)  |
| ESD Protection                      | Air discharge: ± 8kV<br>Contact discharge: ± 4kV  |
| <b>Layer 2 Management Functions</b> |   |
| Port Configuration                  | Port disable / enable<br>Auto-negotiation 10/100/1000Mbps full and half duplex mode selection<br>Flow control disable / enable  |
| Port Status                         | Display each port's speed duplex mode, link status, flow control status, auto-negotiation status, trunk status  |
| Port Mirroring                      | TX / RX / Both<br>Many-to-1 monitor   |
| VLAN                                | 802.1Q tagged based VLAN<br>Q-in-Q tunneling<br>Private VLAN Edge (PVE)<br>MAC-based VLAN<br>Protocol-based VLAN<br>Voice VLAN<br>IP Subnet-based VLAN<br>MVR (Multicast VLAN Registration)<br>Up to 255 VLAN groups, out of 4095 VLAN IDs  |
| Link Aggregation                    | IEEE 802.3ad LACP / Static Trunk<br>26 groups of 8-Port trunk supported   |
| Spanning Tree Protocol              | STP, IEEE 802.1D Spanning Tree Protocol<br>RSTP, IEEE 802.1w Rapid Spanning Tree Protocol<br>MSTP, IEEE 802.1s Multiple Spanning Tree Protocol  |
| QoS                                 | Traffic classification based, Strict priority and WRR<br>8-level priority for switching<br>- Port Number<br>- 802.1p priority<br>- 802.1Q VLAN tag<br>- DSCP/ToS field in IP packet   |

|                              |   |   |
|------------------------------|---|---|
| IGMP Snooping                | IGMP (v1 / v2 / v3) Snooping, up to 255 multicast groups<br>IGMP Querier mode support   |   |
| MLD Snooping                 | MLD (v1 / v2) Snooping, up to 255 multicast groups<br>MLD Querier mode support  |   |
| Access Control List          | IP-based ACL / MAC-based ACL<br>Up to 256 entries   |   |
| Bandwidth Control            | Per port bandwidth control<br>Ingress: 100Kbps~1000Mbps<br>Egress: 100Kbps~1000Mbps   |   |
| <b>Layer 3 Functions</b>     |   |   |
| IP Interfaces                | Max. 128 VLAN interfaces  |   |
| Routing Table                | Max. 32 routing entries   |   |
| Routing Protocols            | IPv4 hardware Static Routing<br>IPv6 hardware Static Routing  |   |
| <b>Management</b>            |   |   |
| Basic Management Interfaces  | Console / Telnet / Web browser / SNMP v1, v2c   |   |
| Secure Management Interfaces | SSH, SSL, SNMP v3   |   |
| SNMP MIBs                    | RFC 1213 MIB-II<br>RFC 1493 Bridge MIB<br>RFC 1643 Ethernet MIB<br>RFC 2863 Interface MIB<br>RFC 2665 Ether-Like MIB<br>RFC 2819 RMON MIB (Group 1, 2, 3 and 9)<br>RFC 2737 Entity MIB<br>RFC 2618 RADIUS Client MIB  | RFC 2863 IF-MIB<br>RFC 2933 IGMP-STD-MIB<br>RFC 3411 SNMP-Frameworks-MIB<br>RFC 4292 IP Forward MIB<br>RFC 4293 IP MIB<br>RFC 4836 MAU-MIB<br>IEEE 802.1X PAE<br>LLDP   |
| <b>Standards Conformance</b> |   |   |
| Regulation Compliance        | FCC Part 15 Class A, CE   |   |
| Standards Compliance         | IEEE 802.3 10BASE-T<br>IEEE 802.3u 100BASE-TX/100BASE-FX<br>IEEE 802.3z Gigabit SX/LX<br>IEEE 802.3ab Gigabit 1000T<br>IEEE 802.3ae 10Gb/s Ethernet<br>IEEE 802.3x flow control and back pressure<br>IEEE 802.3ad port trunk with LACP<br>IEEE 802.1D Spanning Tree Protocol<br>IEEE 802.1w Rapid Spanning Tree Protocol<br>IEEE 802.1s Multiple Spanning Tree Protocol<br>IEEE 802.1p Class of Service<br>IEEE 802.1Q VLAN tagging | IEEE 802.1X Port Authentication Network Control<br>IEEE 802.1ab LLDP<br>RFC 768 UDP<br>RFC 793 TFTP<br>RFC 791 IP<br>RFC 792 ICMP<br>RFC 2068 HTTP<br>RFC 1112 IGMP version 1<br>RFC 2236 IGMP version 2<br>RFC 3376 IGMP version 3<br>RFC 2710 MLD version 1<br>RFC 3810 MLD version 2 |
| <b>Environment</b>           |   |   |
| Operating                    | Temperature: 0 ~ 50 degrees C<br>Relative Humidity: 5 ~ 95% (non-condensing)  |   |
| Storage                      | Temperature: -10 ~ 70 degrees C<br>Relative Humidity: 5 ~ 95% (non-condensing)  |   |

## Ordering Information

|                 |   |
|-----------------|---|
| GS-5220-46S2C4X | L2+ 46-Port 100/1000BASE-X SFP + 2-Port Gigabit TP/SFP + 4-Port 10G SFP+ Managed Switch with Hardware Layer3 IPv4/IPv6 Static Routing |
|-----------------|---|

## Related Products

|                                |   |
|--------------------------------|---|
| GS-5220-44S4C                  | L2+ 44-Port 100/1000BASE-X + 4-Port Gigabit TP/SFP Managed Switch with Hardware Layer3 IPv4/IPv6 Static Routing                 |
| GS-5220-48T4X                  | L2+ 44-Port 10/100/1000T + 4-Port Gigabit TP/SFP + 4-Port 10G SFP+ Managed Switch with Hardware Layer3 IPv4/IPv6 Static Routing |
| GS-5220-16S8C / GS-5220-16S8CR | L2+ 24-Port 100/1000X SFP + 8-Port Shared TP Managed Switch   |
| MGSW-28240F                    | 24-Port 100/1000BASE-X SFP with 4-Port 10G SFP+ L2/L4 Managed Metro Ethernet Switch   |
| EPL-2000                       | 2-PON-Port GEAPON OLT with Uplink 2 1000BASE-X SFP Slots  |
| XDL-2420R                      | 24-Port VDSL2 / ADSL2+ with 2-Port Gigabit TP/SFP Combo IP DSLAM  |

## Available Modules for GS-5220-46S2C4X

|                 |  |
|-----------------|--|
| MTB-SR          | SFP+ Port 10GBASE-SR mini-GBIC Module (Multi-mode / 850nm / max. 300m)   |
| MTB-LR          | SFP+ Port 10GBASE-LR mini-GBIC Module (Single mode / 1310nm / max. 10km) |
| CB-DASFP-0.5/2M | 10G SFP+ Directly-Attached Copper Cable (0.5/2M in length)               |
| MGB-GT          | SFP-Port 1000BASE-T Module   |
| MGB-SX          | SFP-Port 1000BASE-SX mini-GBIC Module                                    |
| MGB-LX          | SFP-Port 1000BASE-LX mini-GBIC Module                                    |
| MGB-L30         | SFP-Port 1000 BASE-LX mini-GBIC Module - 30km                            |
| MGB-L50         | SFP-Port 1000 BASE-LX mini-GBIC Module - 50km                            |
| MGB-L70         | SFP-Port 1000 BASE-LX mini-GBIC Module - 70km                            |
| MGB-L120        | SFP-Port 1000BASE-LX mini-GBIC Module - 120km                            |
| MGB-LA10        | SFP-Port 1000BASE-LX (WDM,TX:1310nm) mini-GBIC Module - 10km             |
| MGB-LB10        | SFP-Port 1000BASE-LX (WDM,TX:1550nm) mini-GBIC Module - 10km             |
| MGB-LA20        | SFP-Port 1000BASE-LX (WDM,TX:1310nm) mini-GBIC Module - 20km             |
| MGB-LB20        | SFP-Port 1000BASE-LX (WDM,TX:1550nm) mini-GBIC Module - 20km             |
| MGB-LA40        | SFP-Port 1000BASE-LX (WDM,TX:1310nm) mini-GBIC Module - 40km             |
| MGB-LB40        | SFP-Port 1000BASE-LX (WDM,TX:1550nm) mini-GBIC Module - 40km             |
| MGB-TSX         | SFP-Port 1000BASE-SX mini-GBIC Module - 550m (-40~75 degrees C)          |
| MGB-TLX         | SFP-Port 1000BASE-LX mini-GBIC Module - 10km (-40~75 degrees C)          |
| MGB-TL30        | SFP-Port 1000BASE-LX mini-GBIC Module - 30km (-40~75 degrees C)          |
| MGB-TL70        | SFP-Port 1000BASE-LX mini-GBIC Module - 70km (-40~75 degrees C)          |
| MFB-FX          | SFP-Port 100BASE-FX Transceiver (1310nm) - 2km                           |
| MFB-F20         | SFP-Port 100BASE-FX Transceiver (1310nm) - 20km                          |
| MFB-F40         | SFP-Port 100BASE-FX Transceiver (1310nm) - 40km                          |
| MFB-F60         | SFP-Port 100BASE-FX Transceiver (1310nm) - 60km                          |
| MFB-FA20        | SFP-Port 100BASE-BX Transceiver (WDM,TX:1310nm) - 20km                   |
| MFB-FB20        | SFP-Port 100BASE-BX Transceiver (WDM,TX:1550nm) - 20km                   |