

**L2+ 24-Port 10/100/1000Mbps 802.3at PoE  
+ 4-Port 10G SFP+ Managed Switch with  
Hardware Layer3 IPv4/IPv6 Static Routing**

**XGSW-28040HP**

Quick Installation Guide

# Table of Contents

1. Package Contents .....	3
2. Requirements .....	4
3. Terminal Setup .....	5
4. Logon to Console.....	6
5. Configuring IP Address.....	7
6. Starting Web Management .....	9
7. Saving Configuration .....	12
8. Recovering Back to Default Configuration.....	13
9. Customer Support .....	14

---

## 1. Package Contents

Thank you for purchasing PLANET L2+ 24-Port 10/100/1000Mbps 802.3at PoE + 4-Port 10G SFP+ Managed Switch with Hardware Layer3 IPv4/IPv6 Static Routing, XGSW-28040HP. **"Managed Switch"** mentioned in this Guide refers to the XGSW-28040HP.

Open the box of the Managed Switch and carefully unpack it. The box should contain the following items:

- The XGSW-28040HP Managed Switch x 1
- User's Manual CD x 1
- Quick Installation Guide x 1
- RJ-45 to RS232 Cable x 1
- Rubber Feet x 4
- Two Rack-mounting Brackets with Attachment Screws x 1
- Power Cord x 1
- SFP Dust Cap x 8
- If any item is found missing or damaged, please contact your local reseller for replacement.

## 2. Requirements

- Workstations running Windows XP/2003/Vista/7/8/2008, MAC OS X or later, Linux, UNIX, or other platforms are compatible with TCP/IP protocols.
- Workstations are installed with Ethernet NIC (Network Interface Card)
- **Serial Port Connection** (Terminal)
  - ◆ The above Workstations come with COM Port (DB9) or USB-to-RS-232 converter.
  - ◆ The above Workstations have been installed with terminal emulator, such as Hyper Terminal included in Windows XP/2003.
  - ◆ Serial cable -- one end is attached to the RS-232 serial port, while the other end to the console port of the Managed Switch.
- **Ethernet Port Connection**
  - ◆ Network cables -- Use standard network (UTP) cables with RJ-45 connectors.
  - ◆ The above PC is installed with Web Browser and JAVA runtime environment plug-in.



### Note

It is recommended to use Internet Explore 8.0 or above to access the Managed Switch. If the Web interface of the Managed Switch is not accessible, please turn off the anti-virus software or firewall and then try it again.

### 3. Terminal Setup

To configure the system, connect a serial cable to a **COM port** on a PC or notebook computer and to RJ-45 type of serial (console) port of the Managed Switch.

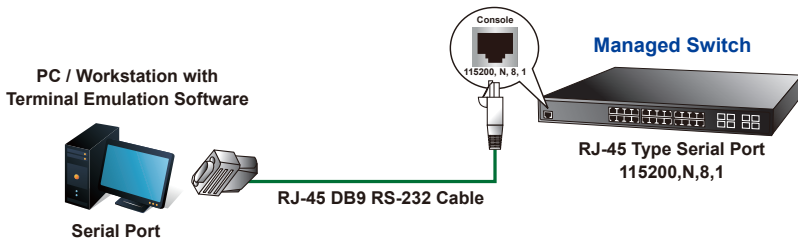

Figure 3-1: Managed Switch Console Connectivity

A terminal program is required to make the software connection to the Managed Switch. Windows' **Hyper Terminal** program may be a good choice. The Hyper Terminal can be accessed from the Start menu.

1. Click **START**, then **Programs, Accessories** and then **Hyper Terminal**.
2. When the following screen appears, make sure that the COM port should be configured as:

- ◆ Baud : 115200
- ◆ Data bits : 8
- ◆ Parity : None
- ◆ Stop bits : 1
- ◆ Flow control : None

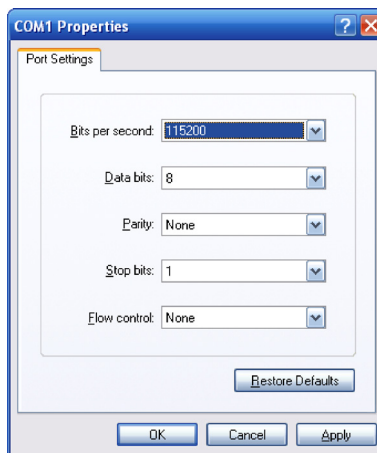

Figure 3-2 Hyper Terminal COM Port Configuration

## 4. Logon to Console

Once the terminal is connected to the device, power on the Managed Switch, and the terminal will display "running testing procedures". Then, the following message asks to log-in user name and password. The factory default user name and password are shown as follows and the login screen in Figure 4-1 appears.

```
Username: admin
Password: admin
```

```
+RAM: 0x80000000-0x88000000 [0x800214a8-0x87fe0000 available]
FLASH: 0x40000000-0x40ffffff, 256 x 0x10000 blocks
== Executing boot script in 3.000 seconds - enter ^C to abort
> fis load -d managed
Image loaded from 0x80040000-0x80bdf644
> go

Press ENTER to get started

Username: admin
Password:
XGSW-26040HP# █
```

Figure 4-1: Managed Switch Console Login Screen

The user can now enter commands to manage the Managed Switch. For a detailed description of the commands, please refer to the following chapters.



Note

1. For security reason, please change and memorize the new password after this first setup.
2. Only accept command in lowercase letter under console interface.

## 5. Configuring IP Address

The Managed Switch is shipped with default IP address shown below.

```
IP Address: 192.168.0.100  
Subnet Mask: 255.255.255.0
```

To check the current IP address or modify a new IP address for the Switch, please use the procedures as follows:

### ■ Show the current IP Address

1. At the “#” prompt, enter “**show ip interface brief**”.
2. The screen displays the current IP address as shown in Figure 5-1.

```
Press ENTER to get started:RAM: 0x80000000-0x88000000 [0x800214a8-0x87fe0000 available]
FLASH: 0x40000000-0x40ffffff 256 x 0x10000 blocks
== Executing boot script in 3.000 seconds - enter ^C to abort
> fis load -d managed
Image loaded from 0x80040000-0x80bdf644
> go
Press ENTER to get started
Username: admin
Password:
XGSW-28040HP# show ip interface brief
Vlan Address Method Status
-----
1 192.168.0.100/24 Manual DOWN
XGSW-28040HP#
```

Figure 5-1: IP Information Screen

### ■ Configuring IP Address

3. At the “#” prompt, enter the following command and press **<Enter>** as shown in Figure 5-2.

```
XGSW-28040HP# configure terminal  
XGSW-28040HP(config)# interface vlan 1  
XGSW-28040HP(config-if-vlan)# ip address 192.168.1.100 255.255.255.
```

The previous command would apply the following settings for the Managed Switch.

```
IP Address: 192.168.1.100  
Subnet Mask: 255.255.255.0
```

```
Press ENTER to get started
Username: admin
Password:
XGSW-28040HP# configure terminal
XGSW-28040HP(config)# interface vlan 1
XGSW-28040HP(config-if-vlan)# ip address 192.168.1.100 255.255.255.0
XGSW-28040HP(config-if-vlan)#
```

Figure 5-2: Configuring IP Address Screen

4. Repeat step 1 to check if the IP address is changed.

## ■ Store current switch configuration

5. At the “#” prompt, enter the following command and press <Enter>.

```
# copy running-config startup-config
```

```
Press ENTER to get started
Username: admin
Password:
XGSW-28040HP# configure terminal
XGSW-28040HP(config)# interface vlan 1
XGSW-28040HP(config-if-vlan)# ip address 192.168.1.100 255.255.255.0
XGSW-28040HP(config-if-vlan)#
XGSW-28040HP(config-if-vlan)#
XGSW-28040HP(config-if-vlan)# exit
XGSW-28040HP(config)# exit
XGSW-28040HP#
XGSW-28040HP#
XGSW-28040HP#
XGSW-28040HP# copy running-config startup-config
Building configuration...
✓ Saving 2199 bytes to flash:startup-config
XGSW-28040HP# █
```

**Figure 5-3:** Saving Current Configuration Command Screen

If the IP is successfully configured, the Managed Switch will apply the new IP address setting immediately. You can access the Web interface of the Managed Switch through the new IP address.



Note

If you are not familiar with the console command or the related parameter, enter “**help**” anytime in console to get the help description.



## 6. Starting Web Management

The following shows how to start up the **Web Management** of the Managed Switch. Note the Managed Switch is configured through an Ethernet connection. Please make sure the manager PC must be set on the same **IP subnet address**.

For example, the default IP address of the Managed Switch is **192.168.0.100**, then the manager PC should be set at **192.168.0.x** (where x is a number between 1 and 254, except 100), and the default subnet mask is 255.255.255.0.

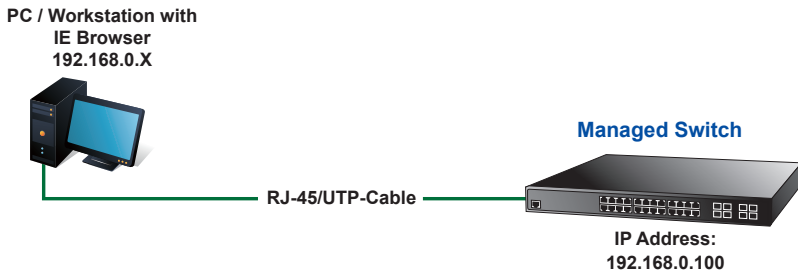

Figure 6-1: IP Management Diagram

## Logging in the Managed Switch

1. Use Internet Explorer 8.0 or above Web browser and enter IP address **http://192.168.0.100** (the factory default IP address or the one that you have just changed in console) to access the Web interface.
2. When the following dialog box appears, please enter the default user name and password **"admin"** (or the password you have changed via console). The login screen in Figure 6-2 appears.

Default Username: **admin**  
Default Password: **admin**



Figure 6-2: Login Screen

3. After entering the password, the main screen appears as Figure 6-3 shows.

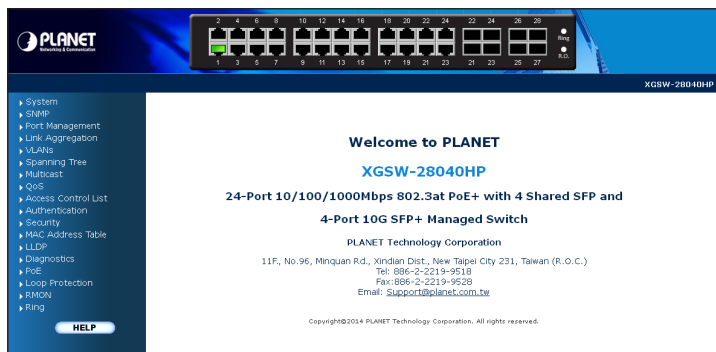
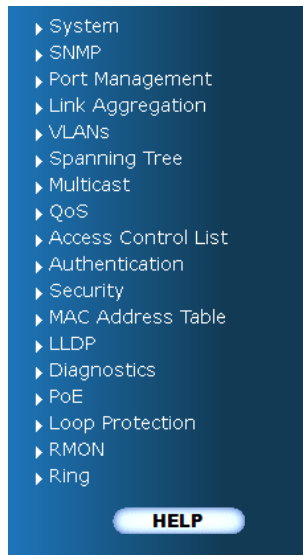

Figure 6-3: Web Main Screen of Managed Switch

The Switch Menu on the left of the Web page let you access all the commands and statistics the Managed Switch provides.



**Figure 6-4:** Switch Menu



**Note**

If you are not familiar with Switch functions or the related parameter, press **"Help icon"** anytime on the Web page to get the help description.

Now, you can use the Web management interface to continue the Switch management or manage the Switch by console interface.

Please refer to the user's manual for more.

## 7. Saving Configuration

In the Managed Switch, the running configuration file stores in the RAM. In the current version, the running configuration sequence of running-config can be saved from the RAM to FLASH by executing save startup config command, so that the running configuration sequence becomes the startup configuration file, which is called configuration save.

To save all applied changes and set the current configuration as a startup configuration. The startup-configuration file will be loaded automatically across a system reboot.

1. Click System, Save Startup Config.

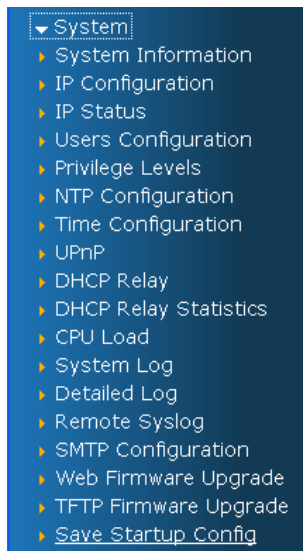

2. Press the **"Save Configuration"** button.

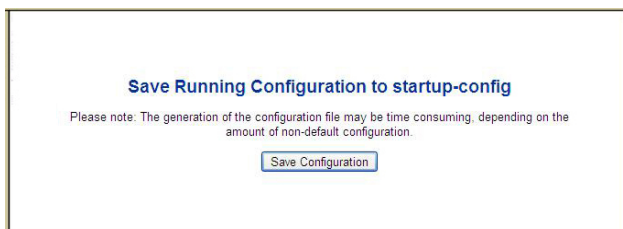

## 8. Recovering Back to Default Configuration

### ■ IP Address has been changed or admin password has been forgotten –

To reset the IP address to the default IP Address “192.168.0.100” or reset the login password to default value, press the hardware **reset button** on the front panel for about **10 seconds**. After the device is rebooted, you can login the management WEB interface within the same subnet of 192.168.0.xx.

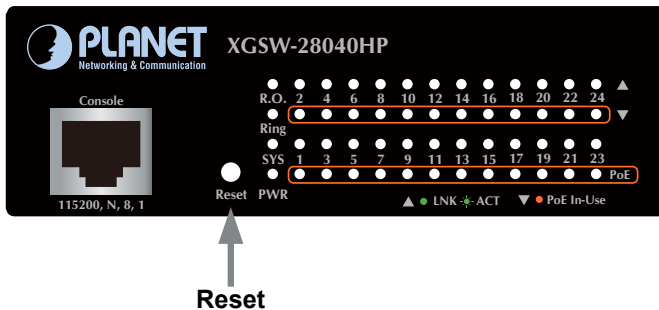

Figure 8-1: XGSW-28040HP Reset Button

---

## **9. Customer Support**

Thank you for purchasing PLANET products. You can browse our online FAQ resource on PLANET Web site first to check if it could solve your issue. If you need more support information, please contact PLANET switch support team.

PLANET online FAQ :

<http://www.planet.com.tw/en/support/faq.php?type=1>

Switch support team mail address :

[support\\_switch@planet.com.tw](mailto:support_switch@planet.com.tw)

Copyright © PLANET Technology Corp. 2014.

Contents are subject to revision without prior notice.

PLANET is a registered trademark of PLANET Technology Corp. All other trademarks belong to their respective owners.

This page is intentionally left blank

This page is intentionally left blank