

**Industrial L2+ Multi-Port Full Gigabit  
Managed Ethernet Switch**

**IGS-10020MT / IGS-10020PT/HPT / IGS-10080MFT  
IGS-12040MT / IGS-20040MT / IGS-20160HPT**

Quick Installation Guide

# Table of Contents

1. Package Contents .....	3
2. Requirements .....	5
3. Wiring the Power Inputs.....	6
4. Terminal Setup .....	10
5. Logon to the Console .....	11
6. Configuring IP address .....	12
7. Starting Web Management .....	15
8. Resetting the Switch to Default .....	17
9. Customer Support .....	20

## 1. Package Contents

Thank you for purchasing PLANET L2+ Industrial Managed Switch, IGS-10020 Series / IGS-10080MFT / IGS-12040MT / IGS-20040MT / IGS-20160HPT. The descriptions of these models are as follows:

IGS-10020MT :	Industrial 8-Port 10/100/1000T + 2-Port 100/1000X SFP Managed Switch
IGS-10020PT :	Industrial 8-Port 10/100/1000T 802.3af PoE + 2-Port 100/1000X SFP Managed Switch
IGS-10020HPT :	Industrial 8-Port 10/100/1000T 802.3af/at PoE + 2-Port 100/1000X SFP Managed Switch
IGS-10080MFT :	Industrial 8-Port 100/1000X SFP + 2-Port 10/100/1000T Managed Switch
IGS-12040MT :	Industrial 8-Port 10/100/1000T + 4-Port 100/1000X SFP Managed Switch
IGS-20040MT :	Industrial 16-Port 10/100/1000T + 4-Port 100/1000X SFP Managed Switch
IGS-20160HPT :	Industrial 16-Port 10/100/1000T 802.3at PoE + 2-Port 10/100/100T + 2-Port 100/1000X SFP Managed Switch

“**Industrial Managed Switch**” mentioned in this Quick Installation Guide refers to the above seven models.

Open the box of the **Industrial Managed Switch** and carefully unpack it. The box should contain the following items:

- The Industrial Managed Switch x 1
- Quick Installation Guide x 1
- DIN Rail Kit x 1
- Wall Mounting Kit x 1
- DB9 to RJ45 Interface RS232 Console Cable x 1  
(Only IGS-10020MT doesn't have console interface)
- Dust Cap (Please refer to the table below)

	<b>RJ45 Dust Cap</b>	<b>SFP Dust Cap</b>
IGS-10020MT	8	2
IGS-10020PT	9	2
IGS-10020HPT	9	2
IGS-10080MFT	3	8
IGS-12040MT	9	4
IGS-20040MT	17	4
IGS-20160HPT	19	2

If any of these are missing or damaged, please contact your dealer immediately. If possible, retain the carton including the original packing materials to enable you to repack the product in case there is a need to return it to us for repair.

---

## 2. Requirements

The Industrial Managed Switch provides remote login interface for management purposes. The following equipment is necessary for further management:

- **Workstation** is installed with Ethernet NIC (Network Interface Card)
- Choice of Internet browsers includes Windows XP/2003, Vista, Windows 7, Windows 8, MAC OS X, Linux, Fedora, Ubuntu or other platforms compatible with TCP/IP protocols.
  - The above workstation is installed with Web browser and JAVA runtime environment plug-in.
- **Ethernet Port** connection
  - Use standard network (UTP) cables with RJ45 connectors.



Note

It is recommended to use Internet Explore 7.0 or above to access the Industrial Managed Switch.

### 3. Wiring the Power Inputs

The Upper Panel of the **Industrial Managed Switch** indicates a DC inlet power socket and consists of one terminal block connector within 6 contacts. Please follow the steps below to insert the power wire.

1. Insert positive / negative DC power wires into contacts 1 and 2 for Power 1, or 5, and 6 for Power 2.

■ **IGS-10020MT**: DC 12~48V, AC 24V

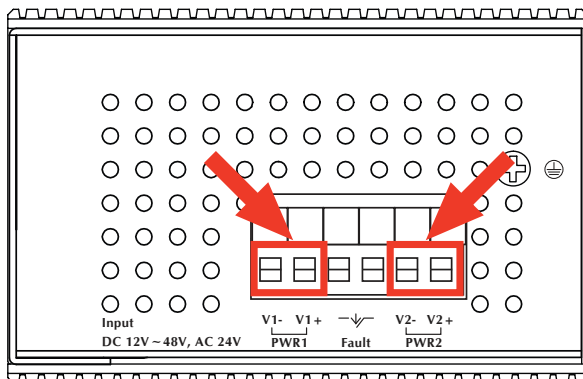


Figure 3-1: IGS-10020MT Upper Panel

■ **IGS-10020PT / IGS-10020HPT**: DC 48V

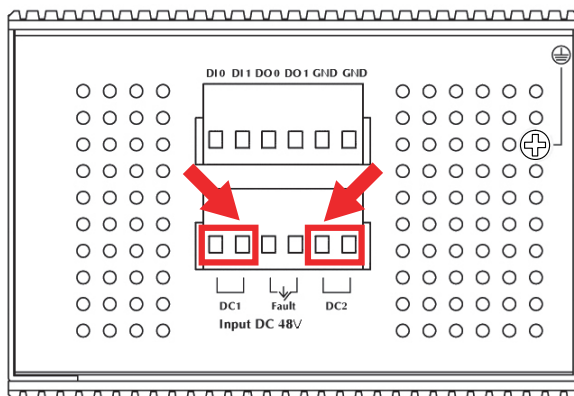
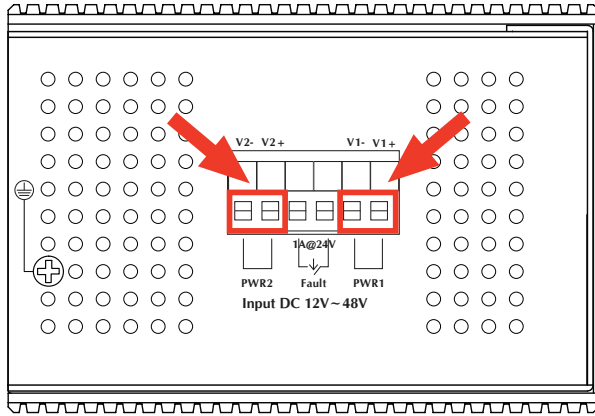


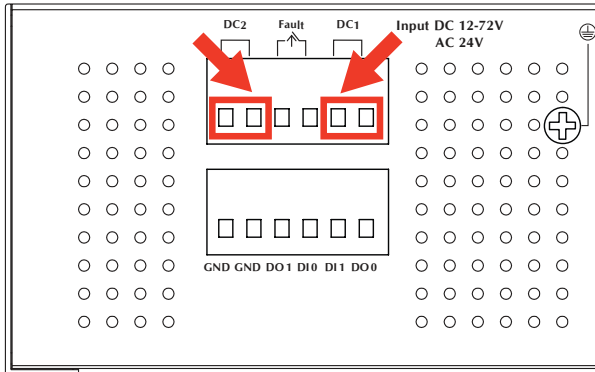
Figure 3-2: IGS-10020PT / IGS-10020HPT Upper Panel

■ **IGS-10080MFT:** DC 12~48V, AC 24V



**Figure 3-3:** IGS-10080MFT Upper Panel

■ **IGS-12040MT:** DC 12~72V, AC 24V



**Figure 3-4:** IGS-12040MT Upper Panel

■ **IGS-20040MT:** DC 12~48V, AC 24V

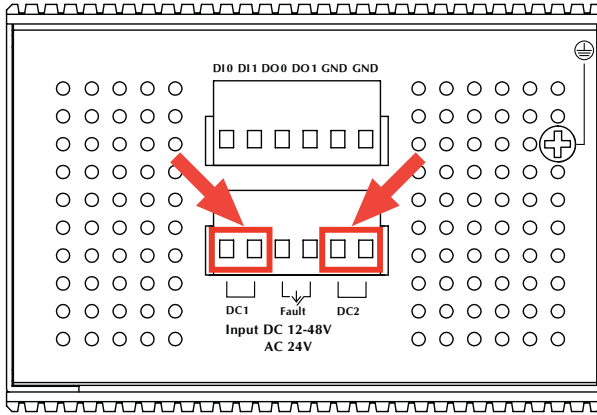


Figure 3-5: IGS-20040MT Upper Panel

■ **IGS-20160HPT:** DC 48~56V

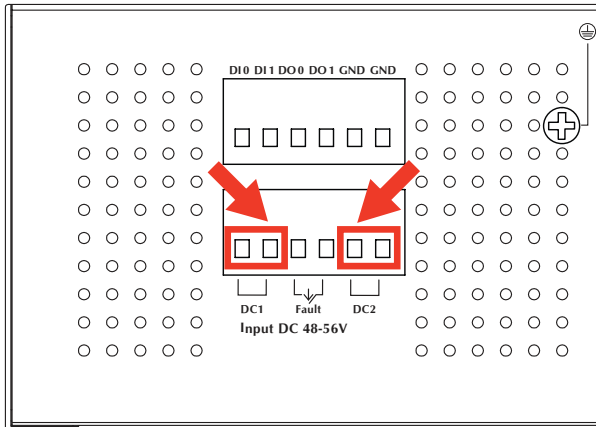
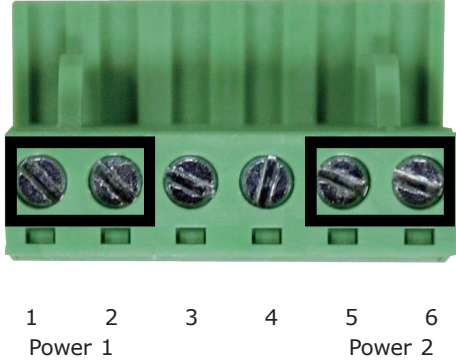


Figure 3-6: IGS-20160HPT Upper Panel



2. Tighten the wire-clamp screws for preventing the wires from loosening.



	Positive (+) Pin	Negative (-) Pin
IGS-10020MT	Pin 2 / 6	Pin 1 / 5
IGS-10020PT	Pin 1 / 5	Pin 2 / 6
IGS-10020HPT	Pin 1 / 5	Pin 2 / 6
IGS-10080MFT	Pin 1 / 5	Pin 2 / 6
IGS-12040MT	Pin 1 / 5	Pin 2 / 6
IGS-20040MT	Pin 1 / 5	Pin 2 / 6
IGS-20160HPT	Pin 1 / 5	Pin 2 / 6

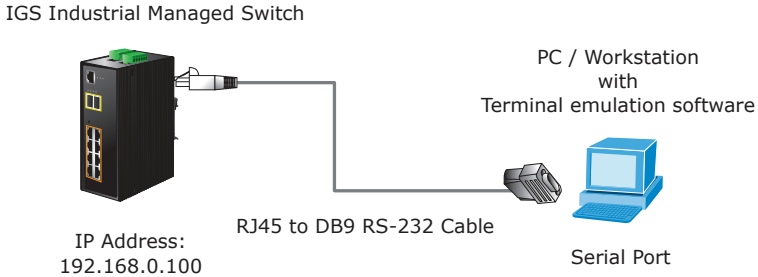


**Note**

The wire gauge for the terminal block should be in the range from 12 to 24 AWG.

## 4. Terminal Setup

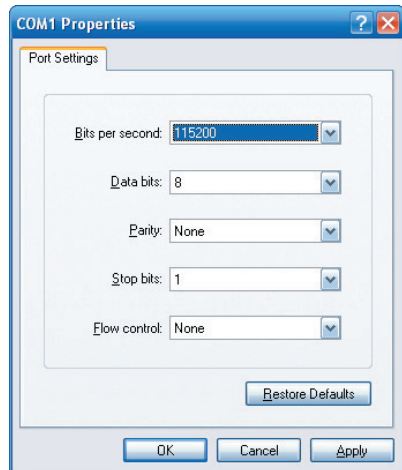
To configure the system, connect a serial cable to a **COM port** on a PC or notebook computer and to RJ45 type serial (console) port of the Managed Industrial Switch. The console port of the Industrial Managed Switch is DCE already, so that you can connect the console port directly through PC without the need of null modem.



A terminal program is required to make the software connected to the IGS Industrial Managed Switch. Windows' **Hyper Terminal** program may be a good choice. The Hyper Terminal can be accessed from the **Start** menu.

1. Click **START**, then **Programs, Accessories** and then **Hyper Terminal**.
2. When the following screen appears, make sure that the COM port should be configured as:

- ◆ Baud : 115200
- ◆ Parity : None
- ◆ Data bits : 8
- ◆ Stop bits : 1
- ◆ Flow Control : None



## 5. Logon to the Console

Once the terminal has been connected to the device, power on the Industrial Managed Switch and the terminal will display “running testing procedures”.



### Note

1. There are six switches with RJ45 type console connector. (IGS-10020PT / IGS-10020HPT / IGS-10080MFT / IGS-12040MT / IGS-20040MT / IGS-20160HPT)
2. Let's take IGS-20040MT for example.

When the following dialog box shown in Figure 5-1 appears, please enter the factory default user name “**admin**” and password “**admin**”.

User name: **admin**

Password: **admin**

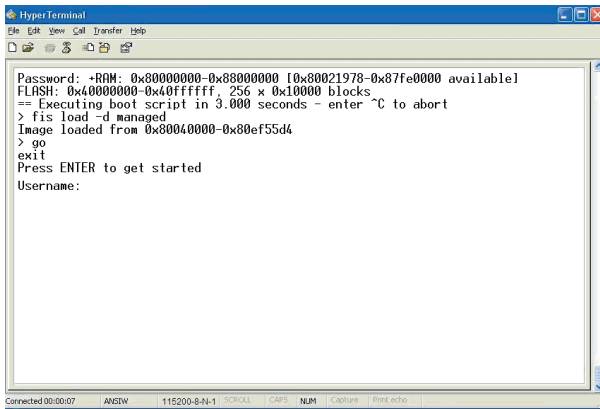


Figure 5-1: Console Login screen



### Note

1. For security reason, please change and memorize the new password after this first setup.
2. Only accept command in lowercase letter under console interface.

## 6. Configuring IP address

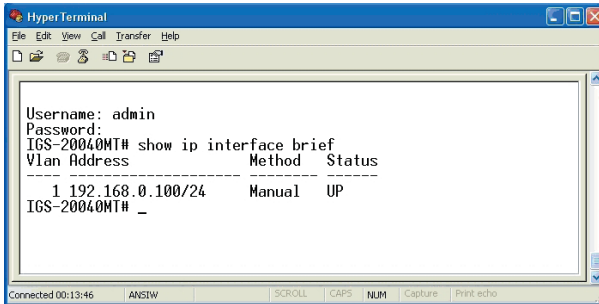
The Industrial Managed Switch is shipped with default IP address shown below:

IP Address: **192.168.0.100**  
Subnet Mask: **255.255.255.0**

To check the current IP address or modify a new IP address for the Switch, please use the procedures as follows:

### ■ Display of the current IP Address

1. At the “#” prompt, enter “**show ip interface brief**”.
2. The screen displays the current IP address shown in Figure 6-1.



```
Hyper Terminal
File Edit View Call Transfer Help
[Icons]
Username: admin
Password:
IGS-20040MT# show ip interface brief
Vlan Address          Method  Status
-----
1 192.168.0.100/24    Manual  UP
IGS-20040MT# _
```

Connected 00:13:46 ANSIW SCROLL CAPS NUM Capture Print-echo

Figure 6-1: IP Information Screen

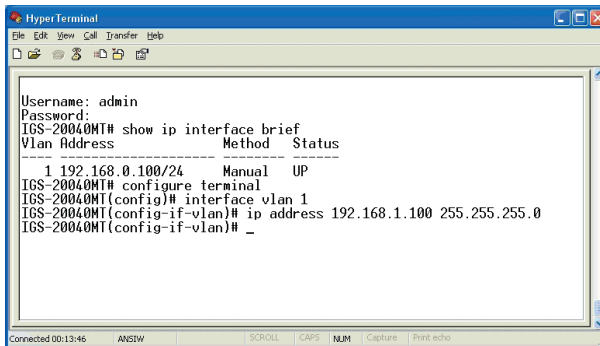
## ■ Configuration of the IP Address

3. At the “#” prompt, enter the following command and press **<Enter>** as shown in Figure 6-2.

```
IGS-20040MT# configure terminal
IGS-20040MT (config)# interface vlan 1
IGS-20040MT (config-if-vlan)# ip address 192.168.1.100 255.255.255.0
```

The previous command would apply the following settings for the Industrial Managed Switch.

```
IP Address: 192.168.1.100
Subnet Mask: 255.255.255.0
```



```
HyperTerminal
File Edit View Call Transfer Help
[Icons]
Username: admin
Password:
IGS-20040MT# show ip interface brief
Vlan Address          Method  Status
-----
1 192.168.0.100/24    Manual  UP
IGS-20040MT# configure terminal
IGS-20040MT(config)# interface vlan 1
IGS-20040MT(config-if-vlan)# ip address 192.168.1.100 255.255.255.0
IGS-20040MT(config-if-vlan)# _
Connected 00:13:46 ANS1W SCROLL CAPS NUM Capture Print echo
```

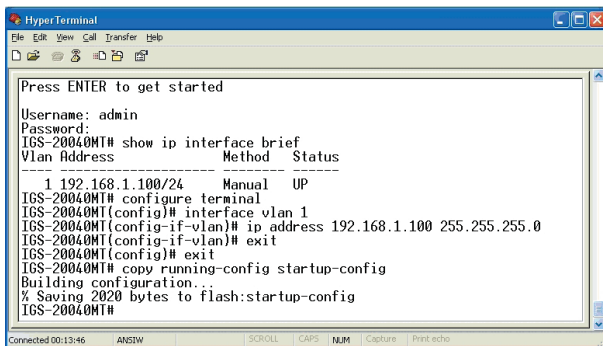
Figure 6-2: Configuring IP Address Screen

4. Repeat step 1 to check if the IP address is changed.

## ■ Store the current switch configuration

5. At the “#” prompt, enter the following command and press **<Enter>**.

**# copy running-config startup-config**



```
HyperTerminal
File Edit View Call Transfer Help
Press ENTER to get started
Username: admin
Password:
IGS-20040MT# show ip interface brief
Vlan Address Method Status
-----
1 192.168.1.100/24 Manual UP
IGS-20040MT# configure terminal
IGS-20040MT(config)# interface vlan 1
IGS-20040MT(config-if-vlan)# ip address 192.168.1.100 255.255.255.0
IGS-20040MT(config-if-vlan)# exit
IGS-20040MT(config)# exit
IGS-20040MT# copy running-config startup-config
Building configuration...
% Saving 2020 bytes to flash:startup-config
IGS-20040MT#
```

**Figure 6-3:** Saving Current Configuration Command Screen

If the IP is successfully configured, the Industrial Managed Switch will apply the new IP address setting immediately. You can access the Web interface of the Industrial Managed Switch through the new IP address.



**Note**

If you are not familiar with the console command or the related parameter, enter “**help**” anytime in console to get the help description.

## 7. Starting Web Management

The following shows how to start up the **Web Management** of the Industrial Managed Switch. Note the Industrial Managed Switch is configured through an Ethernet connection. Please make sure the manager PC must be set on the same **IP subnet address**.

For example, the default IP address of the Industrial Managed Switch is **192.168.0.100**, then the manager PC should be set at **192.168.0.x** (where x is a number between 1 and 254, except 100), and the default subnet mask is 255.255.255.0.

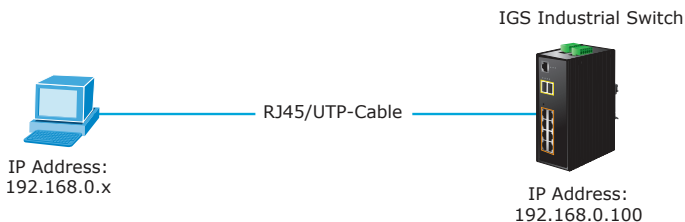


Figure 7-1: IP Management Diagram

### Logging in the Industrial Managed Switch

1. Use Internet Explorer 7.0 or above for Web browser and enter IP address **http://192.168.0.100** (the factory-default IP address) to access the Web interface.
2. When the following dialog box appears, please enter the default user name "**admin**" and password "**admin**" (or the password you have changed before) as shown in Figure 7-2.

Default IP Address: **192.168.0.100**  
Default User Name: **admin**  
Default Password: **admin**



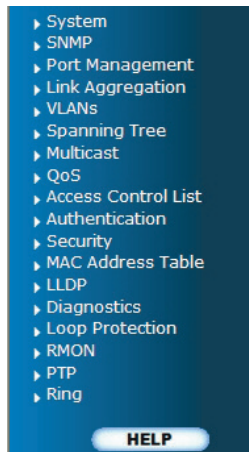
Figure 7-2: Login Screen

3. After entering the password, the main screen appears as shown in Figure 7-3.

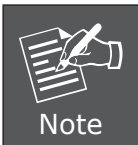


**Figure 7-3:** Web Main Screen of Industrial Managed Switch

4. The Switch Menu on the left of the Web page lets you access all the functions and status the Industrial Managed Switch provides.



Now, you can use the Web management interface to continue the Switch management. Please refer to the user manual for more.



For security reason, please change and memorize the new password after this first setup.



## 8. Resetting the Switch to Default

To reset the IP address to the default IP Address **“192.168.0.100”** and the user password to factory default mode (default password is **admin**), press the hardware reset button on the front panel for about 10 seconds. After the device is rebooted, you can login the management Web interface within the same subnet of 192.168.0.xx and default password. Be noted that all the previous setups will be disappeared after the factory default reset is made.

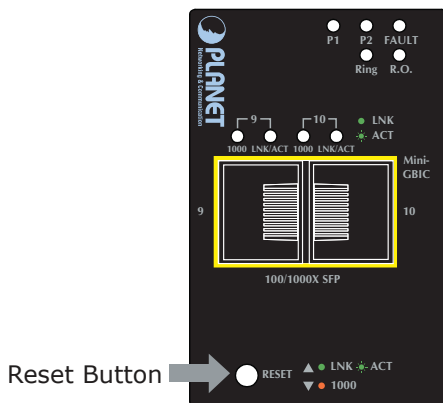


Figure 8-1: IGS-10020MT Reset Button

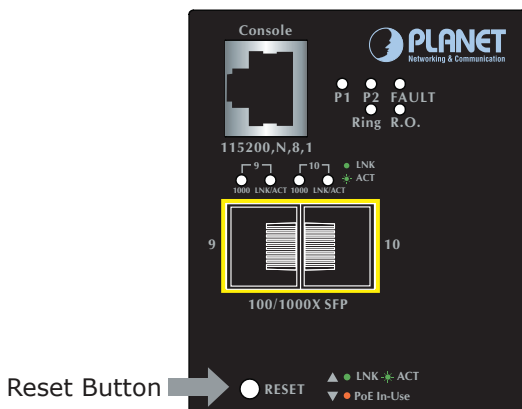
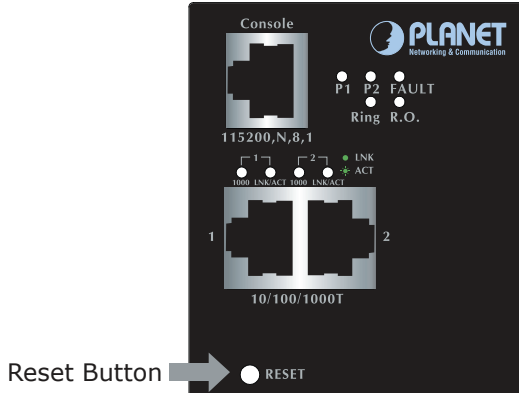
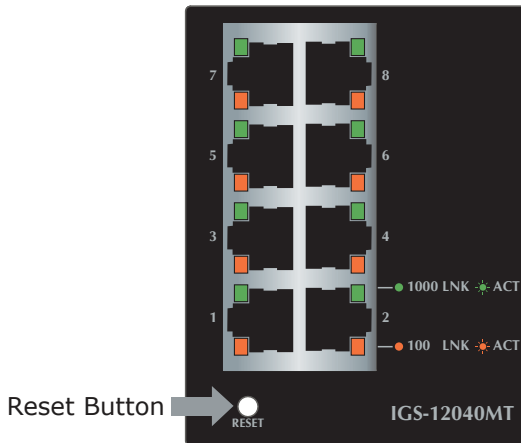


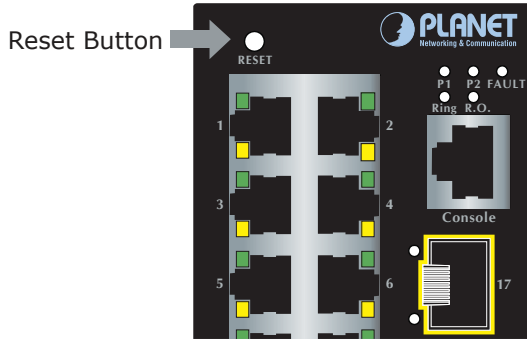
Figure 8-2: IGS-10020PT / IGS-10020HPT Reset Button



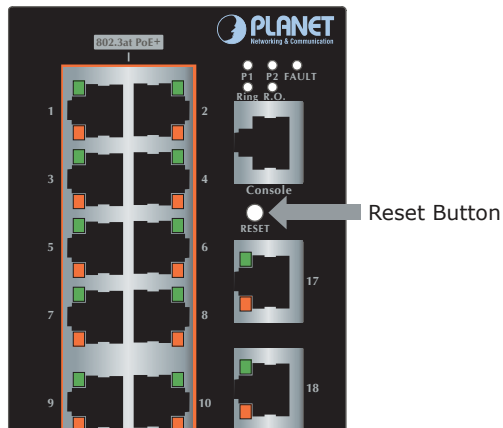
**Figure 8-3:** IGS-10080MFT Reset Button



**Figure 8-4:** IGS-12040MT Reset Button



**Figure 8-5:** IGS-20040MT Reset Button



**Figure 8-6:** IGS-20160HPT Reset Button

## 9. Customer Support

Thank you for purchasing PLANET products. You can browse our online FAQ resource on PLANET web site first to check if it could solve your issue. If you need more support information, please contact PLANET switch support team.

PLANET online FAQ :

<http://www.planet.com.tw/en/support/faq.php>

Switch support team mail address :

[support\\_switch@planet.com.tw](mailto:support_switch@planet.com.tw)

IGS-10020MT / IGS-10020PT / IGS-10020HPT / IGS-10080MFT / IGS-12040MT / IGS-20040MT / IGS-20160HPT User's Manual:

<http://www.planet.com.tw/en/support/download.php?type1=22153&model=&type=3>



(Please select your switch model name from the Product Model drop-down menu)

Copyright © PLANET Technology Corp. 2015.

Contents are subject to revision without prior notice.

PLANET is a registered trademark of PLANET Technology Corp.

All other trademarks belong to their respective owners.